

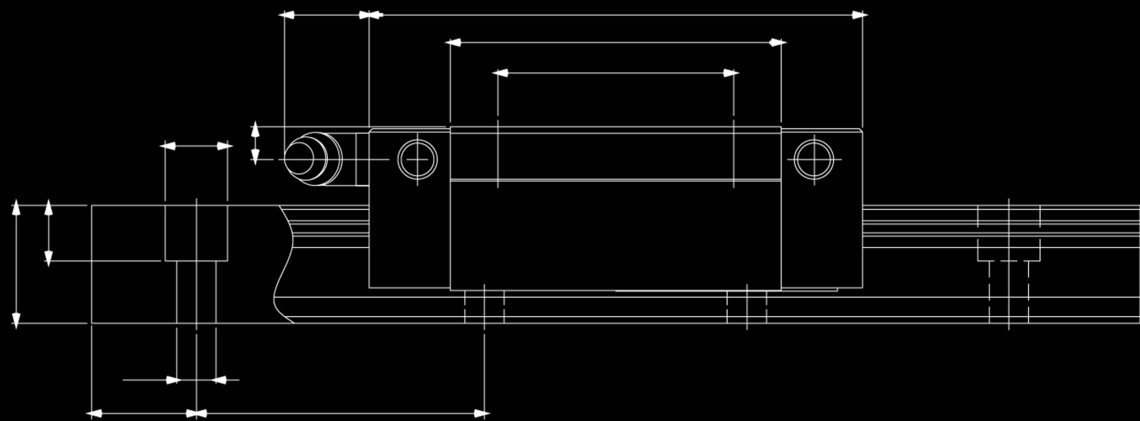

# LINEAR MOTION CATALOGUE



## High-quality High-performance **WON** Linear Motion Guide

WONST Linear Motion Guide has a four-row circular face-to-face duplex structure and 4-direction equal load type, which is excellent at bearing high load with high rigidity, auto-adjusting, and compatibility between a rail and a block, and allows smooth and precise operation.



High  
rigidity



High  
precision



Long life



Auto  
adjustment

**WON**



Low noise



Compatibility

### Linear Motion Guide - H series

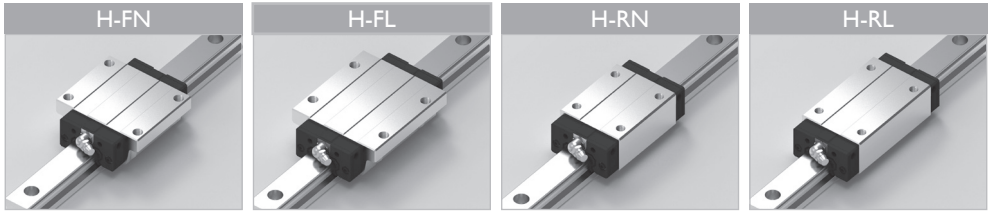

### Spacer Chain Guide - H...S series

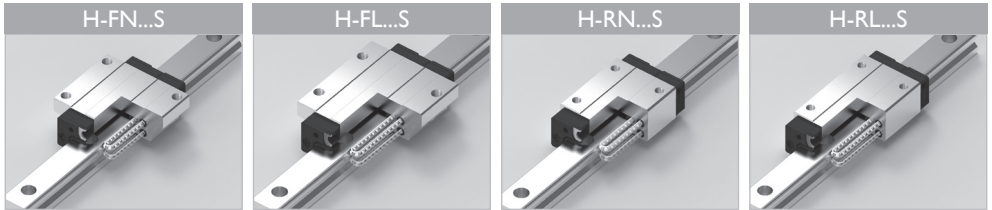

### Wide Linear Motion Guide - HB series

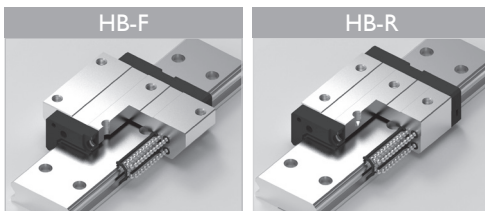

Slim Linear Motion Guide - S series

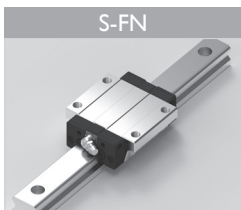
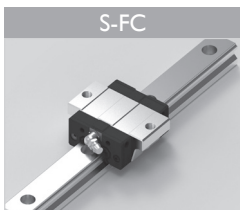
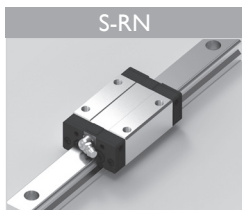
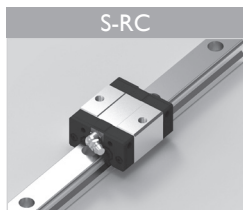

Slim Spacer Chain Guide - S...S series

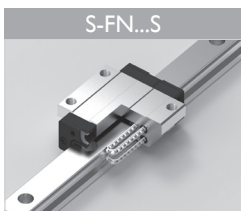
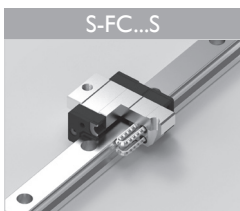
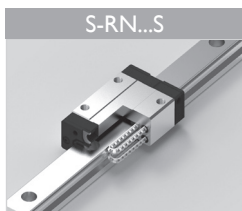

Slim Linear Motion Guide - HS series



Slim Spacer Chain Guide - HS...S series

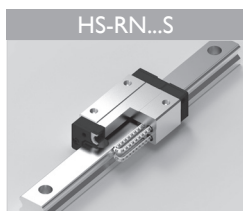

### Miniature Linear Motion Guide - M series

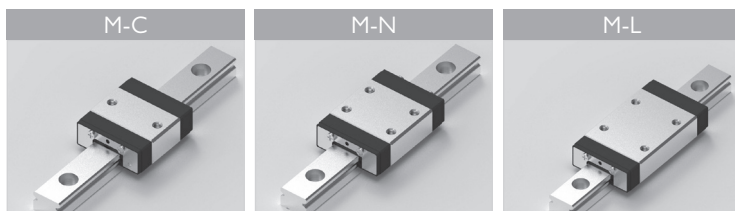

### Miniature Wide Linear Motion Guide - MB series

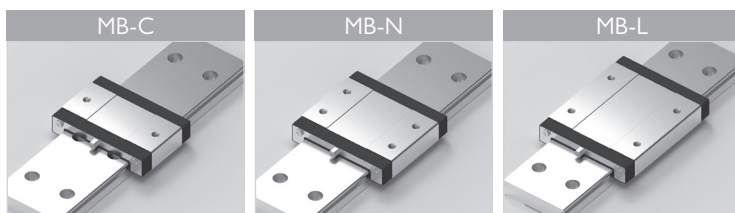

### Roller Linear Motion Roller Guide - R series

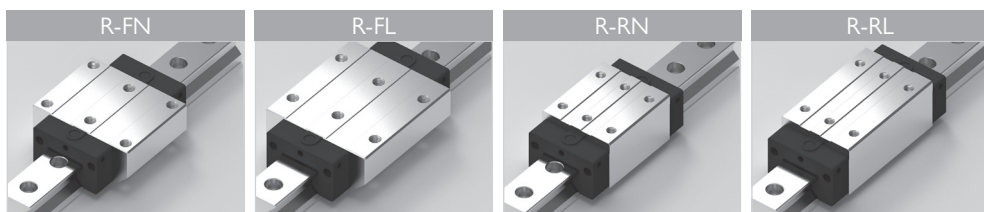

### Slim Roller Linear Motion Roller Guide - RS series

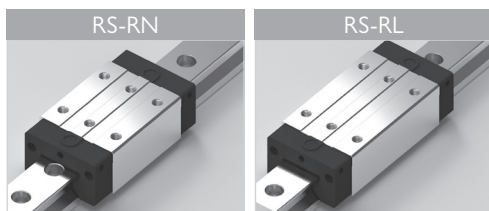

## Crossed Roller Bearing

CB

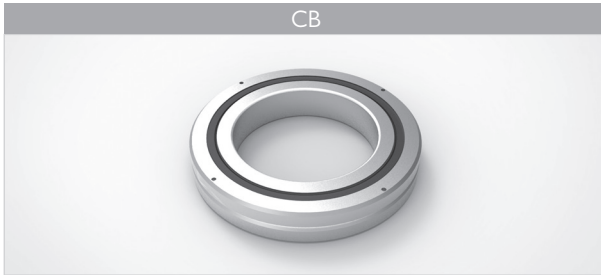

CH



CA



CS

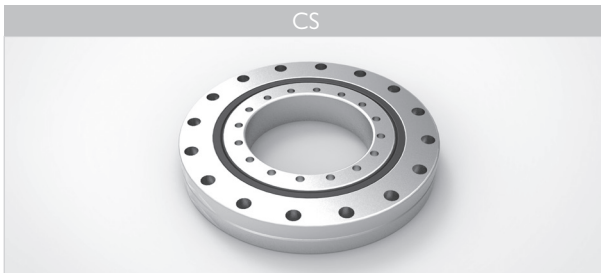

## Compact Ball Spline

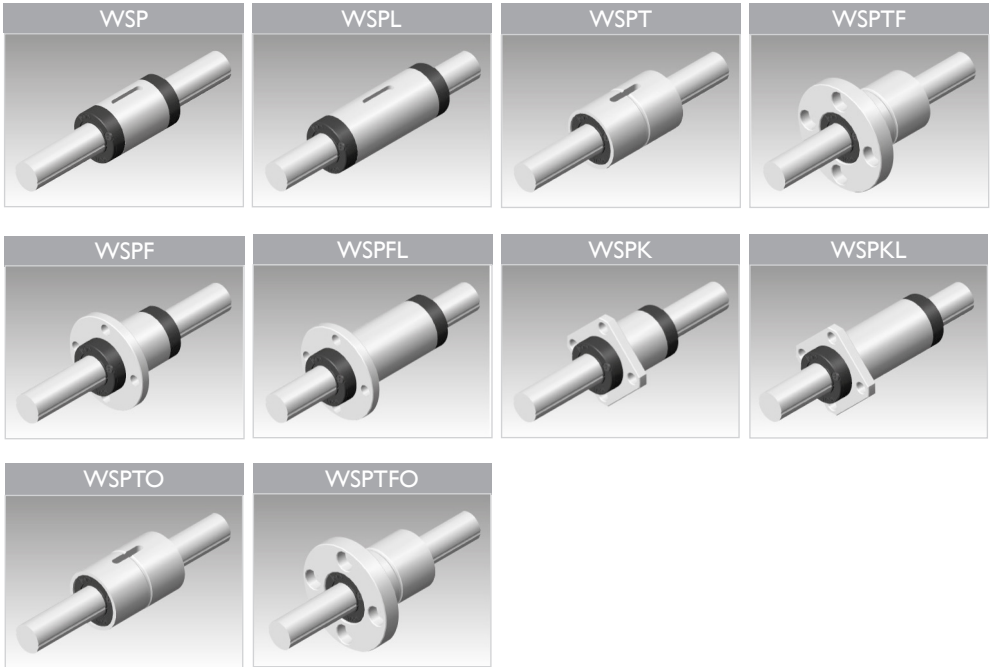

## Linear Ball Spline

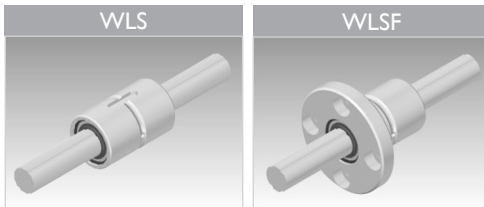

## Cross Roller Guide Way

WRG

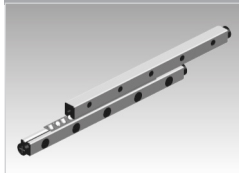

WRGO

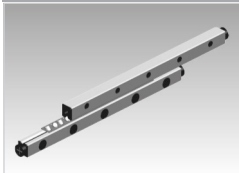

WRG-AC

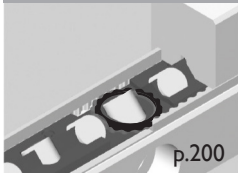

WRGW

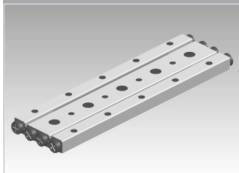

WRGT

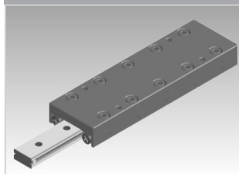

WRGT-B

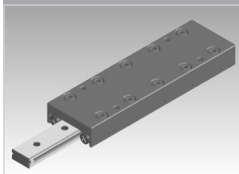

WRGU

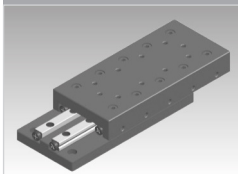

WRGU-AC

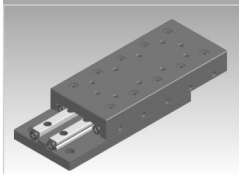



# Linear Motion Guide

## Contents

<b>1</b>	<b>Linear Motion Guide</b>	
1.	Features	14
2.	Strengths	14
3.	Types	15
<b>2</b>	<b>Selection of Linear Motion Guide</b>	
1.	Overview	16
2.	Procedure	16
<b>3</b>	<b>Life Calculation</b>	
1.	Load rating and life	17
2.	Load Calculation	18
3.	Service condition setting	18
4.	Load calculation formula	19
5.	Equivalent load calculation	23
6.	Equivalent load calculation formula	23
7.	Static safety factor calculation	24
8.	Mean load calculation	25
9.	Rating life calculation	26
<b>4</b>	<b>Rigidity &amp; Preload</b>	
1.	Preload	28
2.	Radial Clearance	29
<b>5</b>	<b>Friction</b>	
1.	Friction	31
2.	Friction coefficient	31
<b>6</b>	<b>Precision</b>	
1.	Precision specification	32
2.	Precision design	32
3.	Domension tolerance and difference	32
4.	Selection of precision class	36
<b>7</b>	<b>Lubrication</b>	
1.	Purpose	38
2.	Selection of lubricant	38
3.	Grease lubrication	39
4.	Oil lubrication	39
<b>8</b>	<b>Surface Treatment</b>	
1.	Surface treatment	40
2.	Types of surface treatment	40
<b>9</b>	<b>Dust Proof</b>	
1.	Dust proof	40
2.	Types of dust proof	40
<b>10</b>	<b>Measures for use in special environment</b>	41
<b>11</b>	<b>Placement &amp; Installation</b>	
1.	Placement and structure	42
2.	Mounting and fixing	43
3.	Design of the mounting surface	44
4.	Tolerance of the mounting side	47
5.	Description of the datum plane	50
6.	Rail connection	51
7.	Installation	52
8.	Torque used for fastening bolts	56
9.	Bolt fastening direction by linear motion guide	57
<b>12</b>	<b>Types of Linear Motion Guide</b>	
1.	Linear motion guide H series	58
2.	Spacer chain linear motion guide H..S Series	58
3.	Wide linear motion guide HB Series	70
4.	Slim linear motion guide S Series	76
5.	Slim spacer chain linear motion guide S Series	76
6.	Slim linear motion guide HS/HS..S Series	88
7.	Miniature linear motion guide M Series	94
8.	Wide miniature linear motion guide Series	94
9.	Roller linear motion guide R Series	102
<b>13</b>	<b>Options</b>	
1.	Seal and rail cap	112
2.	Oil inlet	116
3.	Grease nipple	117
4.	Connect of oil pipes	118
5.	How to install linear motion guide using a support rail	119
<b>14</b>	<b>Precautions for handling Linear Motion Guide</b>	
1.	Handling	120
2.	Lubrication	120
3.	Caution for use	120
4.	Storage	120

# Crossed Roller Bearing

## Contents

<b>1</b>	<b>Structure and Features of crossed roller bearing</b>		<b>8</b>	<b>Cautions in designing compression plate and housing</b>	
	1. Structure	124		1. Housing design for installation	132
	2. Features	124		2. Tap for separation	132
	3. Use	124		3. Installation and assembly	133
<b>2</b>	<b>Types of crossed roller bearing</b>			4. Selection of compression flange and bolt	133
	1. CB Series for revolving inner ring	125		5. Assembly procedure for installation	134
	2. CH Series with high stiffness	125	<b>9</b>	<b>Fitting</b>	135
	3. CA Series for slim revolving inner ring	126			
	4. Customized Special Type CS Series	126	<b>10</b>	<b>Precision specification of crossed roller bearing</b>	136
<b>3</b>	<b>Selection of crossed roller bearing</b>				
	1. Overview	127	<b>11</b>	<b>Precision specification of WUP-class Series</b>	
	2. Procedure	127		1. Rotational precision of WUP-class series	140
<b>4</b>	<b>Life Calculation</b>			2. Precision specification	140
	1. Rated service life (L)	128	<b>12</b>	<b>Radial clearance</b>	140
	2. Life calculation under heaving operation condition	129			
	3. Static safety factor ( $f_s$ )	129	<b>13</b>	<b>Dimensions of crossed roller bearing</b>	
	4. Static equivalent radial load ( $p_o$ )	130		1. CB Series	142
	5. Dynamic equivalent radial load ( $p_d$ )	130		2. CH Series	144
	6. Load factor ( $f_w$ )	131		3. CA Series	146
	7. Temperature factor ( $f_r$ )	131	<b>14</b>	<b>Precautions for handling crossed roller bearing</b>	147
<b>5</b>	<b>Rated Load</b>				
	1. Basic dynamic load rating	131			
	2. Basic static load rating	131			
<b>6</b>	<b>Permissible RPM</b>	132			
<b>7</b>	<b>Lubrication</b>	132			

# Ball Spline

## Contents

<b>1 Ball Spline</b>		<b>6 Lubrication and Dust proof</b>	160
1. Structure and Features	150		
2. Transmission of high torque	150		
3. High load capacity and long	150		
4. Zero gap	150		
<b>2 Selection of Ball Spline</b>		<b>7 Assembly</b>	161
1. Overview	151		
2. Procedure	151		
<b>3 Life Calculation</b>		<b>8 Caution for Use</b>	161
1. Life	152		
2. Rating fatigue life (L)	152		
3. Static safety factor ( $f_s$ )	154		
4. Basic dynamic load rating (C)	154		
5. Basic static load rating (Co)	155		
6. Basic dynamic rating torque (T)	155		
7. Basic static rating torque (To)	155		
Basic static rating moment (Tm)	155		
<b>4 Preload</b>	156		
<b>5 Precision</b>	157	<b>9 Compact Ball Spline</b>	
		1. Structure and Features	162
		2. Transmission of high torque	162
		3. High load capacity and long life	162
		<b>10 Linear Ball Spline</b>	
		1. Structure and Features	182
		2. High load capacity and long life	182
		3. Torque transmission with high precision	182
		4. High speed movement and high speed rotation	182
		5. Product components	182
		6. Easy further processing	182

# Cross Roller Guide Way

## Contents

<b>1</b>	<b>Structure and Features of crossed guide way</b>	
	1. Precise and fine linear motion	190
	2. Low Noise	190
	3. High load capacity	190
<b>2</b>	<b>Structure and Features of anti-creep cross roller guide way</b>	
	1. Responses to multiple types of operation	191
	2. Low noise and smooth motion	191
	3. High load capacity based on complete compatibility of installation dimensions	191
<b>3</b>	<b>Types and Features</b>	192
<b>4</b>	<b>Precision</b>	193
<b>5</b>	<b>Load rating and life</b>	194
<b>6</b>	<b>Preload</b>	196
<b>7</b>	<b>Precision of mounting surface</b>	197
<b>8</b>	<b>How to install</b>	197
<b>9</b>	<b>Lubrication and Dust proof</b>	199
<b>10</b>	<b>Caution for Use</b>	200



**WON**  
LINEAR MOTION SYSTEM

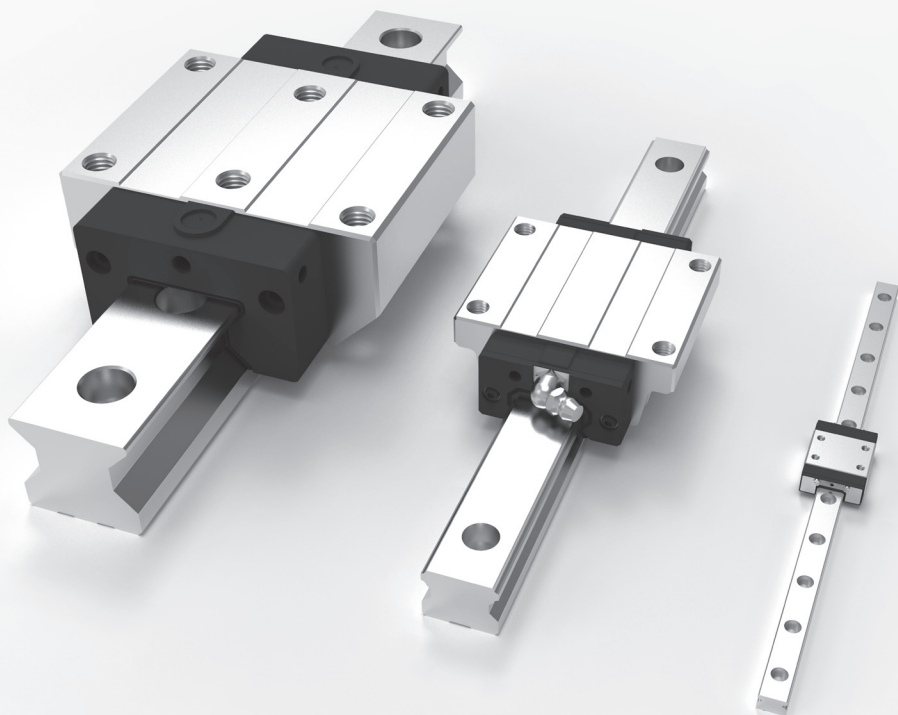

## LINEAR MOTION GUIDE

# WON Linear Motion Guide

## I. Features

Linear Motion Guide is a linear motion bearing with the structure in which rolling elements such as balls or rollers softly circulate the inner part of a block that can make an infinite linear motion along the raceway surface of a rail.

The device is able to do rolling motion ideally, bearing high load and 4-direction equal load with high rigidity. With its auto-adjusting ability, the linear motion guide is excellent at error-absorbing and improves its precision after assembly. Since it has low frictional force and less abrasion, it is possible to maintain precision long and to drive silently at high-speed running.

## 2. Strengths

1) Able to make precise positioning

Since there is less difference between static friction and kinetic friction as well as in speed-induced friction fluctuation, it excellently responds even to micro-migration, allowing precise positioning and high-speed running.

2) Able to maintain stable precision for a long time

Less friction coefficient and wear due to ideal rolling motion makes it possible to maintain stable precision for a long time.

3) Able to eliminate clearance or increase rigidity by preloading

It is possible to eliminate clearance by using rolling elements such as a ball or a roller, or to increase rigidity of Linear Motion Guide by preloading.

4) Simple lubrication

Lubrication is simple, and it is convenient to maintain the device with grease or oil.

5) Able to make compact equipment and save the cost for operating electricity

The device is able to bear high load with high rigidity and has low friction. Therefore, it is possible to design compact and miniaturized equipment and to save manufacturing costs and energy.

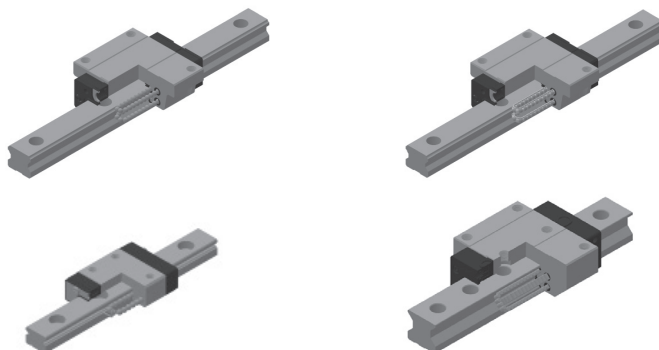

### 3. Types

WON ST offers various types of linear motion guide from miniature types to general ball linear motion guide to low-noise linear motion guide to ultra-high rigid roller linear motion guide. Since each one supports different shapes and sizes according to service conditions, you can select the optimal linear motion guide suitable for each usage.

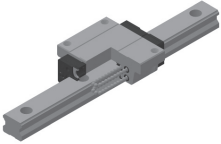
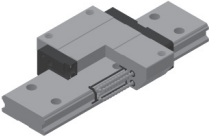
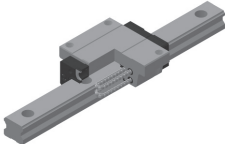
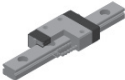
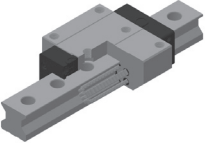
<p>Linear Motion Guide</p>		<ul style="list-style-type: none"> <li>•World standard ball linear motion guide</li> <li>•4-direction equal load type with 45° contact angle</li> <li>•Great error-absorbing ability with D/F combination</li> <li>•Linear motion with high rigidity and high precision through ideal rolling motion</li> </ul>
<p>Wide Linear Motion Guide</p>		<ul style="list-style-type: none"> <li>•4-direction equal load type with 45° contact angle; a low-centered structure with a wide and short rail; the moment working at a narrow space; usable as an one-axis type where high rigidity is required; a device with linear motion</li> </ul>
<p>Spacer Chain Linear Motion Guide</p>		<ul style="list-style-type: none"> <li>•World standard ball linear motion guide</li> <li>•4-direction equal load type with 45° contact angle</li> <li>•Great error-absorbing ability with D/F combination</li> <li>•A spacer ball chain based retainer type; a linear motion device generating low noise and low dust</li> </ul>
<p>Miniature Linear Motion Guide</p>		<ul style="list-style-type: none"> <li>•Miniature high-rigidity</li> <li>•Various shapes and sizes</li> <li>•A compact linear motion device with high durability and reliability</li> </ul>
<p>Roller Linear Motion Guide</p>		<ul style="list-style-type: none"> <li>•Roller-enabled ultra-rigid linear motion guide</li> <li>•4-direction equal load type with 45° contact angle</li> <li>•Able to run reliably for a long time through rolling motion having the wide contact surface</li> <li>•A linear motion device with high rigidity and</li> </ul>















## 2 Selection of Linear Motion Guide

### I. Overview

To select a linear motion guide, it is necessary to identify the details of requirements, prioritize them, and then choose the one that meets the service conditions.

### 2. Procedure

- |           |   |   |
|-----------|---|---|
| <b>1</b>  | <b>Identify service conditions</b>                    |  equipment, maintenance structure, installation space, assembly status, functional requirements, service conditions  |
| <b>2</b>  | <b>Select a type of Linear Motion Guide</b>           |  Select an appropriate type by considering motion condition, load level, rigidity, friction, and assembly.   |
| <b>3</b>  | <b>Select the model number of Linear Motion guide</b> |  Determine a model number and a quantity of blocks by considering such factors as assembly space and load.   |
| <b>4</b>  | <b>Calculate loads</b>                                |  Calculate the loads of the vertical and horizontal directions and moment, which are imposed on a block.   |
| <b>5</b>  | <b>Calculate equivalent load</b>                      |  Convert each load imposed on a block into an equivalent load.   |
| <b>6</b>  | <b>Calculate mean load</b>                            |  Convert each load imposed on a block and the variable load during acceleration or deceleration into a mean load   |
| <b>7</b>  | <b>Calculate static safety factor</b>                 |  Calculate a static safety factor identified with basic load rating and max. equivalent load. Check if it fits for service conditions.  |
| <b>8</b>  | <b>Calculate life</b>                                 |  Calculate a rated load and a life span. Check if the calculated life span fits for service conditions.  |
| <b>9</b>  | <b>Review preload &amp; clearance</b>                 |  Select the preload and clearance suitable for service conditions.   |
| <b>10</b> | <b>Determine the class of precision</b>               |  Determine a class of driving precision required by Linear Motion guide  |
| <b>11</b> | <b>Lubrication, dust proof, surface handling</b>      |  Select the lubricant suitable for the environment using grease, oil, or special grease lubrication. Select a dustproof seal. Determine the surface treatment for rust prevention for generating low dust. |
| <b>12</b> | <b>Complete selection</b>                             |  Decide the final specifications of Linear Motion guide.   |

## 3 Life Calculation

### I. Load rating and life

#### 1) Life

If external load is applied to linear motion guide in driving, fatigue fracture occurs due to the stress made as load is repeatedly applied to the raceway surface and rolling elements, and peeling off scale-like flakes (flaking) arises. Life of a linear motion guide refers to a total driving distance until the point that flaking arises due to initial fatigue fracture.

• A linear motion guide can have defects earlier than the time of normal flaking caused by its wear or fatigue in the following cases:

- a. Excess load by the imprecise assembly following a difference in temperature or tolerance
- b. If a linear motion guide is contaminated with foreign substances
- c. Driving with insufficient lubrication
- d. Reciprocating motion in a very short distance in the form of vibration or wave during halting or driving
- e. Excessive load imposed on a linear motion guide
- f. Deformation of plastic end-plate

#### 2) Rating fatigue life L

Generally linear motion guide does not always have an equal life span even though its products are manufactured in the same way, because of the difference in scattering of original fatigue of rawmaterial. For this reason, the reference value of life of a linear motion guide is defined as the rating fatigue life which is a total driving distance that 90% of linear motion guides in one group with the same specifications can reach without flaking at the time when all in the group run under the same conditions.

When using a ball

$$L = \left( \frac{f_H \cdot f_T \cdot f_C}{f_W} \cdot \frac{C}{P_C} \right)^3 \times 50$$

When using a roller

$$L = \left( \frac{f_H \cdot f_T \cdot f_C}{f_W} \cdot \frac{C}{P_C} \right)^{\frac{10}{3}} \times 100$$

#### 3) Basic dynamic load rating C

Basic dynamic load rating is a ability of linear motion guide to bear load, which represents an applicable constant load in direction and magnitude when the rated fatigue life is 50Km. The reference value of basic of WON linear motion guide dynamic load rating is 50Km (ball type) and 100Km (roller type), respectively. It is used for calculating of life a linear motion guide while driving under constant load in magnitude from the center of a block to bottom. Each value of basic dynamic load rating (C) is described in the catalogue

#### 4) Basic static load rating C<sub>0</sub>

If a linear motion guide is applied by excessive load or instantly by big impact load, partially permanent deformation occurs between a rolling element and the raceway surface. If deformation reaches to a certain extent, it hinders smooth driving.

Basic static load rating is defined as the constant static load in direction and magnitude when the total permanent deformation of the raceway surface of block and rail and of a rolling element like a ball or a roller is 0.0001 times bigger than the diameter of the rolling element. In a linear motion guide, it refers to the load applied from top to bottom based on the center of a block.

Each value of basic static load rating (C<sub>0</sub>) is described in the specification table.

5) Static allowable moment  $M_0$

Moment load can be imposed on a linear motion guide. At this time, a ball or a roller both at the ends is most stressed due to the stress distribution of a ball or a roller as a rolling element in the linear motion guide. Static allowable moment ( $M_0$ ) refers to the constant moment load in direction and magnitude when the total permanent deformation of a ball or roller; a rolling element to which the biggest stress is applied, and of the raceway surface of a block or rail is less than 0.0001 of the diameter of the rolling element. Moment values of three directions ( $M_p, M_y, M_r$ ) are described in the catalogue. Static allowable moment ( $M_0$ ) and static moment load rating ( $M_p$ ) can be reviewed with application of safety factor ( $f_s$ )

Directions of load and moment

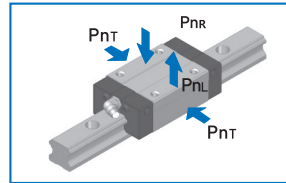
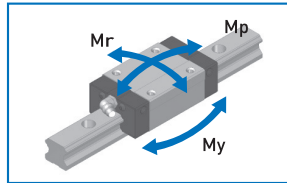

$$f_s = \frac{M_p}{M_0}$$

## 2. Load calculation

A linear motion guide bears basic dynamic load rating (C) and basic static load rating ( $C_0$ ). Nevertheless, it also needs to bear compression load applied from top to down due to inertia force created by the center of gravity, positioning thrust, acceleration, cutting force, and deceleration as well as various loads including tensile load, horizontal load, and moment load, depending on the service conditions. In this case, load of the linear motion guide changes. To select a linear motion guide, it is required to review these conditions and calculate a proper load.

## 3. Service condition setting

Service conditions necessary for calculating the load and life of a linear motion guide.

- |   |                |  |                 |  |
|---|----------------|--|-----------------|--|
| <input type="checkbox"/> Mass :                               | m(kg)          | <input type="checkbox"/> Velocity diagram                          | Velocity :      | V(mm/s)  |
| <input type="checkbox"/> Applicable load direction :          |                |  | Time constant : | tn(s)  |
| <input type="checkbox"/> Point of application :               | l2, l3, h1(mm) |  | Acceleration :  | <input type="checkbox"/> n(mm/s <sup>2</sup> ) |
| (center of gravity)   |                | <input type="checkbox"/> No. of reciprocating motions per minute : |                 | N1(min <sup>-1</sup> )                         |
| <input type="checkbox"/> Point of thrust :                    | l4, h2(mm)     | <input type="checkbox"/> Stroke :                                  |                 | Ls(mm)   |
| <input type="checkbox"/> Composition of linear motion guide : | l0, l1(mm)     | <input type="checkbox"/> Avg. velocity :                           |                 | Vm(m/s)  |
| (No. of blocks & rails)                                       |                | <input type="checkbox"/> Required life :                           |                 | Lh(h)  |

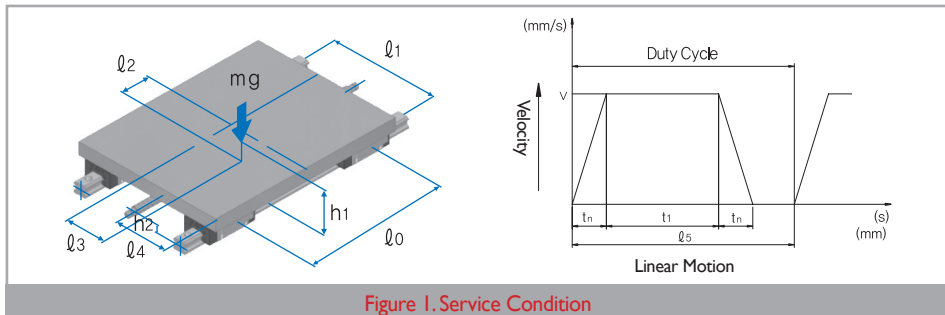
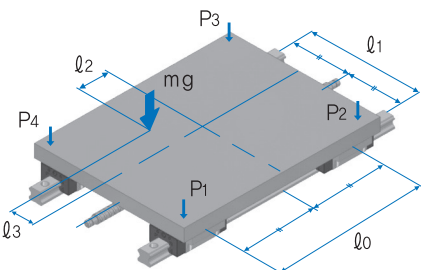
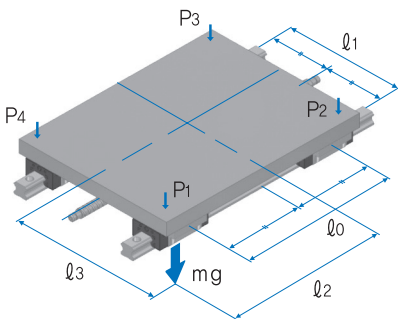

Figure 1. Service Condition

## 4. Load calculation formula

The load applied to a linear motion guide changes depending on external forces such as the center of gravity, position of thrust, acceleration, and cutting resistance. To select a linear motion guide, it is required to calculate the load applied to a block in full consideration of the conditions shown below.

$m$ : Mass	(kg)	$g$ : Acceleration of gravity ( $g : 9.8m/s^2$ )	( $m/s^2$ )
$l_n$ : Mass	(mm)	$V$ : Velocity	(m/s)
$F_n$ : Thrust	(N)	$t_n$ : Time constant	(s)
$P_n$ : Load (vertical, reverse-vertical)	(N)	$\square_n$ : Velocity	( $m/s^2$ )
$P_{nr}$ : Load (horizontal)	(N)		

Case	Service Conditions	Load Calculation Formula
1	<p>Block move Horizontal / uniform motion / stationary</p> 	$P_1 = \frac{mg}{4} + \frac{mg \cdot l_2}{2 \cdot l_0} - \frac{mg \cdot l_3}{2 \cdot l_1}$ $P_2 = \frac{mg}{4} - \frac{mg \cdot l_2}{2 \cdot l_0} - \frac{mg \cdot l_3}{2 \cdot l_1}$ $P_3 = \frac{mg}{4} - \frac{mg \cdot l_2}{2 \cdot l_0} + \frac{mg \cdot l_3}{2 \cdot l_1}$ $P_4 = \frac{mg}{4} + \frac{mg \cdot l_2}{2 \cdot l_0} + \frac{mg \cdot l_3}{2 \cdot l_1}$
2	<p>Block move Overhang-Horizontal / uniform motion / stationary</p> 	$P_1 = \frac{mg}{4} + \frac{mg \cdot l_2}{2 \cdot l_0} + \frac{mg \cdot l_3}{2 \cdot l_1}$ $P_2 = \frac{mg}{4} - \frac{mg \cdot l_2}{2 \cdot l_0} + \frac{mg \cdot l_3}{2 \cdot l_1}$ $P_3 = \frac{mg}{4} - \frac{mg \cdot l_2}{2 \cdot l_0} - \frac{mg \cdot l_3}{2 \cdot l_1}$ $P_4 = \frac{mg}{4} + \frac{mg \cdot l_2}{2 \cdot l_0} - \frac{mg \cdot l_3}{2 \cdot l_1}$

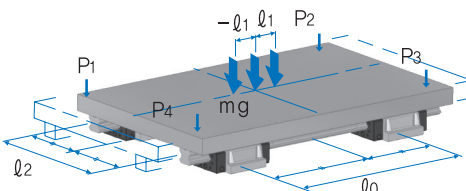
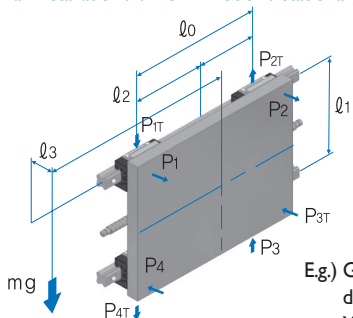
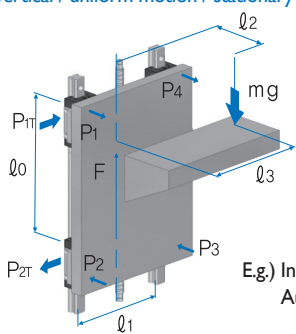
Case	Service Conditions	Load Calculation Formula
3	<p>Rail move Horizontal / uniform motion / stationary</p>  <p>E.g.) X or Z axis Loader / unLoader</p>	$P_1 = \frac{mg \cdot \cos \theta}{4} + \frac{mg \cdot \cos \theta \cdot l_2}{2 \cdot l_0}$ $- \frac{mg \cdot \cos \theta \cdot l_3}{2 \cdot l_1} + \frac{mg \cdot \sin \theta \cdot h_1}{2 \cdot l_1}$ $P_{1T} = \frac{mg \cdot \sin \theta}{4} + \frac{mg \cdot \sin \theta \cdot l_2}{2 \cdot l_0}$ $P_2 = \frac{mg \cdot \cos \theta}{4} - \frac{mg \cdot \cos \theta \cdot l_2}{2 \cdot l_0}$ $- \frac{mg \cdot \cos \theta \cdot l_3}{2 \cdot l_1} + \frac{mg \cdot \sin \theta \cdot h_1}{2 \cdot l_1}$ $P_{2T} = \frac{mg \cdot \sin \theta}{4} - \frac{mg \cdot \sin \theta \cdot l_2}{2 \cdot l_0}$
4	<p>Block move Wall installation / uniform motion / stationary</p>  <p>E.g.) Gantry-type device Y-axis drive</p>	$P_1 \sim P_4 = \frac{mg \cdot l_3}{2 \cdot l_1}$ $P_{1T} = P_{4T} = \frac{mg}{4} + \frac{mg \cdot l_2}{2 \cdot l_0}$ $P_{2T} = P_{3T} = \frac{mg}{4} - \frac{mg \cdot l_2}{2 \cdot l_0}$
5	<p>Block move Vertical / uniform motion / stationary</p>  <p>E.g.) Industrial robot, Z-axis, Auto-painting spray, Lifter</p>	$P_1 \sim P_4 = \frac{mg \cdot l_2}{2 \cdot l_0}$ $P_{1T} \sim P_{4T} = \frac{mg \cdot l_3}{2 \cdot l_0}$

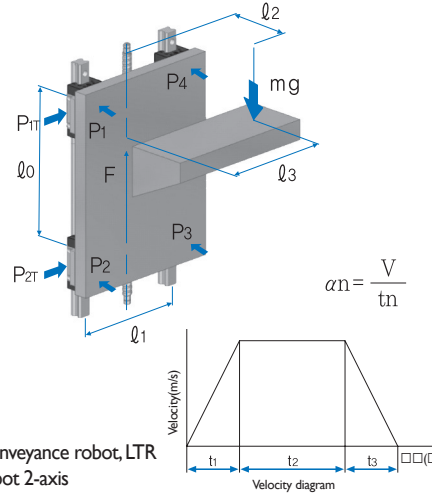
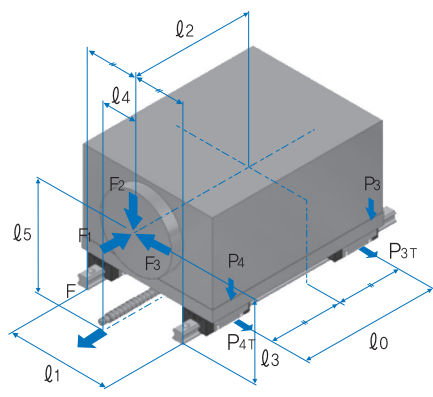
Case	Service Conditions	Load Calculation Formula
6	<p>Block move Vertical/moment of inertia</p>  <p>E.g.) Conveyance robot, LTR robot 2-axis</p>	<p><b>Acceleration</b></p> $P_1=P_4 = - \frac{m(g-\alpha)\ell_2}{2 \cdot \ell_0}$ $P_2=P_3 = \frac{m(g-\alpha)\ell_2}{2 \cdot \ell_0}$ $P_{1T}=P_{4T} = - \frac{m(g-\alpha)\ell_3}{2 \cdot \ell_0}$ $P_{2T}=P_{3T} = - \frac{m(g-\alpha)\ell_3}{2 \cdot \ell_0}$ <p><b>Constant Velocity</b></p> $P_1=P_4 = - \frac{mg \cdot \ell_2}{2 \cdot \ell_0}$ $P_2=P_3 = \frac{mg \cdot \ell_2}{2 \cdot \ell_0}$ $P_{1T}=P_{4T} = - \frac{mg \cdot \ell_3}{2 \cdot \ell_0}$ $P_{2T}=P_{3T} = - \frac{mg \cdot \ell_3}{2 \cdot \ell_0}$ <p><b>Deceleration</b></p> $P_1=P_4 = - \frac{m(g-\alpha_3)\ell_2}{2 \cdot \ell_0}$ $P_2=P_3 = \frac{m(g-\alpha_3)\ell_2}{2 \cdot \ell_0}$ $P_{1T}=P_{4T} = - \frac{m(g-\alpha_3)\ell_3}{2 \cdot \ell_0}$ $P_{2T}=P_{3T} = - \frac{m(g-\alpha_3)\ell_3}{2 \cdot \ell_0}$
7	<p>Block move Complex external loads like cutting load</p>  <p>E.g.) Machine tool, CNC lathe, Machining center, NC milling machine</p>	<p><b>F1 application</b></p> $P_1=P_4 = - \frac{F_1 \cdot \ell_5}{2 \cdot \ell_0}$ $P_2=P_3 = \frac{F_1 \cdot \ell_5}{2 \cdot \ell_0}$ $P_{1T}=P_{4T} = - \frac{F_1 \cdot \ell_4}{2 \cdot \ell_0}$ $P_{2T}=P_{3T} = - \frac{F_1 \cdot \ell_4}{2 \cdot \ell_0}$ <p><b>F2 application</b></p> $P_1=P_4 = \frac{F_2}{4} - \frac{F_2 \cdot \ell_2}{2 \cdot \ell_0}$ $P_2=P_3 = \frac{F_2}{4} + \frac{F_2 \cdot \ell_2}{2 \cdot \ell_0}$ <p><b>F3 application</b></p> $P_1=P_4 = - \frac{F_3 \cdot \ell_3}{2 \cdot \ell_1}$ $P_2=P_3 = \frac{F_3 \cdot \ell_3}{2 \cdot \ell_1}$ $P_{1T}=P_{4T} = \frac{F_3}{4} - \frac{F_3 \cdot \ell_2}{2 \cdot \ell_0}$ $P_{2T}=P_{3T} = \frac{F_3}{4} + \frac{F_3 \cdot \ell_2}{2 \cdot \ell_0}$

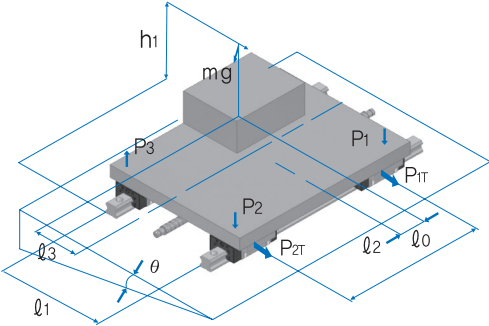
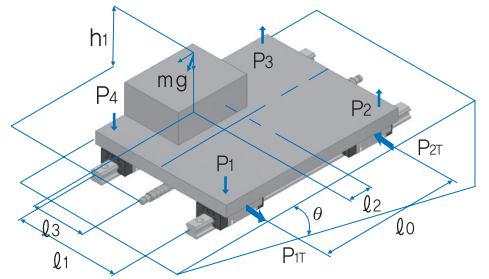
Case	Service Conditions	Load Calculation Formula
8	<p>Block move Moment load in case of application to side slope / cutting load</p> 	$P_1 = \frac{mg \cdot \cos \theta}{4} + \frac{mg \cdot \cos \theta \cdot l_2}{2 \cdot l_0} - \frac{mg \cdot \cos \theta \cdot l_3}{2 \cdot l_1} + \frac{mg \cdot \sin \theta \cdot h_1}{2 \cdot l_1}$ $P_{1T} = \frac{mg \cdot \sin \theta}{4} + \frac{mg \cdot \sin \theta \cdot l_2}{2 \cdot l_0}$ $P_2 = \frac{mg \cdot \cos \theta}{4} - \frac{mg \cdot \cos \theta \cdot l_2}{2 \cdot l_0} - \frac{mg \cdot \cos \theta \cdot l_3}{2 \cdot l_1} + \frac{mg \cdot \sin \theta \cdot h_1}{2 \cdot l_1}$ $P_{2T} = \frac{mg \cdot \sin \theta}{4} - \frac{mg \cdot \sin \theta \cdot l_2}{2 \cdot l_0}$ $P_3 = \frac{mg \cdot \cos \theta}{4} - \frac{mg \cdot \cos \theta \cdot l_2}{2 \cdot l_0} + \frac{mg \cdot \cos \theta \cdot l_3}{2 \cdot l_1} - \frac{mg \cdot \sin \theta \cdot h_1}{2 \cdot l_1}$ $P_{3T} = \frac{mg \cdot \sin \theta}{4} + \frac{mg \cdot \sin \theta \cdot l_2}{2 \cdot l_0}$ $P_4 = \frac{mg \cdot \cos \theta}{4} + \frac{mg \cdot \cos \theta \cdot l_2}{2 \cdot l_0} + \frac{mg \cdot \cos \theta \cdot l_3}{2 \cdot l_1} - \frac{mg \cdot \sin \theta \cdot h_1}{2 \cdot l_1}$ $P_{4T} = \frac{mg \cdot \sin \theta}{4} + \frac{mg \cdot \sin \theta \cdot l_2}{2 \cdot l_0}$
9	<p>Block move Moment load in case of application to side slope / cutting load</p> 	$P_1 = \frac{mg \cdot \cos \theta}{4} + \frac{mg \cdot \cos \theta \cdot l_2}{2 \cdot l_0} - \frac{mg \cdot \cos \theta \cdot l_3}{2 \cdot l_1} + \frac{mg \cdot \sin \theta \cdot h_1}{2 \cdot l_0}$ $P_{1T} = \frac{mg \cdot \sin \theta \cdot l_3}{2 \cdot l_0}$ $P_2 = \frac{mg \cdot \cos \theta}{4} - \frac{mg \cdot \cos \theta \cdot l_2}{2 \cdot l_0} - \frac{mg \cdot \cos \theta \cdot l_3}{2 \cdot l_1} - \frac{mg \cdot \sin \theta \cdot h_1}{2 \cdot l_0}$ $P_{2T} = -\frac{mg \cdot \sin \theta \cdot l_3}{2 \cdot l_0}$ $P_3 = \frac{mg \cdot \cos \theta}{4} - \frac{mg \cdot \cos \theta \cdot l_2}{2 \cdot l_0} + \frac{mg \cdot \cos \theta \cdot l_3}{2 \cdot l_1} - \frac{mg \cdot \sin \theta \cdot h_1}{2 \cdot l_0}$ $P_{3T} = -\frac{mg \cdot \sin \theta \cdot l_3}{2 \cdot l_0}$ $P_4 = \frac{mg \cdot \cos \theta}{4} + \frac{mg \cdot \cos \theta \cdot l_2}{2 \cdot l_0} + \frac{mg \cdot \cos \theta \cdot l_3}{2 \cdot l_1} + \frac{mg \cdot \sin \theta \cdot h_1}{2 \cdot l_0}$ $P_{4T} = \frac{mg \cdot \sin \theta \cdot l_3}{2 \cdot l_0}$

E.g.) CNC lathe, Tool rest

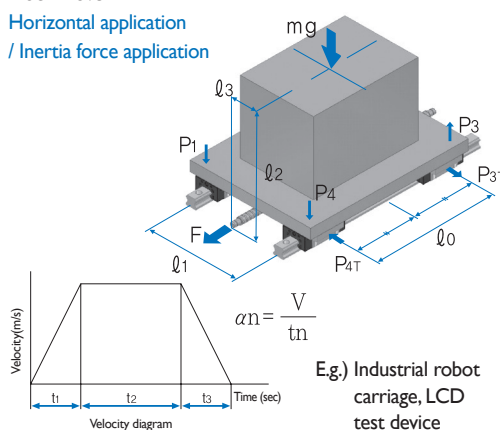
Case	Service Conditions	Load Calculation Formula
10	<p>Block move Horizontal application / Inertia force application</p>  <p>E.g.) Industrial robot carriage, LCD test device</p>	<p><b>Acceleration</b></p> $P_1=P_4 = \frac{mg}{4} - \frac{m \cdot \alpha \cdot l_2}{2 \cdot l_0}$ $P_2=P_3 = \frac{mg}{4} + \frac{m \cdot \alpha \cdot l_2}{2 \cdot l_0}$ $P_{1T} \sim P_{4T} = \frac{m \cdot \alpha \cdot l_3}{2 \cdot l_0}$ <p><b>Constant velocity</b></p> $P_{1T} \sim P_{4T} = \frac{mg}{4}$ <p><b>Deceleration</b></p> $P_1=P_4 = \frac{mg}{4} + \frac{m \cdot \alpha \cdot l_2}{2 \cdot l_0}$ $P_2=P_3 = \frac{mg}{4} - \frac{m \cdot \alpha \cdot l_2}{2 \cdot l_0}$ $P_{1T} \sim P_{4T} = \frac{m \cdot \alpha \cdot l_3}{2 \cdot l_0}$

## 5. Equivalent load calculation

There are diverse kinds of load imposed on a block in a linear motion guide, such as compression load in vertical direction, tensile load, horizontal load, and moment load. There is also complex load of them. Sometimes the magnitude and direction of load change. Since it is difficult to calculate the variable load when calculating the life of the linear motion guide, it is required to use the equivalent load converted into the compression load or tensile load in vertical direction in order to calculate the life or static safety factor.

## 6. Equivalent load calculation formula

If a linear motion guide bears vertical compression load or tensile load or horizontal load simultaneously, or if the magnitude or direction of load changes, an equivalent load is calculated in the following formula.

$$P_E(\text{Equivalent load}) = P_n + P_{nT}$$

$P_n$  : Compression load

$P_{nT}$  : Horizontal load

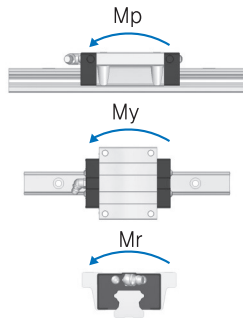
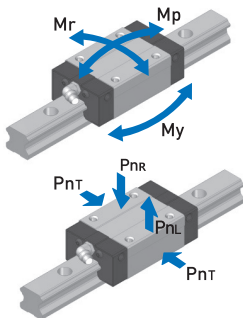

$P_n$  : Compression load

$P_L$  : Tensile load

$P_{nT}$  : Horizontal load

$M_p$  : Pitching moment

$M_y$  : Yawing moment

$M_r$  : Rolling moment

Figure 2.



## 7. Static safety factor calculation

Any unexpected big load may be applied to a linear motion guide due to the inertia force caused by vibration impact or quick braking and moment load of mechanical structure. To select a linear motion guide, it is required to take into account static safety factor and prepare for such load. Static safety factor ( $f_s$ ) is the value obtained by dividing basic static load rating by the calculated load. To see the baseline of static safety factor by service condition, please see Table I-1 and Table I-2.

Table I-1. Baseline of static safety factor( $f_s$ )

Type of rolling element	Service condition	Static safety factor ( $f_s$ )
Ball	There are no vibration and impacts.	1.0 ~ 1.5
	High driving performance is needed.	1.5 ~ 2.0
	There are moment load, violation, and impacts.	2.5 ~ 7.0
Roller	There are no vibration and impacts.	2.0 ~ 3.0
	High driving performance is needed.	3.0 ~ 5.0
	There are moment load, violation, and impacts.	4.0 ~ 7.0

Table I-2.

If compression load is big	$\frac{f_H \cdot f_T \cdot f_C \cdot C_0}{P_n} \geq f_s$
If tensile load is big	$\frac{f_H \cdot f_T \cdot f_C \cdot C_{0L}}{P_L} \geq f_s$
If horizontal load is big	$\frac{f_H \cdot f_T \cdot f_C \cdot C_{0T}}{P_{nT}} \geq f_s$

$f_s$  : Static safety factor

$C_0$  : Basic static load rating(vertical) (N)

$C_{0L}$  : Basic static load rating (reverse-vertical) (N)

$C_{0T}$  : Basic static load rating (horizontal) (N)

$P_n$  : Calculated load (vertical) (N)

$P_L$  : Calculated load (reverse-vertical) (N)

$P_{nT}$  : Calculated load (horizontal) (N)

$f_H$  : Hardness factor

$f_T$  : Temperature factor

$f_C$  : Contact factor

## 8. Mean load calculation

The load applied to a block of a linear motion guide is not constant but differs according to service conditions. Therefore, the load that becomes equal to life under the condition of variable load is used. This is called mean load. If the load applied to the block is changed due to an external condition, it is required to calculate a life with the mean load in consideration of the various conditions shown below. If load applied to block varies in different conditions, it is necessary to a life in consideration of the condition of variable load. Mean load ( $P_m$ ) refers to constant load that becomes equal to the life under the conditions of variable load when the load applied to a block changes in various conditions while the device is driving.

$$P_m = \sqrt[i]{\frac{1}{L} \cdot \sum_{n=1}^n (P_n^i \cdot L_n)}$$

- $P_m$  : Mean load (N)
- $P_n$  : Variable load (N)
- $L$  : Total travel distance (mm)
- $L_n$  : Travel distance by loading  $P_n$  (mm)
- $i$  : Ball - 3, Roller - 10/3

Note) the formula above or formula (1) below is applied to a ball type only.

### 1) Change in phase

$$P_m = \sqrt[i]{\frac{1}{L} (P_1^i \cdot L_1 + P_2^i \cdot L_2 + \dots + P_n^i \cdot L_n)} \dots (1)$$

- $P_m$  : Mean load (N)
- $P_n$  : Variable load (N)
- $L$  : Total travel distance (mm)
- $L_n$  : Travel distance by loading  $P_n$  (mm)

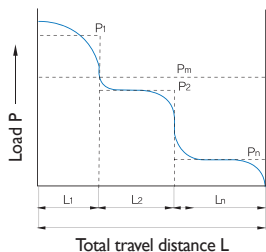

### 2) Change monotonously

$$P_m \approx \frac{1}{3} (P_{min} + 2 \cdot P_{max}) \dots (2)$$

- $P_{min}$  : Minimum load (N)
- $P_{max}$  : Maximum load (N)

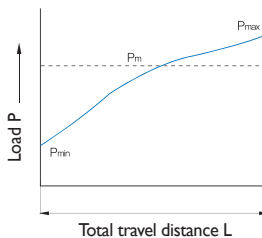

### 3) Change in a sine curve

$$a) P_m \approx 0,65 P_{max} \dots (3)$$

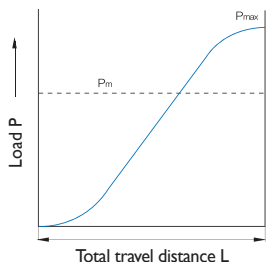

$$b) P_m \approx 0,75 P_{max} \dots (4)$$

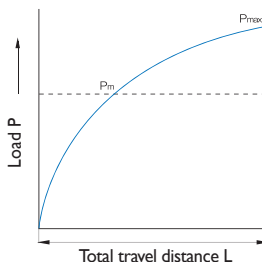

## 9. Rating life calculation

A rating life needs to be calculated because life of a linear motion guide differs even under the same driving conditions. Rating life of a linear motion guide is a total travel distance that a linear motion guide system composed of a certain number of units can drive without flaking in 90% of the race way surface or rolling element after being run under the same working conditions. If a ball or a roller is used as a rolling element, it is possible to calculate a rating life in the following formula.

The formula to calculate the rating life of a ball-enabled linear motion guide

$$L = \left( \frac{f_H \cdot f_T \cdot f_C}{f_w} \cdot \frac{C}{P_C} \right)^3 \times 50$$

L	: Rating life	(km)
C	: Basic dynamic load rating	(N)
P <sub>C</sub>	: Calculated load	(N)
f <sub>H</sub>	: Hardness factor	See Figure 3
f <sub>T</sub>	: Temperature factor	See Figure 4
f <sub>C</sub>	: Contact factor	See Table 2
f <sub>w</sub>	: Load factor	See Table 3

The formula to calculate the rating life of a roller-enabled linear motion guide

$$L = \left( \frac{f_H \cdot f_T \cdot f_C}{f_w} \cdot \frac{C}{P_C} \right)^{\frac{10}{3}} \times 100$$

L	: Rating life	(km)
C	: Basic dynamic load rating	(N)
P <sub>C</sub>	: Calculated load	(N)
f <sub>H</sub>	: Hardness factor	See Figure 3
f <sub>T</sub>	: Temperature factor	See Figure 4
f <sub>C</sub>	: Contact factor	See Table 2
f <sub>w</sub>	: Load factor	See Table 3

If the length of stroke and the number of reciprocating motions are constant, it is possible to calculate a life time with the use of the rating life (L) in the following formula:

$$L_h = \frac{L \times 10^6}{2 \times l_s \times n_1 \times 60}$$

L <sub>h</sub>	: Life time	(N)
l <sub>s</sub>	: Length of stroke	(mm)
n <sub>1</sub>	: No. of reciprocating motions	(min <sup>-1</sup> )

### 1) Hardness factor ( $f_H$ )

To implement the best performance of a linear motion guide, it is necessary to maintain appropriately the hardness and depth of the raceway surface of the block and rail that contact a rolling element (ball or roller).

WON linear motion guide has HRC58-64 surface hardness. There is no need to consider hardness factor. If the hardness is lower than a baseline, load capacity of a linear motion guide decreases. In this case, it is necessary to apply hardness factor to life calculation.

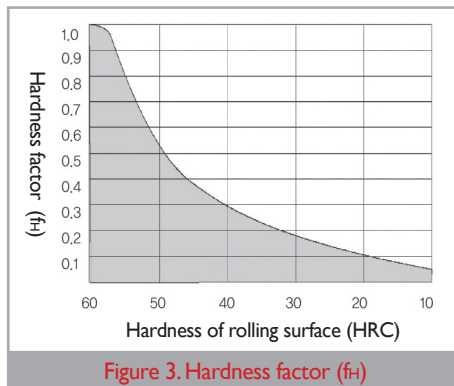

Figure 3. Hardness factor ( $f_H$ )

### 2) Temperature factor ( $f_T$ )

If high temperature over 100°C is applied to a linear motion guide, it is necessary to take into account temperature factor ( $f_T$ ) at the time when a linear motion guide is selected.

Please make sure to use WON linear motion guide at below 80°C. At over 80°C, please use a high-temp linear motion guide.

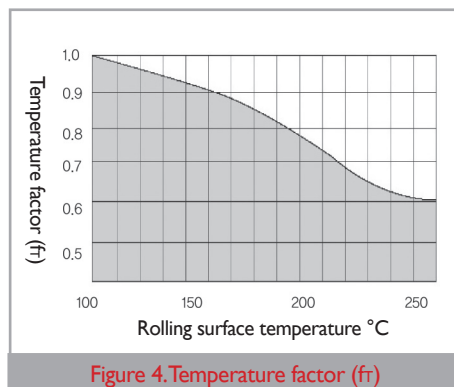

Figure 4. Temperature factor ( $f_T$ )

Note) If ambient temperature is over 80°C, it is necessary to use the materials of seal, end plate, and support plate that have specifications for high temperature.

### 3) Contact factor ( $f_c$ )

If over two blocks are closely assembled and mounted, uniform load may not be applied to the blocks due to difference among mounting surfaces. Therefore, it is required to multiply basic static load rating (C) and basic dynamic load rating (C<sub>0</sub>) by the contact factor shown in Table 2.

Table 2.

N° of blocks in close contact	Contact Factor ( $f_c$ )
2	0,81
3	0,72
4	0,66
5	0,61
Over 6	0,6
Common use	1,0

#### 4) Load factor ( $f_w$ )

Generally the static load applied to the block of a linear motion guide can be calculated in formula. However, while a machine is running, the load applied to the block tends to come from vibration or impacts. Therefore, as for the vibration or impact load at high-speed running, it is necessary to consider the load factor ( $f_w$ ) shown in Table 3. Divide the basic dynamic load rating of a linear motion guide by a load factor ( $f_w$ ).

Table 3

External condition	Service Conditions	Load factor
Low	Smooth running at mild speed; no external vibration or impacts	1.0 ~ 1.3
Moderate	Low speed; moderate external vibration or impacts	1.2 ~ 1.5
High	High speed; strong vibration or impacts	1.5 ~ 2.0
Very high	Very high speed; strong vibration and impacts at running	2.0 ~ 4.0

## 4 Rigidity and Preload

### I. Preload

A linear motion guide is preloaded in a way that it improves mechanical precision by eliminating clearance using the rolling element (ball or roller) inserted into the space between a rail and a block or in a way that it applies load to the rolling element in advance by inserting the rolling element larger than the clearance of the raceway between a rail and a block. This process will enhance the rigidity of the linear motion guide and will lessen the displacement level caused by external load.

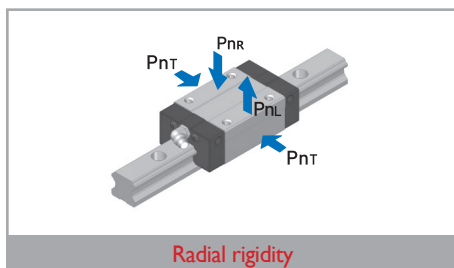
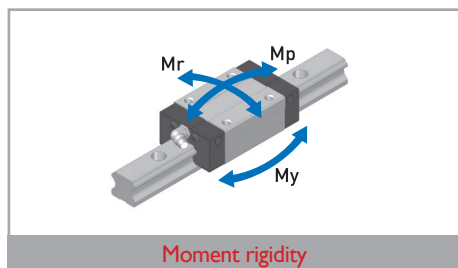
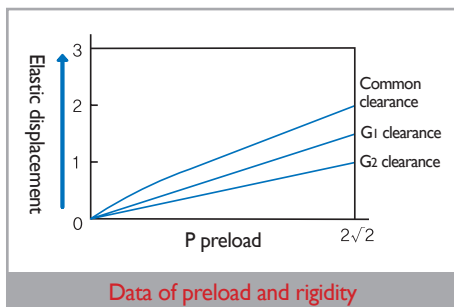
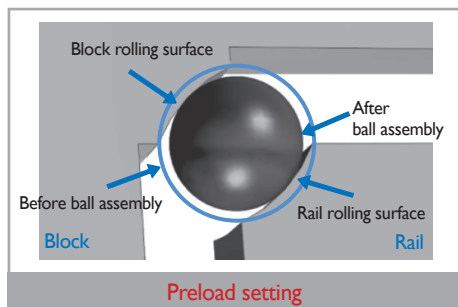

## 2. Radial clearance

Radial clearance refers to a total travel distance in a radial direction from the center of a block of a linear motion guide when mild load is applied to the block up and down from the center part of the rail which is then fixed to base. Radial clearance is usually classified into common clearance (no symbol), G1 clearance (light preload), G2 clearance (heavy load), and Gs clearance (special preload), which is selectable depending on usage. The values are standardized by form.

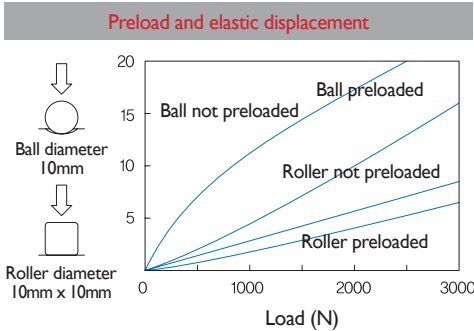

Type	Preload symbol	preload	
H	Moderate	No symbol	$0 \sim 0.03 \times C$
	Light	G1	$0.04 \sim 0.08 \times C$
	Heavy	G2	$0.09 \sim 0.13 \times C$
S	Moderate	No symbol	$0 \sim 0.03 \times C$
	Light	G1	$0.03 \sim 0.05 \times C$
	Heavy	G2	$0.06 \sim 0.08 \times C$
R	Light	G1	Equivalent to 0.03C
	Heavy	G2	Equivalent to 0.08C
	Special	G3	Equivalent to 0.13C

Table 4. Service conditions for radial clearance (preload)

Type	Preload status	Symbol	Service conditions	Use
1. Moderate	Plus-minus clearance	No symbol (1)	<ul style="list-style-type: none"> <li>Load is applied in uniform direction and smooth running is needed</li> <li>There is almost no vibration or impact and precise running is required.</li> </ul>	Welding machine, textile machinery, packaging machinery, various conveyors, medical equipment, woodworking machine, glass cutting machine, take-out robots, ATC, winding machine
2. Light	A small amount of minus clearance	G1 (2)	<ul style="list-style-type: none"> <li>There is a little vibration or impact, and moment load</li> <li>Light load is applied, yet high precision is required</li> </ul>	Various industrial robots, measuring equipment, inspection equipment, 3D processor, laser processor, PCB drilling machine, various assembling machines, electric spark machine, punching press
3. Heavy	A large amount of minus clearance	G2 (3)	<ul style="list-style-type: none"> <li>There are mild impact load, overhang load and moment load. Rigidity and high precision are required.</li> </ul>	CNC lathe, machining center, milling machine, grinding machine, tapping center, drilling machine, hobbing machine, a variety of special equipment
4. Special	A small or large amount of minus clearance	Gs (4)	<ul style="list-style-type: none"> <li>Smaller clearance than that of G1 preload; light and precise operation is required.</li> <li>Larger preload than that of G2; impact load and complex load; high strength and high rigidity are needed.</li> </ul>	No preload, ultra-light preload, larger-than-moderate preload, special preload customized to user conditions, special processing machine for heavy-duty cutting

Note (1) No clearance or very small clearance.

(2) Very small minus clearance

(3) Quiet large minus clearance to enhance rigidity

(4) Preload below G1 or over G2 to meet service conditions

Table 5. Radial clearance of H, S & HS Series

Unit :  $\mu\text{m}$

Model No.			Symbol		
			Moderate	Light preload	Heavy preload
			No symbol	G1	G2
H15	S15	-	-4 ~ +2	-12 ~ -4	-
H20	S20	-	-5 ~ +2	-14 ~ -5	-23 ~ -14
H25	S25	HS25	-6 ~ +3	-16 ~ -6	-26 ~ -16
H30	-	HS30	-7 ~ +4	-19 ~ -7	-31 ~ -19
H35	-	HS35	-8 ~ +4	-22 ~ -8	-35 ~ -22
H45	-	-	-10 ~ +5	-25 ~ -10	-40 ~ -25
H55	-	-	-12 ~ +5	-29 ~ -12	-46 ~ -29

Table 6. Radial clearance of HW Series

Unit :  $\mu\text{m}$

Model No.		Symbol		
		Moderate	Light preload	Heavy preload
		No symbol	G1	G2
HB17		-3 ~ 0	-7 ~ -3	-
HB21		-4 ~ +2	-8 ~ -4	-
HB27		-5 ~ +2	-11 ~ -5	-
HB35		-8 ~ +4	-18 ~ -8	-28 ~ -18

Table 7. Radial clearance of M & MB Series

Unit :  $\mu\text{m}$

Model No.		Symbol	
		Moderate	Light preload
		No symbol	G1
M5	MB5	0 ~ +1.5	-1 ~ 0
M7	MB7	-2 ~ +2	-3 ~ 0
M9	MB9	-2 ~ +2	-4 ~ 0
M12	MB12	-3 ~ +3	-6 ~ 0
M15	MBT13,MB15	-5 ~ +5	-10 ~ 0
M20	-	-7 ~ +7	-14 ~ 0

Table 8. Radial clearance of R Series

Unit :  $\mu\text{m}$

Model No.	Symbol			Model No.	Symbol		
	Light preload	Heavy preload	Special preload		Light preload	Heavy preload	Special preload
	G1	G2	G3		G1	G2	G3
R25	-2 ~ -1	-3 ~ -2	-4 ~ -3	R45	-2 ~ -1	-3 ~ -2	-5 ~ -3
R30	-2 ~ -1	-3 ~ -2	-4 ~ -3	R55	-2 ~ -1	-4 ~ -2	-6 ~ -4
R35	-2 ~ -1	-3 ~ -2	-5 ~ -3	R65	-3 ~ -1	-5 ~ -3	-8 ~ -5

## 5 Friction

### 1. Friction

Friction of a linear motion guide resistance is about 1/20-1/40 of an existing sliding guide because a rolling element (ball or roller) is assembled in between a rail and a block which is the raceway surface. In addition, the device has low starting torque because the difference between static friction and kinetic friction is very small. low power loss and temperature rise in the part of linear motion are of advantage to speedy operation. high conformability and response make it possible to do high-precise positioning.

### 2. Friction coefficient

Friction of a linear motion guide resistance relies on the load applied to the linear motion guide, speed, lubrication or form. In the case of light load or speedy motion, lubricant or seal is the main cause of friction resistance. In the case of heavy load or slow motion, the magnitude of load affects friction resistance.

$$F = \mu P$$

F : Friction resistance (N)

$\mu$  : Kinetic friction factor

P : Load (N)

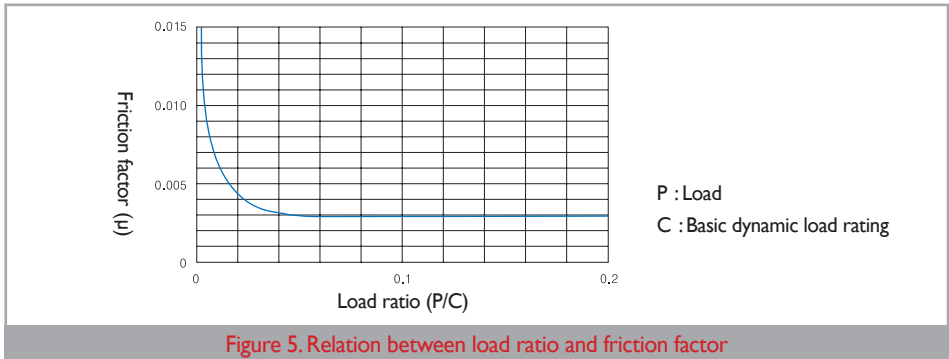

Common friction coefficients of various operating systems are shown below in the table, and are applied if there are appropriate lubricant or assembly and normal load.

Type of operating system	Major model number	Friction factor $\mu$
Linear Motion Guide	H, H...S, HB, S, S...S, HS, HS...S, M, MB	0.002 ~ 0.003
	R, RS	0.001 ~ 0.002
Ball Spline	WLS, WSP	0.002 ~ 0.003
Super Ball Bushing / Linear Ball Bushing	SB, SBE, LM, LME	0.001 ~ 0.003
Cross Roller Guideway	WRG	0.001 ~ 0.0025



## 6 Precision

### 1. Precision specification

How to measure degree of a linear motion guide of travel is as follows (See Figure 6).

- Tighten the rail to the mounting surface of the bed with a bolt at the defined torque.
- Draw a measuring jig right up against the datum plane of the block as shown in the figure.
- Make a measurement by making the block and measuring jig travelled in the entire section from the starting point to the end point of the rail.
- The value measured in the above way is an error of parallelism of motion that the block has on the basis of the rail.

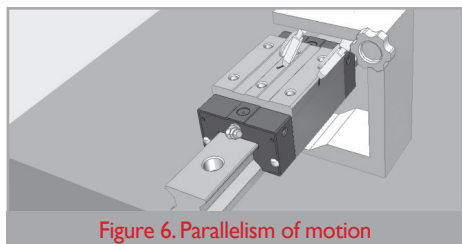

Figure 6. Parallelism of motion

The degree of parallelization between the datum plane of the block and that of rail

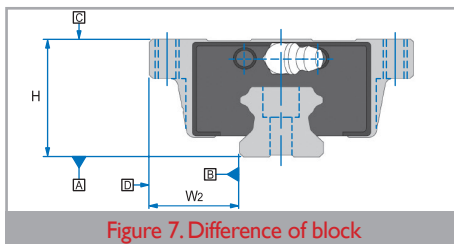

Figure 7. Difference of block

Difference between the blocks installed in the plane

### 2. Precision design

Table 9. Dimensional tolerance and parallelism of motion

Dimension	Description
Dimensional tolerance of height H	Distance from the base side of rail A to the top side of block C
Difference in height H	Difference in the height of blocks combined from each rail on the same plane
Dimensional tolerance of width W <sub>2</sub>	Distance between the datum plane of rail B and the reference side of block D
Difference in width W <sub>2</sub>	Difference between the reference side of rail B of the block combined to the rail, and the reference side of block D
Parallelism of motion of C against A	Change in the top side of block C based on the base side of rail A during the motion of the block combined to the rail
Parallelism of motion of D against B	Change in the reference side of block D based on the reference side of rail B during the motion of block combined to the rail

### 3. Dimension tolerance and difference

Table 10. Precision specification of linear motion guide (H, H...S, HV, S, S...S, HS, HS...S series)

Unit : mm

Dimension	Moderate No symbol	High H P6	Precision P P5	Super precision SP P4	Ultra precision UP P3
Dimensional tolerance of height H	±0.080	±0.042	±0.020	±0.010	±0.008
Difference in height H	0.025	0.015	0.007	0.005	0.003
Dimensional tolerance of width W <sub>2</sub>	±0.100	±0.050	±0.025	±0.015	±0.010
Difference in width W <sub>2</sub>	0.030	0.020	0.010	0.007	0.003
Parallelism of motion of C against A	See Table 11.				
Parallelism of motion of D against B	See Table 11.				

Table 11. Length of rail and parallelism of motion of linear motion guide (H, H...S, HB, S, S...S, HS, HS...S Series)

 Unit :  $\mu\text{m}$ 

Length of rail		Parallelism of motion				
Excess	Below	Moderate No symbol	High P6	Precision P5	Super precision P5	Ultra precision P3
-	50	5	3	2	1.5	1
50	80	5	3	2	1.5	1
80	125	5	3	2	1.5	1
125	200	5	3.5	2	1.5	1
200	250	6	4	2.5	1.5	1
250	315	7	4.5	3	1.5	1
315	400	8	5	3.5	2	1.5
400	500	9	6	4.5	2.5	1.5
500	630	11	7	5	3	2
630	800	12	8.5	6	3.5	2
800	1000	13	9	6.5	4	2.5
1000	1250	15	11	7.5	4.5	3
1250	1600	16	12	8	5	4
1600	2000	18	13	8.5	5.5	4.5
2000	2500	20	14	9.5	6	5
2500	3150	21	16	11	6.5	5.5
3150	4000	23	17	12	7.5	6

Table 12. Precision specification of miniature linear motion guide (M, MB Series)

Unit : mm

Model No.	Dimension	Precision spec	Moderate	High	Precision
			No symbol	P6	P5
5	Dimensional tolerance of height H		$\pm 0.030$	-	$\pm 0.015$
	Difference in height H		0.015	-	0.005
	Dimensional tolerance of width W <sub>2</sub>		$\pm 0.030$	-	$\pm 0.015$
	Difference in width W <sub>2</sub>		0.015	-	0.005
	Parallelism of motion of C against A		See Table 13.		
	Parallelism of motion of D against B		See Table 13.		
7	Dimensional tolerance of height H		$\pm 0.040$	$\pm 0.020$	$\pm 0.010$
9	Difference in height H		0.030	0.015	0.007
12	Dimensional tolerance of width W <sub>2</sub>		$\pm 0.040$	$\pm 0.025$	$\pm 0.015$
13	Difference in width W <sub>2</sub>		0.030	0.020	0.010
15	Parallelism of motion of C against A		See Table 13.		
20	Parallelism of motion of D against B		See Table 13.		

Table 13. Length of rail and parallelism of motion of miniature linear motion guide (M, MB series) Unit :  $\mu\text{m}$

Length of rail		Parallelism of motion		
Above	Below	Moderate	High	Precision
		No symbol	H P6	P P5
-	40	8	4	1
40	70	10	4	1
70	100	11	4	2
100	130	12	5	2
130	160	13	6	2
160	190	14	7	2
190	220	15	7	3
220	250	16	8	3
250	280	17	8	3
280	310	17	9	3
310	340	18	9	3
340	370	18	10	3
370	400	19	10	3
400	430	20	11	4
430	460	20	12	4
460	490	21	12	4
490	520	21	12	4
520	550	22	12	4
550	580	22	13	4
580	610	22	13	4
610	640	22	13	4
640	670	23	13	4
670	700	23	13	5
700	730	23	14	5
730	760	23	14	5
760	790	23	14	5
790	820	23	14	5

Length of rail		Parallelism of motion		
Above	Below	Moderate	High	Precision
		No symbol	H P6	P P5
820	850	24	14	5
850	880	24	14	5
880	910	24	14	5
910	940	24	14	5
940	970	24	14	5
970	1000	25	14	5
1000	1030	25	16	5
1030	1060	25	16	5
1060	1090	25	16	6
1090	1120	25	16	6
1120	1150	25	16	6
1150	1180	25	17	6
1180	1210	26	17	6
1210	1240	26	17	6
1240	1270	26	17	6
1270	1300	26	17	6
1300	1330	26	17	6
1330	1360	27	17	6
1360	1390	27	18	6
1390	1420	27	18	6
1420	1450	27	18	7
1450	1480	27	18	7
1480	1510	27	18	7
1510	1540	28	19	7
1540	1570	28	19	7
1570	1800	28	19	7

Table 14. Specifications for precision of linear motion guide (R series)

 Unit :  $\mu\text{m}$ 

Dimension	High	Precision	Super precision	Ultra precision
	H	P	SP	UP
	P6	P5	P4	P3
Dimensional tolerance of height H	$\pm 0.042$	$\pm 0.020$	$\pm 0.010$	$\pm 0.008$
Difference in height H	0.015	0.007	0.005	0.003
Dimensional tolerance of width W <sub>2</sub>	$\pm 0.050$	$\pm 0.025$	$\pm 0.015$	$\pm 0.010$
Difference in width W <sub>2</sub>	0.020	0.010	0.007	0.003
Parallelism of motion of C against A	See Table 15.			
Parallelism of motion of D against B	See Table 15.			

Table 15. Length of rail and parallelism of motion of linear motion guide (R series)

 Unit :  $\mu\text{m}$ 

Length of rail		Parallelism of motion			
Above	Below	High	Precision	Super Precision	Ultra Precision
		P6	P5	P4	P3
-	50	3	2	1.5	1
50	80	3	2	1.5	1
80	125	3	2	1.5	1
125	200	3.5	2	1.5	1
200	250	4	2,5	1.5	1
250	315	4.5	3	1.5	1
315	400	5	3.5	2	1.5
400	500	6	3.5	2	1.5
500	630	7	5	3	2
630	800	8.5	6	3.5	2
800	1000	9	6.5	4	2.5
1000	1250	11	7.5	4.5	3
1250	1600	12	8	5	4
1600	2000	13	8.5	5.5	4.5
2000	2500	14	9.5	6	5
2500	3150	16	11	6.5	5.5
3150	4000	17	12	7.5	6

## 4. Selection of precision class

Table 16. For the selection of precision class of linear motion guide by unit, please refer to the table shown below.

Application	Unit	Precision class					Preload		
		Preload type	High	Precision	Super precision	Ultra precision	Preload type	Light preload	Heavy preload
		No symbol	H P6	P P5	SP P4	UP P3	No symbol	G1	G2
Machine Tool	CNC Lathe		●	●	●				●
	Machining center		●	●	●				●
	NC milling machine			●	●				●
	CNC tapping machine		●	●	●				●
	NC boring machine		●	●	●				●
	NC drilling machine		●	●	●				●
	3D engraving machine		●	●	●				●
	Jig boring machine		●	●	●				●
	EDM electric spark machine			●	●	●		●	●
	Grinding machine			●	●	●			●
Semiconductor equipment	Prober equipment					●		●	●
	Wire bonder				●	●		●	●
	Slicing machine				●	●		●	
	Dicing machine				●	●		●	
	IC test handler			●	●			●	
	PCB laser via-hole driller				●			●	
	PCB inspection equipment			●	●			●	
	Laser marker			●				●	
FPD	Chip mounter			●	●			●	
	Mac/Mic inspection equipment				●	●		●	
	Phantom inspection equipment				●	●		●	
	Exposure				●	●		●	
	Laser repair			●	●	●		●	
	Lighting inspection equipment		●	●				●	
	Coater machine			●	●			●	
	Chip bonding machine		●	●				●	
	Dispenser machine		●	●				●	

Application	Unit	Precision class					Preload		
		Preload type	High	Precision	Super precision	Ultra precision	Preload type	Light preload	Heavy preload
		No symbol	H P6	P P5	SP P4	UP P3	No symbol	G1	G2
FPD	Scriber		•	•				•	
	Glass edge grinding machine		•	•				•	
	FPD measuring test equipment			•	•			•	
	Laminating equipment		•	•				•	
	Indentation test equipment								
	Prober equipment								
Industrial machine	Punching press		•					•	
	Tire molder	•						•	
	Tire vulcanizer	•						•	
	Auto-shearing machine	•						•	
	Auto-welding machine	•					•	•	
	Conveyor	•					•		
	Textile machine	•					•		
	Injection molding machine	•					•	•	
Industrial robot	Cartesian coordinated robot	•	•	•				•	
	Gantry robot	•	•					•	
	LTR robot		•	•				•	
	Take-out robot	•						•	
	Cylindrical coordinated robot		•					•	
	Vacuum robot		•	•				•	
	Robot carriage	•							
	Linear actuator		•	•	•		•	•	
Others	Office machine	•					•		
	FA transport equipment	•					•		
	Medical equipment	•					•	•	
	Welding machine	•					•		
	Painting machine	•					•		
	Precision XY table		•	•	•			•	
	UVW stage		•	•				•	
3D measuring machine			•	•	•		•		

## 7 Lubrication

### 1. Purpose

The purpose of lubricating a linear motion guide is to create an oil surface between the raceway surface of rail and block and a rolling element so as to avoid the direct contact of metals, and thereby to reduce friction, wear and heat, preventing the raceway surface and the rolling element from being overheated and melted to be adhered to each other. Moreover, the oil surface created between the raceway surface and a ball decreases load-induced contact stress, so that it can improve the rolling contact fatigue life and prevent rust. A linear motion guide is equipped with a seal. Nevertheless, grease inside the block oozes while the device is in operation. For this reason, it is required to supply a lubricant at a time and interval appropriate to each service condition.

### 2. Selection of lubricant

To achieve the best performance of a linear motion guide, it is necessary to select the lubricant suitable for service conditions. Lubricants used for a linear motion guide include grease and oil. It is possible to select an appropriate lubricant and lubrication method depending on service conditions, load, operating speed, assembly type, etc.

### 3. Grease lubrication

Grease is a semisolid lubricant that consists base oil, thickener, and additives.

Generally, when a linear motion guide is lubricated with grease, lithium soap grease is used. In the condition of high load or the condition of use, the grease mixed with extreme-pressure additive is used. To apply a linear motion guide to a high-vacuum environment or a cleanroom, it is desirable to select a type of grease excellent at low evaporation and low dust generation.

#### 1) Grease refilling

For grease refilling in a linear motion guide, it is necessary to supply a sufficient amount of grease with the use of a grease nipple until remaining grease is discharged. It is appropriate to fill up 50% or so volume block with grease. After refilling, rolling resistance can be increased. In order to reduce the rolling resistance, it is better to take a test run about 20 times prior to the operation.

#### 2) Refill interval

If a travel of linear motion guide exceeds a certain time, its lubricating performance declines. So it is required to supply an appropriate amount of grease at a proper time depending on service conditions and environment. Usually, it is necessary to supply grease when travel of the device distance reaches 100km.

$$T = \frac{100 \times 6000}{V_e \times 60} \text{ hr}$$

T : Oil refilling cycle (time)  
V<sub>e</sub> : Velocity (m/min)

## 4. Oil lubrication

When a linear motion guide is lubricated with oil, it is recommended to use an oil lubricant with high viscosity ( $68\text{mm}^2/\text{sec}$ ) under the condition of high load, and an oil lubricant with low-viscosity ( $13\text{mm}^2/\text{sec}$ ) under the condition of high velocity. As for oil lubrication, the recommended oil supply amount per block is  $0.3\text{cm}^3$  per hour.

Table 17. Inspection and refilling time of lubricant

Type	Checkpoints	Inspection cycle	Refilling time
Grease	<ul style="list-style-type: none"> <li>•Check if there is any cutting chip, dust, foreign substance</li> <li>•Check if there is any contamination by other substances</li> </ul>	3-6 months	<ul style="list-style-type: none"> <li>•Generally, supply grease 1-2 times every year.</li> <li>•Usually, supply grease more than once every year if travel exceeds 100km/year.</li> <li>•Refill depending on a situation after checking the status of grease.</li> </ul>
Oil	Check a lubricant quantity, contamination, and foreign substance	3-6 months	•Refill depending on the results of inspection, and determine an optimal amount depending on volume of the oil tank
	Check an oil level (Supply oil mist)	Before every operation	<ul style="list-style-type: none"> <li>•Refill appropriately after checking how much oil is consumed.</li> <li>•Define an optimal amount after how much oil is consumed</li> </ul>

Please DO NOT use any oil that affects synthetic resin, a material of linear motion guide parts.

Table 18. Lubricants used for linear motion guide

Application	Main use	Product name	Manufacturer	Manufacturer	Base oil	Type of thickener
Common use (extreme-pressure additive incl.)	Industrial machine, machine tool	BW EP NO.2	BWC	-20 ~+105	Mineral oil	Lithium
Common use	Machine tool, electric spark machine, industrial robot, etc.	GADUS S2V220 00	SHELL	-30 ~+110	Mineral oil	Lithium
Clean & low dust generation	Semiconductor, FPD equipment	SNG 5050 DEMNUM	NTG DAIKIN	-40 ~+1200 -50 ~+300	Synthetic oil	Urea
Eco-friendly	Semiconductor AMOLED process equipment, driving gear in vacuum chamber	FOMBLIN Krytox High vacuum grease	AUSIMONT DuPont Dow Corning	-20 ~+250	Synthetic oil	Re-fluoride Ethylene fluorinated
Machine tool	Excellent dust prevention and strong oil film strength Hardly emulsified to clearance, so suitable for machine tools	VACTRA NO.2 SLC DTE Oil	ExxonMobil	-20 ~+100	Oil	Way oil Turbine oil
Special use	Corrosion proofing	6459 Grease	SHELL	-20 ~+100	Mineral oil	Polyurethane



## 8 Surface Treatment

### 1. Surface treatment

WON ST uses the following methods for the optimal surface treatment of a linear motion guide in order to prevent rust and improve the quality of its appearance.

### 2. Types of surface treatment

#### 1) Electrolytic rust-preventive black coating (black Cr plating)

This is an industrial black chrome coating type that is used to improve the corrosion proof at low cost. It can achieve better corrosion proof than martensite stainless steel and be used to enhance appearance and prevent the reflection of light.

#### 2) Industrial hard chrome plating

A hardness of surface is over 850HV, so that its wear proof is excellent and its corrosion proof is comparable with that of martensite stainless steel. WON ST offers such surface treatment types such as alkaline coloring and color alumite treatment at a customer request. To use a linear motion guide after its surface treatment, it is necessary to set a high safety factor.

#### 3) Fluoride low-temperature Cr plating

It is also called "Raydent." This is a combined surface treatment type of black Cr coating with special fluoride resin coating that is used in the places requiring high corrosion proof, or in cleanroom that needs to generate low dust.

## 9 Dust Proof

### 1. Dust proof

To make use of the characteristics and performance that a linear motion guide has, it is important to protect the device against external foreign substances which are causes of abnormal wear and its shortened life span. If any dust or foreign substance is expected to be mixed in, it is required to use an effective sealing or dust-proofing system.

### 2. Types of dust proof

WON Linear Motion Guide has basically a seal assembled. If necessary, it is possible to mount a metal scraper on the device before shipment.

#### 1) Exclusive seal

In order to protect the inside of a bearing against foreign substances, an end seal and a side seal are installed on the both ends and bottom of a block, and an inner seal is mounted on the inside of the block.

#### 2) Metal scraper

A metal scraper is installed outside an end seal, so that it is effective at protecting a device against foreign substances, such as hot spatter or slag generated in a welding process.

## 10 Measures for Use in Special Environments

WON Linear Motion Guide is useful in various special applications if being used appropriately in accord with such service conditions as material, surface treatment, dust proof, and grease.

Table 19.

Application	Conditions of use	Measures	
Clean (Clean room)  -Semiconductor, FPD, medical equipment-	•If used in a clean environment, it is required to minimize dust or particles generated in a linear motion guide, as most as possible.	Lubricant	•For a clean environment •Use the grease that generates low dust
		Rust prevention	•Black Cr coating •Fluoride low-temperature colorimetric Cr plating (Raydent treatment) •Use high-corrosion resistant stainless steel as a material
Vacuum  -Semiconductor, FPD deposition equipment -	•If used in a vacuum environment that needs to maintain vacuum status, it is required to control the out gas discharged by a linear motion guide as most as possible. •Excellent rust prevention is required, since rust-prone parts cannot be used in this environment.	Lubricant	•Use the grease for a vacuum environment.
		Rust prevention (Out Gas)	•Use high-corrosion resistant stainless steel as a material •Use a self-oiling agent with special coatings like fluoroplastic coatin •Use ceramic as a material
High-temperature environment	•If used in a higher temperature environment than general one, where heat proof of a material is important, it is required to use metals for plastic synthetic resin parts	Lubricant	•Use the grease for high-temperature.
		Material	•Use an end seal, side seal+ double seal. •Use a double seal. •Use a special seal for high temperature
Dust	•If used in an environment where there are a lot of cutting chips, wood dust, and dust, it is required to take dust proof measures to protect the block against foreign substances.	Seal	•Use a plastic synthetic resin cap •Use a metal cap •Use a metal scraper
		Cap	•Use a plastic synthetic resin cap. •Use a metal cap •Use a seal plate
		Holding door	•Use an exclusive holding door •Use an sealing and all-in-one holding door
Spatter	•If exposed to a spot welding or arc welding environment, it is required to take measures to prevent hot spatters from being fixed onto a rail	Spatter	•Fluoride black Cr coating
		Seal	•Use a metal scraper
		Dust resistance	•Use a metal cap •Use a seal plate

## II Placement and Installation

### I. Placement and structure

To mount a linear motion guide on equipment, it is required to understand the overall structure of the equipment first, and then check the sizes of the base and a transfer table. To determine the optimal installation of a linear motion guide, it is necessary to take into account mounting directions such as placing vertically, in slope, or in the back, load, and the life span required.

Installation layout of linear motion guide (examples)

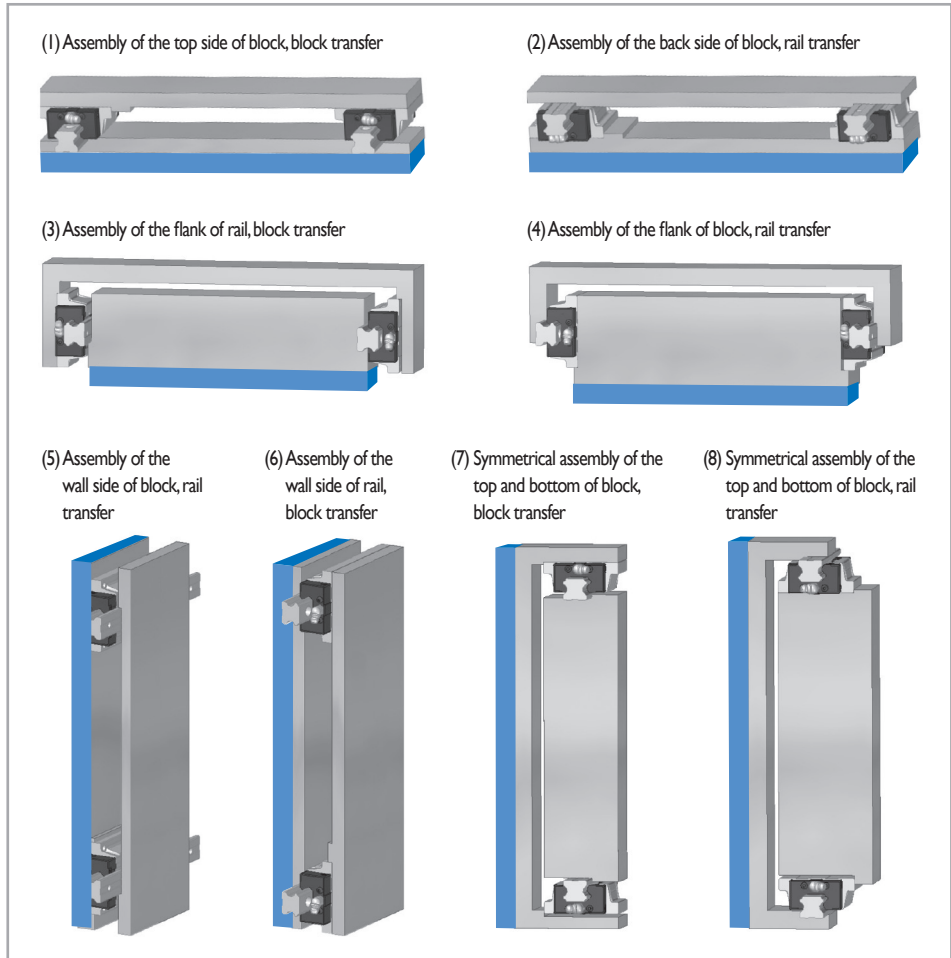

## 2. Mounting and fixation

In the structure affected by both vibration and impact, in the place that has complex load or moment load, it is required to fix a linear motion guide in a different way from a general one.

This is a widely used method. Push a pressure plate from the flank after slightly protruding a block and a rail. In this case, it is required to prevent the corners of the rail and block from being in contact with each other.

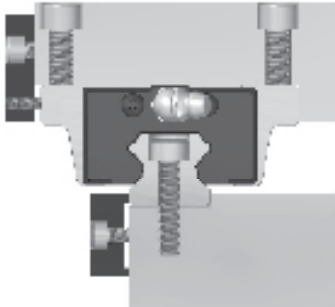

Figure 8. Pushing a pressure plate from the flank

This is a way of fastening a tapered fixture with a bolt. Even slightly bolting up generates big force in a horizontal direction. If it is bolted up too much, deformation may occur in rail, for instance, which needs to be taken a caution.

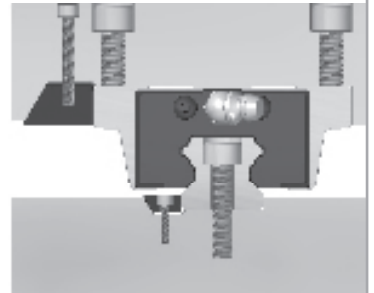

Figure 9. Pushing a tapered plate

You must be required to use miniature bolts due to the spatial constraint when a rail is pushed by a bolt. It is favorable to use as many bolts for pushing as possible.

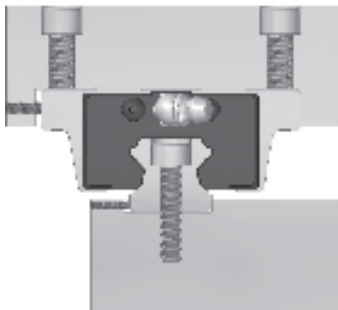

Figure 10. Pushing a bolt from the flank

This is a way of pushing a needle roller with the head of a countersunk screw. It is careful to push it to fit the screw.

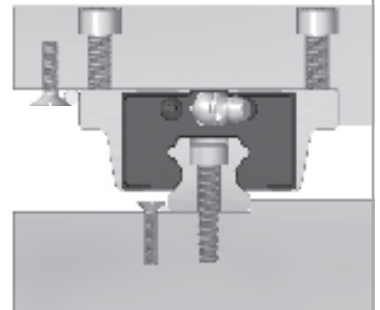

Figure 11. Pushing a roller

### 3. Design of the mounting surface for installation

#### Design and management of the mounting surface

The precision of mounting surface of a linear motion guide and an error in installation cause unexpected load and stress to the device, negatively influencing the travel and life of the device. So, it is required to take caution to prevent the harmful effects.

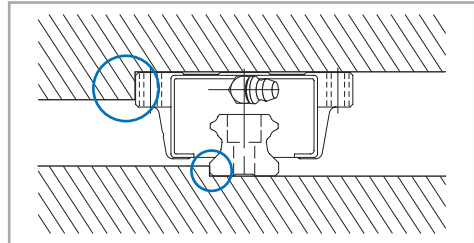

Figure 12. Shape of edges

#### Management of the vertical angle of the datum plane for installation

If the vertical angle of the installation surface of a rail or block and its datum plane is inaccurate, it might not be assembled precisely. So, it is required to review an error of vertical angle in design.

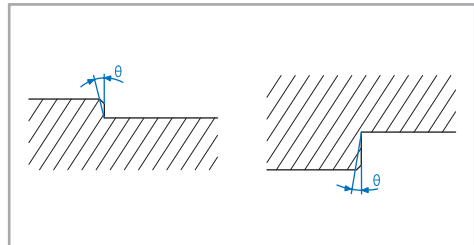

Figure 13.

#### Management of the datum plane for assembly

In designing a linear motion guide, it is important to manage the height and thickness of its assembly datum plane. If the height is too high or low, a rail or a block may fail to be assembled precisely due to its surface attachment; the application of eccentric load, horizontal load and moment load may loosen the strength of joint and cause poor assembly. In this case, precision fails to meet the requirements in design. So, attention must be paid.

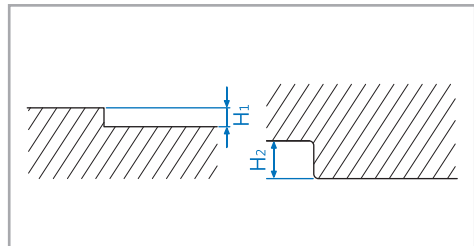

Figure 14. Vertical angle of contact datum plane

#### Management of the shape of contact corner

If the right-angled corner of a rail or block installed to the mounting surface of a linear motion guide is processed in R-shape and R value is bigger than the dimension of the surface of the rail or block, it is possible to cause a failure of precise assembly to the datum plane. So, attention must be paid.

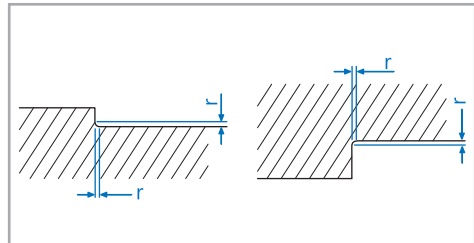

Figure 14. Vertical angle of contact datum plane

### Management of the dimensional tolerance between datum plane and bolt in design

If the dimensional tolerance between the contact datum plane of a rail or block of a linear motion guide and a mounting hole is too big, precise assembly fails. So, attention must be paid. Generally the dimensional tolerance is  $\pm 0.1\text{mm}$  as a reference value. If the distance tolerance between the assembly datum plane of rail or block and the assembly bolt hole is too wide or narrow, precise assembly may fail. So, it is required to set the tolerance to  $W3 \pm 0.1\text{mm}$  in design.

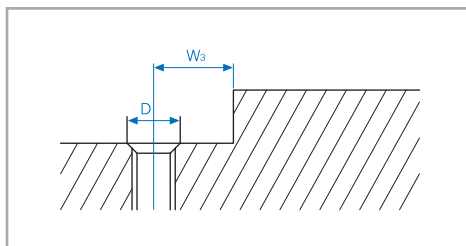

Figure 16. Dimensional tolerance between contact datum plane and mounting hole

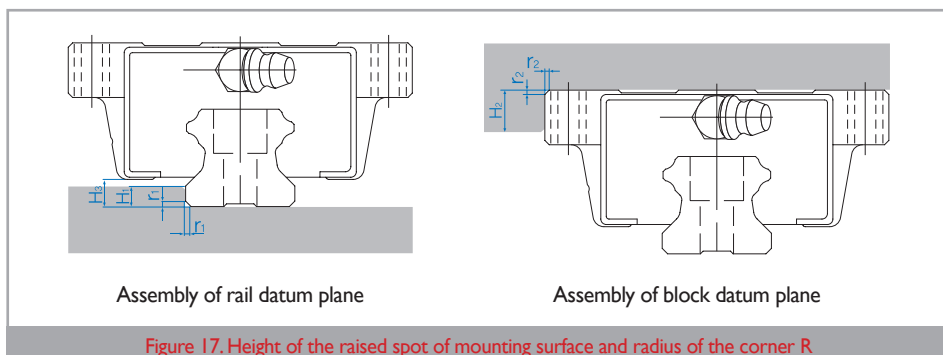

Figure 17. Height of the raised spot of mounting surface and radius of the corner R

- Make a datum plane that can contact the flank in order to secure the assembly convenience or precise position and the assembly surface of a rail or block in the installation process of a linear motion guide.
- The height of the raised spot of contact datum plane or the radius of corner depend on the specifications of a linear motion guide. So please see the table shown below.
- To prevent the raised spot from being deformed by the pressing force from above or pushing force from side, secure sufficient thickness in design.

H, H...S, HB, S, S...S, HS, HS...S Series

Unit : mm

Model No.	Radius of corner of the installation to rail $r_1(\text{max.})$	Radius of corner of the installation to block $r_2(\text{max.})$	Height of raised spot of the installation to rail	Height of raised spot of the installation to block	$H_3$
			$H_1$	$H_2$	
15	0.5	0.5	3	4	4.7
20	0.5	0.5	3.5	5	6
25	1	1	5	5	7
30	1	1	5	5	7.5
35	1	1	6	6	9
45	1	1	8	8	10
55	1.5	1.5	10	10	13

**HB Series**

Unit : mm

Model No.	Radius of corner of the installation to rail $r_1(\text{max.})$	Radius of corner of the installation to block $r_2(\text{max.})$	Height of raised spot of the installation to rail $H_1$	Height of raised spot of the installation to block $H_2$	$H_3$
17	0.4	0.4	2	4	2.5
21	0.4	0.4	2.5	5	3.3
27	0.4	0.4	2.5	5	3.5
35	0.8	0.8	3.5	5	4

**S, S...S Series**

Unit : mm

Model No.	Radius of corner of the installation to rail $r_1(\text{max.})$	Radius of corner of the installation to block $r_2(\text{max.})$	Height of raised spot of the installation to rail $H_1$	Height of raised spot of the installation to block $H_2$	$H_3$
15	0.5	0.1	2.5	4	4.5
20	0.5	1	4	5	6
25	1	1	5	5	7

**M, MB Series**

Unit: mm

Model No.	Radius of corner of the installation to rail $r_1(\text{max.})$	Radius of corner of the installation to block $r_2(\text{max.})$	Height of raised spot of the installation to rail $H_1$	Height of raised spot of the installation to block $H_2$	$H_3$
5	0.2	0.2	0.8	2	1
7	0.2	0.2	1.2	2.5	1.5
9	0.2	0.2	1.5	3	2
12	0.2	0.2	2.5	4	3
13	0.2	0.2		4.5	4
15	0.2	0.2	3	4.5	4
20	0.2	0.2	4	5	5

**R Series**

Unit : mm

Model No.	Radius of corner of the installation to rail $r_1(\text{max.})$	Radius of corner of the installation to block $r_2(\text{max.})$	Height of raised spot of the installation to rail $H_1$	Height of raised spot of the installation to block $H_2$	$H_3$
25	1	1	4	5	6.5
30	1	1	4.5	5	7
35	1	1	5	6	7
45	1.5	1.5	6	8	9.5
55	1.5	1.5	8	10	10
65	1.5	2	9	10	13

## 4. Error tolerance of the mounting surface for installation

### 1) Auto-adjusting and error-absorbing abilities

A linear motion guide has an excellent auto-adjusting ability. Therefore, even though the structure with rail assembly is slightly deformed processing error may occur a little, the straightness or parallelism of a table after assembly is better than the precision in processing before assembly, and quite linear running is available.

### 2) Error tolerance of the degree of parallelization when using 2-axis assembly (P1)

The error tolerance of the degree of parallelization when a 2-axis assembly is used is shown below

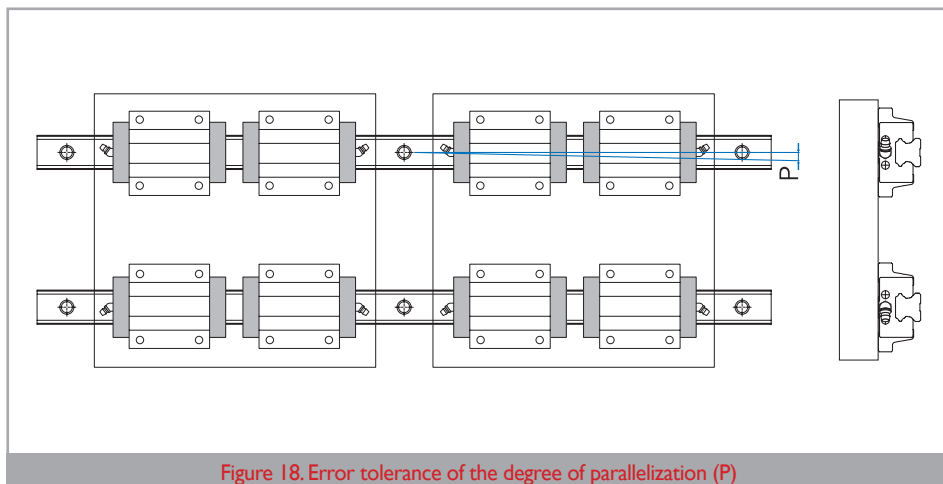

Figure 18. Error tolerance of the degree of parallelization (P)

H, H...S, HS, HS...S Series

Unit :  $\mu\text{m}$

Model No.	Common clearance	G1 clearance	G2 clearance
15	25	18	-
20	25	20	18
25	30	22	20
30	40	30	27
35	50	35	30
45	60	40	35
55	70	50	45



HB Series

Unit :  $\mu\text{m}$

Model No.	Common clearance	G <sub>1</sub> clearance	G <sub>2</sub> clearance
17	20	15	-
21	25	18	-
27	25	20	-
35	30	22	20

S, S...S Series

Unit :  $\mu\text{m}$

Model No.	Common clearance	G <sub>1</sub> clearance	G <sub>2</sub> clearance
15	25	18	-
20	25	20	18
25	30	22	20

M, MB Series

Unit :  $\mu\text{m}$

Model No.	Common clearance	G <sub>1</sub> clearance
5	2	-
7	3	-
9	4	3
12	9	5
13	10	6
15	10	6
20	13	8

R Series

Unit :  $\mu\text{m}$

Model No.	G <sub>2</sub> clearance	G <sub>3</sub> clearance
25	7	5
30	9	6
35	10	7
45	12	9
55	16	11
65	22	16

### 3) Error tolerance of height in 2-axis assembly (P<sub>2</sub>)

If an error of height in installation is too big, block distortion occurs and its rigidity may be weakened due to block distortion and changes in the raceway groove of the block and rail block and in the contact angle of a ball or roller as a rolling element.

The error tolerance of height level (x) when a 2-axis linear motion guide is used is as follows.

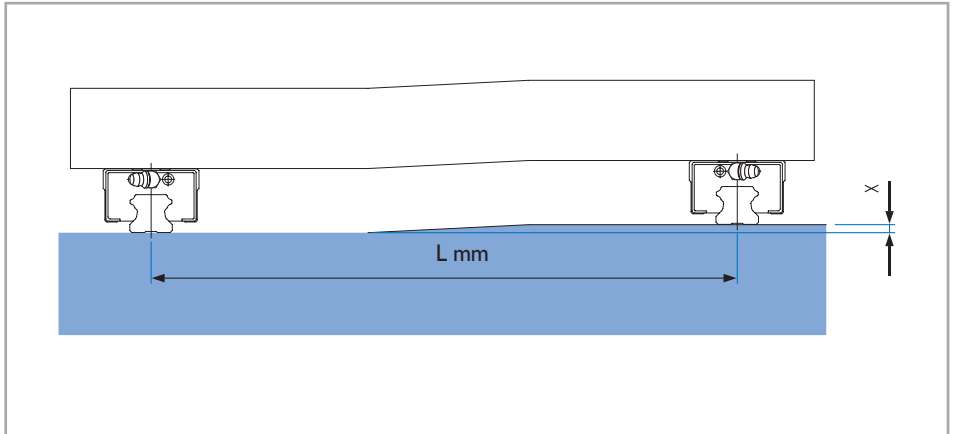

Figure 19. Error tolerance of height level in 2-axis (X)

H, H...S, S, S...S, HS, HS...S Series

Unit :  $\mu\text{m}$

Model No.	Common clearance	G <sub>1</sub> clearance	G <sub>2</sub> clearance
15	0.26L	0.17L	-
20	0.26L	0.17L	0.10L
25	0.26L	0.17L	0.14L
30	0.34L	0.22L	0.18L
35	0.42L	0.30L	0.24L
45	0.50L	0.34L	0.28L
55	0.60L	0.42L	0.34L

HB Series

Unit :  $\mu\text{m}$

Model No.	Common clearance	G <sub>1</sub> clearance	G <sub>2</sub> clearance
17	0.13L	0.04L	-
21	0.26L	0.17L	-
27	0.26L	0.17L	-
35	0.26L	0.17L	0.14L

M, MB Series

Unit :  $\mu\text{m}$

Model No.	Common clearance	G <sub>1</sub> clearance
5	0.04L	-
7	0.05L	-
9	0.07L	0.01L
12	0.10L	0.02L
13	0.12L	0.04L
15	0.12L	0.04L
20	0.14L	0.06L

R Series

Unit :  $\mu\text{m}$

Model No.	G <sub>2</sub> clearance	G <sub>3</sub> clearance
25, 30, 35, 45, 55, 65	0.17L	0.12L

## 5. Description of the datum plane for installation

The datum plane of WON ST Linear Motion Guide is the ground surface on the opposite side of WON mark shown in the block.

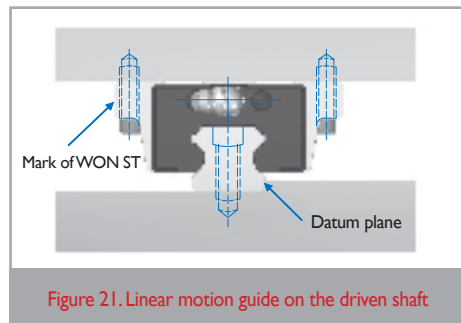
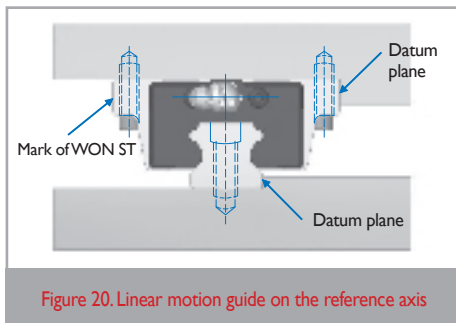

## 6. Rail connection

If it is necessary to use a longer rail than the one supplied, it is possible to connect rails for the purpose of use. The mark on the rail indicates the point where rails should be linked. If a block passes through the connecting points simultaneously, that may affect travel of the unit or cause a delicate hitch. To solve this problem, it is recommended to make the connecting points intercrossed.

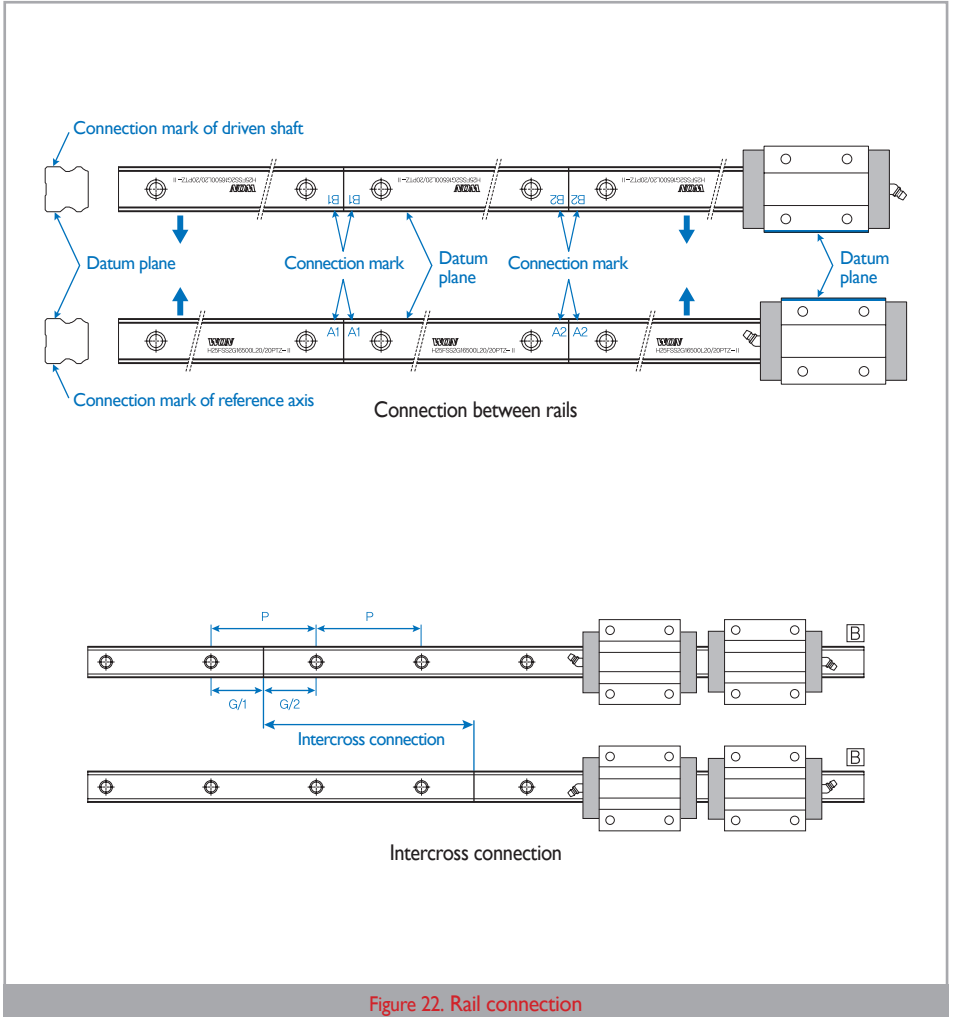
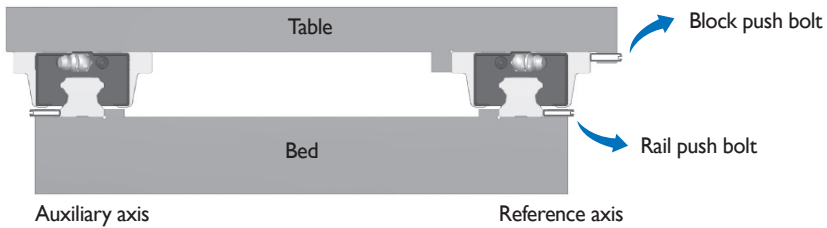

Figure 22. Rail connection

## 7. Installation

1) Installation of linear motion guide in the equipment exposed to vibration and impacts



Install a rail

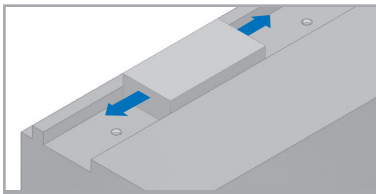

**Step 1:** Check the installation surface for a rail.

Prior to installation, remove burr, dust, and dust prevention oil completely.

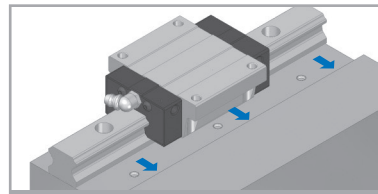

**Step 2:** Draw a rail tightly to the datum plane

Gently place a linear motion guide on the bed, and push it in the opposite direction of datum plan of the bed.

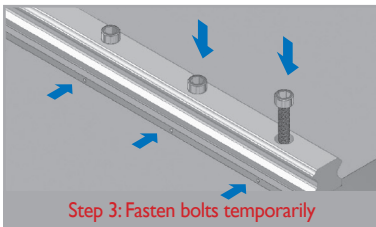

**Step 3:** Fasten bolts temporarily

Check the status of bolts and fasten every bolt temporarily.

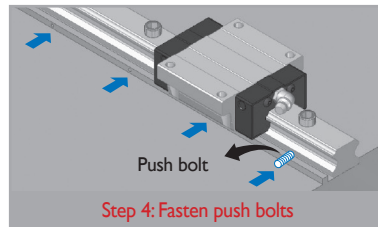

**Step 4:** Fasten push bolts

Fix push bolts to make sure that the rail is in parallel with the datum plane of the bed.

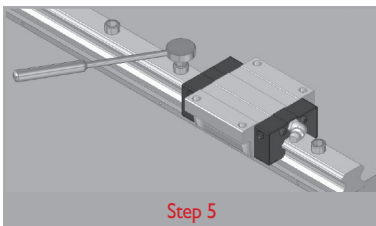

**Step 5**

**•Step 5:** Fasten all bolts with a torque wrench.

Fasten all bolts at the recommended torque. Fasten the bolt in the center first and then continue fastening each bolt toward both ends in order to maintain precision of the rail in the assembly process.

**•Step 6:** Assemble an auxiliary axis.

Repeat the above procedure for the installation of an auxiliary axis.

□ Install a block

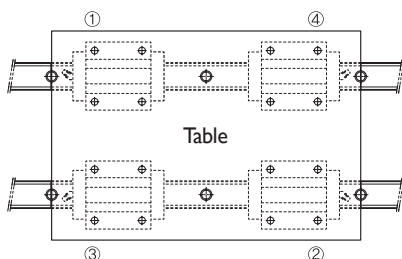

•Step 1: Assembly bolts temporarily

Place a table on the block and fasten all bolts temporarily.

•Step 2: Fasten bolts tightly

Fix the main rail block to the opposite side of datum plane of the table with the use of a push bolt, and adjust position of the table.

•Step 3: Fix and fasten assembly bolts

Completely fasten all bolts on the datum plane and subsidiary side in the order of □ to □.

2) Installation of linear motion guide without a push bolt

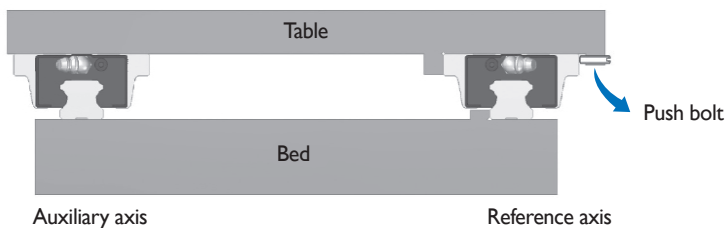

Install a master rail

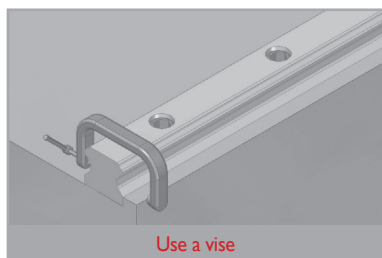

Fasten bolts temporarily and push a master rail toward the datum plane using a C-vise. Fasten the bolts sequentially at the prescribed torque.

Install an auxiliary rail

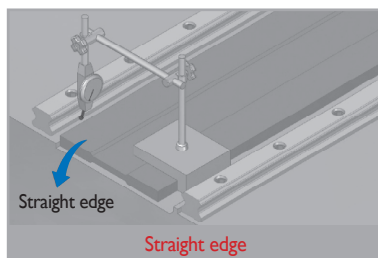

Place a straight edge in between two rails, and make it in parallel with the master rail fixed temporarily. Check the degree of parallelism with a dial gauge, and adjust the rail if needed. And then, fasten bolts in order

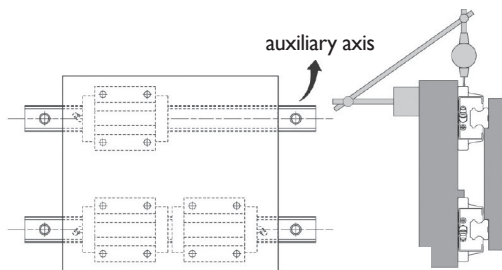

•**Assembly using a table**

1. Fix two blocks on the datum plane and one block on the auxiliary axis to a table.
2. Fix another auxiliary block and rail to the table and bed temporarily.
3. Place a dial gauge on the table and make sure that a probe of the gauge contacts the auxiliary axis of the block.
4. Separate the table from the end of the rail, and check parallelization between the block and the auxiliary rail.
5. Fasten bolts in order.

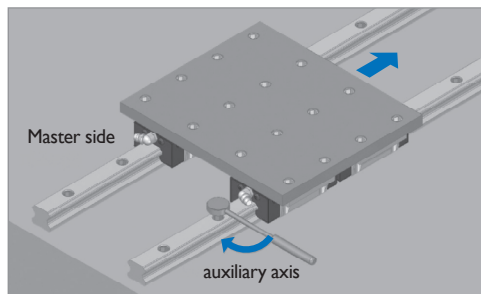

•**Assembly using a rail on the reference axis**

1. Fix two blocks on the datum plane and one block on the auxiliary axis to a table.
2. Fix another auxiliary block and rail to the table and bed temporarily.
3. Separate the table from one rail and make adjustment in the way of parallelization with the auxiliary rail in consideration of rolling resistance in movement.
4. Fasten bolts in order.

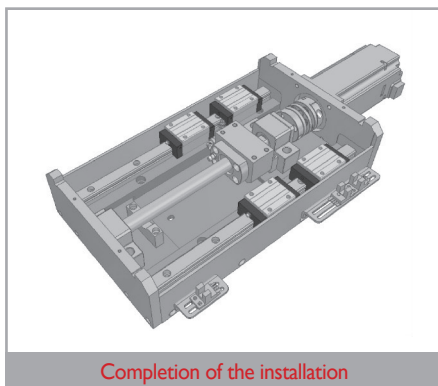
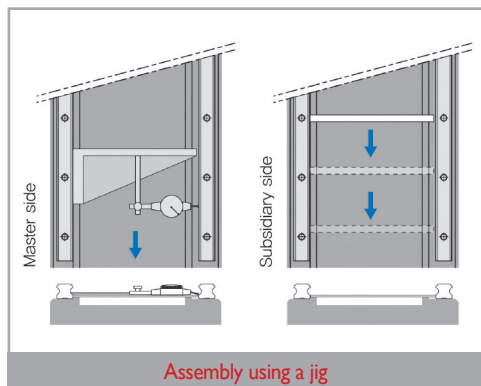

Move the position of a block sequentially at the end of the master rail every bolt pitch, and adjust parallelization between the datum plane of the master rail and the master plane of the auxiliary rail with the use of a special jig. Fasten bolts in order.

### 3) Installation of a block without the datum plane for a reference rail

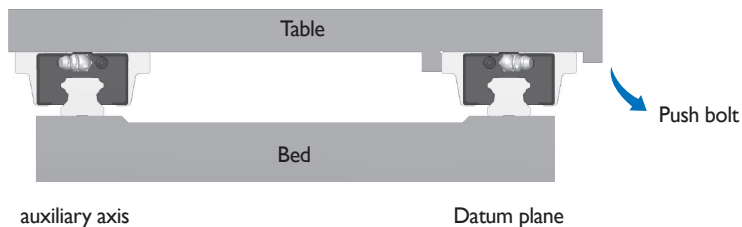

#### Install a reference rail

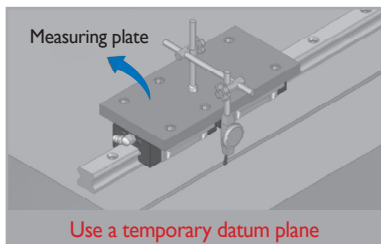

Fix two blocks together onto the measuring plate and install a temporary datum plane near the rail mounting on the bed. Check the degree of parallelism of the rail, and fasten bolts in order.

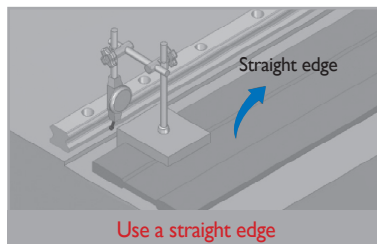

Fix a rail to the bed temporarily. Adjust it to be in straight life with the use of a dial gauge. Fasten bolts in order.

Apply the same method when installing an auxiliary block and rail.

#### 4) Measure precision after installation

It is possible to check the precision of travel by fixing two blocks onto the measuring plate. To measure precision, either use a straight edge and check a measurement with a dial gauge, or use a laser interferometer.

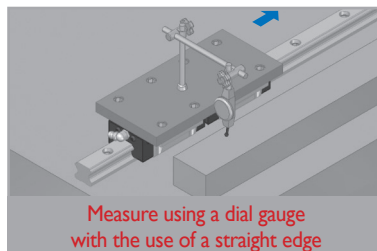
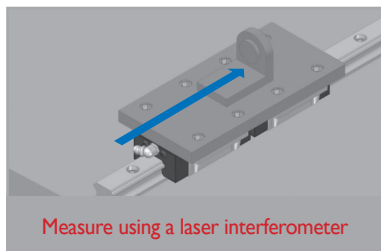



## 8. Torque used for fastening bolts in assembly

1) Select the optimal torque for bolts

To assemble a rail of a linear motion guide, it is required to apply bolt torque appropriately in consideration of the material of the mounting surface or bolts. Inaccurate bolt torque may affect the mounting precision of the rail. So please use a torque wrench.

2) Recommended torque by the material of the mounting base

Unit : N · m

Bolt specification	Torque value (Unit : N · m)		
	Steel	Casting	Aluminum
M3	2	1.3	1
M4	4	2.7	2
M5	8.8	5.9	4.4
M6	13.7	9.2	6.8
M8	30	20	15
M10	68	45	33
M12	120	78	58
M14	157	105	78
M16	196	131	98
M20	382	255	191

3) Recommended torque by the material of bolts

Unit : N · m

Bolt specification	Bolt torque	
	Carbon steel bolt	SCM steel bolt
M2.3	-	0.4
M2.5	-	0.6
M3	1.7	1.1
M4	4.0	2.5
M5	7.9	5.1
M6	13.3	8.6
M8	32.0	22.0
M10	62.7	43.0

Bolt specification	Bolt torque	
	Carbon steel bolt	SCM steel bolt
M12	108	76
M14	172	122
M16	263	196
M18	-	265
M20	512	-
M22	-	520
M24	882	-
M30	1750	-

## 9. Bolt fastening direction by linear motion guide type

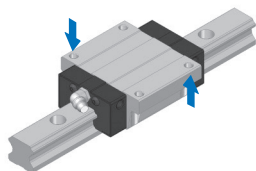

### H-FN, H-FL, HB-F, H-FN...S, H-FL...S

Since the flange of a block is tap-processed and the counter bore is processed in the bottom, it is possible to tighten bolts in the up and down direction as indicated by the arrows.

But, to fasten bolts from bottom to top, it is recommended to use one size smaller.

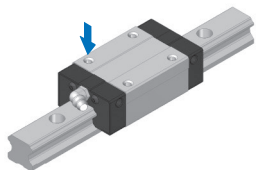

### H-RN, H-RL, HB-R, H-RN...S, H-RL...S

Since the square body of the block is tap-processed, it is used at the time when bolts need to be fastened from top to bottom as indicated by the arrow

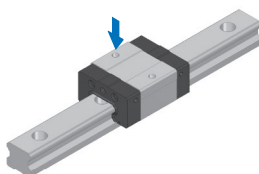

### S-RC, S-RN, S-RC...S, S-RN...S

Since the square body of the block is tap-processed, it is used at the time when bolts need to be fastened from top to bottom as indicated by the arrow

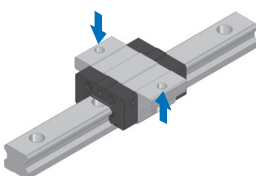

### S-FC, S-FN, S-FC...S, S-FN...S

Since the flange of a block is tap-processed and the counter bore is processed in the bottom, it is possible to tighten bolts in the up and down direction as indicated by the arrows.

But, to fasten bolts from bottom to top, it is recommended to use one size smaller.

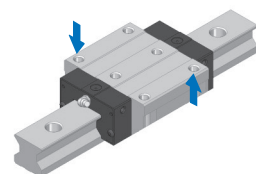

### R-FN, R-FL

Since the flange of a block is tap-processed and the counter bore is processed in the bottom, it is possible to tighten bolts in the up and down direction as indicated by the arrows.

But, to fasten bolts from bottom to top, it is recommended to use one size smaller.

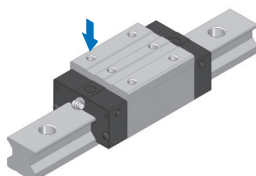

### R-RN, R-RL, RS-RN, RS-RL

Since the square body of the block is tap-processed, it is used at the time when bolts need to be fastened from top to bottom as indicated by the arrow.

## 12 Types of Linear Motion Guide

### I. Linear Motion Guide H Series

#### 1) Structure of H Series

WON Linear Motion Guide H Series has a four-row circular arc-groove structure in the raceway groove of a rail or block. In addition, it has a 4-direction equal load type in which it can bear equal load rating for vertical compression load, tensile load, and horizontal load as its ball as a rolling element is combined at 45 degree. Therefore, the model reduces friction resistance and ensures smooth motion and long life. By imposing preload on the balls, it is possible to enhance the rigidity of a linear motion guide and to minimize its deformation for external load.

#### 2) Features of H Series

- a. High quality, high precision, and elimination of labor.
- b. High rigidity and high precision for implementing stable travel precision for a long time.
- c. Excellent wear resistance and friction resistance that ensure a long life.
- d. The face-to-face duplex structure just like the D/F combination of ball bearing, excellent at auto-adjusting and error-absorbing.
- e. Various specifications for easy design.
- f. Easy to use due to high compatibility of rail and block.

### 2. Spacer Chain Linear Motion Guide H...SSeries

#### 1) Structure of H...S Series

Like H Series, Linear Motion Guide H...S Series has the 4-direction equal load type and auto-adjusting face-to-face D/F structure. It uses a ball as a rolling element and has a spacer between balls to prevent them from colliding each other in rolling motion. Since it makes less noise and more stable circulating motion than a full-ball type, it is possible to implement quiet running at high speed. In addition, the spacer can serve as a pocket of a lubricant.

#### 2) Features of H...S Series

- a. As a spacer-incorporated type that improves frictional properties and prevents the collision of balls, the model not only allows stable circulating motion and smooth running but also reduces noise. By attaching a special lubricating seal for a longer life span, it is possible to be free of maintenance.
- b. Since a resin spacer is applied to the model, it is possible to prevent the collision of balls and the loss of oil film, and to generate less particles and dust.
- c. High quality, high precision, and elimination of labor.
- d. High rigidity and high precision for implementing stable travel precision for a long time.
- e. Excellent wear resistance and friction resistance that ensure a long life.
- f. The face-to-face duplex structure just like the D/F combination of ball bearing, excellent at auto-adjusting and error-absorbing.
- g. Various specifications for easy design.
- h. Easy to use due to high compatibility of rail and block.

## Linear Motion Guide H Series, H...S Series

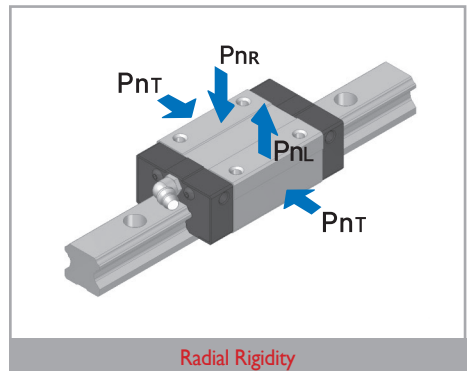
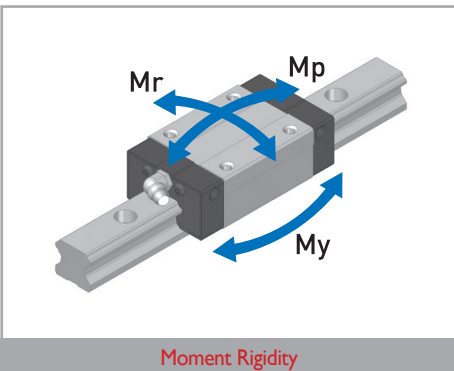
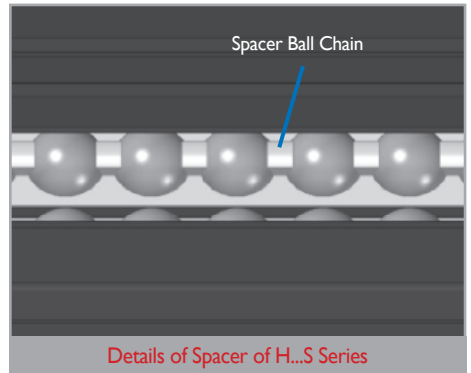
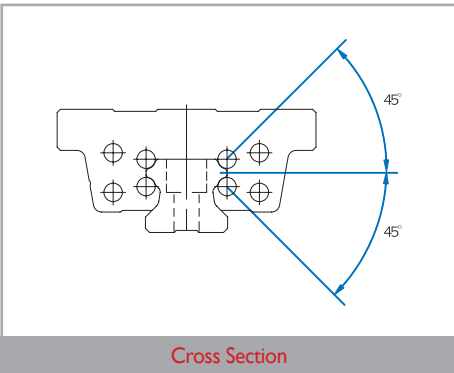
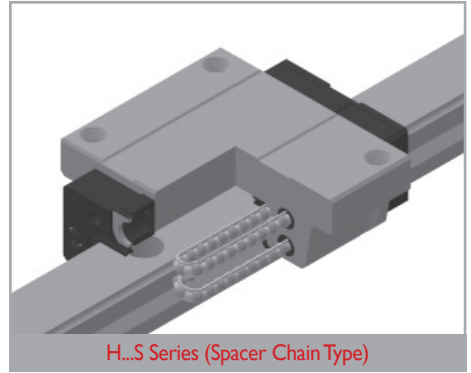
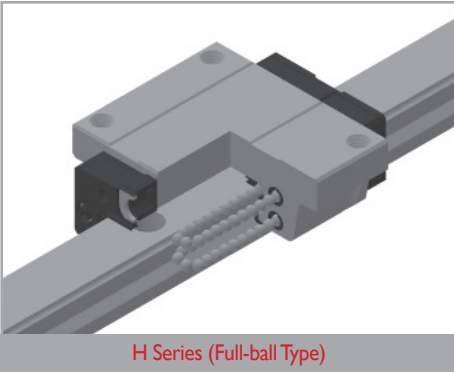

Types and Features

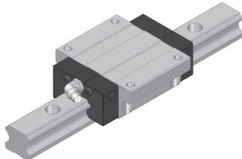
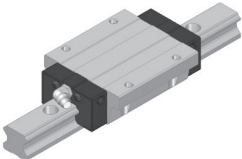
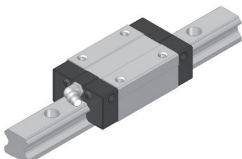
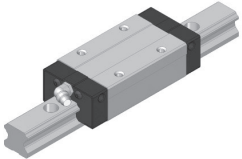
Category	Type	Shape & Feature		
Flange type	H-F H-F...S		<ul style="list-style-type: none"> <li>•A general type with the tap-machined flange of a block, supporting installation from bottom to top and from top to bottom</li> <li>•4-direction equal load type with high rigidity and high load</li> </ul> <p><i>S Series are types with a spacer retainer helping to reduce ball-to-ball friction and generate less noise and dust</i></p>	Machine tool X,Y, & Z axes, CNC machining center, CNC lathe, CNC tapping center, Electric injection machine, 3D engraving machine, Laser processor, Milling machine, Welder for exclusive use, EDM electric spark machine, Automation device, Multi-transport system, FPD inspection equipment, Industrial robot, Precision X-Y table, Various industrial machines
	H-FL H-FL...S		<ul style="list-style-type: none"> <li>•The same cross section as in H-F Series; increased load rating by enlarging the entire length (L<sub>1</sub>) of a block</li> <li>•4-direction equal load type with high rigidity and high load</li> </ul> <p><i>S Series are types with a spacer retainer helping to reduce ball-to-ball friction and generate less noise and dust</i></p>	
Compact type	H-R H-R...S		<ul style="list-style-type: none"> <li>•A compact type with the tap-machined top of a block, minimizing the width (W) of a block</li> <li>•4-direction equal load type with high rigidity and high load</li> </ul> <p><i>S Series are types with a spacer retainer helping to reduce ball-to-ball friction and generate less noise and dust</i></p>	
	H-RL H-RL...S		<ul style="list-style-type: none"> <li>•The same cross section as in H-R Series; increased load rating by enlarging the entire length (L<sub>1</sub>) of a block</li> <li>•4-direction equal load type with high rigidity and high load</li> </ul> <p><i>S Series are types with a spacer retainer helping to reduce ball-to-ball friction and generate less noise and dust</i></p>	

Standard and maximum lengths of a rail

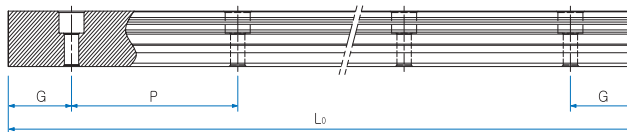

Unit : mm

Model No.	H15	H20	H25	H30	H35	H45	H55
Standard length	160	160	220	280	440	570	780
	220	220	280	360	520	675	900
	280	280	340	440	600	780	1000
	⋮	340	400	520	680	885	⋮
	1360	⋮	460	600	760	⋮	2820
	1480	1960	⋮	⋮	⋮	2880	2940
	1600	2080	2200	2520	2680	2985	3060
		2200	2320	2680	2840	3090	
Standard pitch P	60	60	60	80	80	105	120
G	20	20	20	20	20	22.5	30
Max. length	4000						

Standard tap hole type of a rail

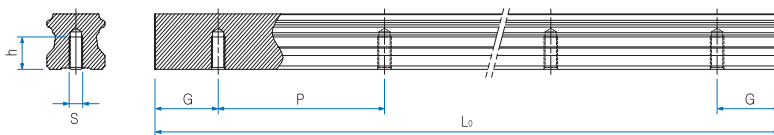

Model No.	S	h(mm)
H15	M5	8
H20	M6	10
H25	M6	12
H30	M8	15
H35	M8	17
H45	M12	24
H55	M14	24

## H-FN Series, H-FL Series

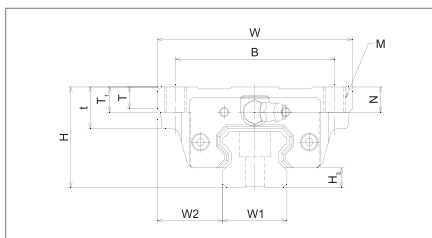
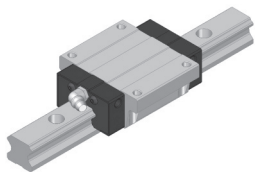

Model No.	External dimensions			Dimensions of block														Grease nipple	H <sub>3</sub>
	Height H	Width W	Length L	B	C	M	L <sub>1</sub>	t	T	T <sub>1</sub>	N	E	f	e	D				
H 15FN	24	47	56.5	38	30	M5	40.8	-	7	11	6	4.7	3.7	3.25	3.3	A-M5	4.5		
H 15FL	24	47	64.8	38	30	M5	49.1	-	7	11	6	4.7	3.7	3.25	3.3	A-M5	4.5		
H 20FN	30	63	73.2	53	40	M6	53.1	-	9.2	10	7.5	10.7	6.7	4.25	3.3	B-M6F	6.0		
H 20FL	30	63	89.1	53	40	M6	69	-	9.2	10	7.5	10.7	6.7	4.25	3.3	B-M6F	6.0		
H 25FN	36	70	83.2	57	45	M8	58.3	-	11.5	16	9	10.2	8	5	3.3	B-M6F	7.0		
H 25FL	36	70	103.1	57	45	M8	78.2	-	11.5	16	9	10.2	8	5	3.3	B-M6F	7.0		
H 30FN	42	90	99.3	72	52	M10	70.8	-	9.5	18	7.3	9.8	5	5.8	5.2	B-M6F	7.5		
H 30FL	42	90	121.5	72	52	M10	93	-	9.5	18	7.3	9.8	5	5.8	5.2	B-M6F	7.5		
H 35FN	48	100	111.8	82	62	M10	80.8	-	12.5	21	8	9.7	6.5	6.5	5.2	B-M6F	9.0		
H 35FL	48	100	137.2	82	62	M10	106.2	-	12.5	21	8	9.7	6.5	6.5	5.2	B-M6F	9.0		
H 45FN	60	120	139.0	100	80	M12	101.9	25	13	15	10	16	8	8	3.3	B-PT1/8	10.0		
H 45FL	60	120	170.8	100	80	M12	133.7	25	13	15	10	16	8	8	3.3	B-PT1/8	10.0		
H 55FN	70	140	163.0	116	95	M14	117.5	29	19	17	11	16	8	9	3.3	B-PT1/8	13.0		
H 55FL	70	140	201.1	116	95	M14	155.6	29	19	17	11	16	8	9	3.3	B-PT1/8	13.0		

### Composition of Model Name & Number

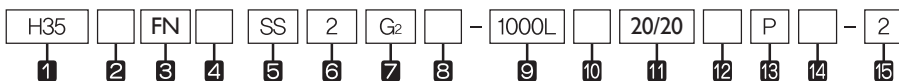

- 1 Model No. of Linear Motion Guide
- 2 Material of block : **No symbol**–Standard material / **M**–Stainless
- 3 Type of block : **RN**–Rectangular standard type / **RL**–Rectangular long type/ **FN**–Flange standard type / **FL**–Flange long type
- 4 **No symbol**–Standard block / **E**–Special block specification
- 5 Type of seal : **No symbol**–No seal / **UU**–End seal / **SS**–End seal+Side seal+Inner seal / **DD**–Double seal+Side seal+Inner seal / **ZZ**–End seal+Side seal+Inner seal+Metal scraper / **KK**–Double seal+Side seal+Inner seal+Metal scraper / **UULF**–End seal+LF seal / **SSLF**–End seal+Side seal+Inner seal+LF seal / **DDLFL**–Double seal+Side seal+Inner seal+LF seal / **ZZLFL**–End seal+Side seal+Inner seal+Metal scraper+LF seal / **KKLFL**–Double seal+Side seal+Inner seal+Metal scraper+LF seal (\*1)
- 6 Number of blocks assembled in one shaft
- 7 Symbol of clearance : **No symbol**–Normal preload / **G<sub>1</sub>**–Light preload / **G<sub>2</sub>**–Heavy preload / **G<sub>s</sub>**–Special preload (\*2)
- 8 Material of end plate : **No symbol** - Standard material / **I** - Stainless / **N** - Aluminum
- 9 Length of rail
- 10 Material of rail : **No symbol**–Standard material / **M**–Stainless
- 11 Size of G value: standard G value has no symbol
- 12 **No symbol**–Rail counterbore type (top assembly) / **A**–Rail tap hole type (bottom assembly) (\*3)
- 13 Symbol of precision : **No symbol**–Moderate / **H**–High / **P**–Precision / **SP**–Super precision / **UP**–Ultra precision (\*4)
- 14 **No symbol**–Standard rail / **E**–special rail specification
- 15 Number of axes used in the same plane

(\*1) See Symbol List of Optional Parts at page 113. (\*2) See Radial Clearance at page 30.

(\*3) See Standard Tap Hole Type of Rail at page 61. (\*4) See Selection of Precision Class at page 32.

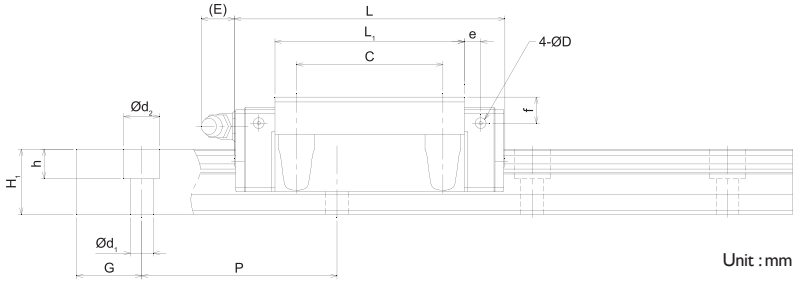

Width W <sub>1</sub> ±0.05	Dimensions of rail					Basic load rating		Static allowance moment ±N m					Mass		
	W <sub>2</sub>	Height H <sub>1</sub>	G	Pitch P	d <sub>1</sub> x d <sub>2</sub> x h	C kN	C <sub>0</sub> kN	M <sub>p</sub>		M <sub>y</sub>		M <sub>r</sub>		Block kg	Rail kg/m
								I block	Double blocks	I block	Double blocks	I block	Double blocks		
15	16	13	20	60	4.5x7.5x5.3	12.6	16.2	0.115	0.552	0.115	0.552	0.129	0.19	1.3	
15	16	13	20	60	4.5x7.5x5.3	14.3	19.3	0.165	0.769	0.165	0.769	0.154	0.24	1.3	
20	21.5	16.5	20	60	6x9.5x8.5	18.3	23.9	0.221	1.049	0.221	1.049	0.251	0.41	2.2	
20	21.5	16.5	20	60	6x9.5x8.5	21.8	30.7	0.370	1.692	0.370	1.692	0.322	0.54	2.2	
23	23.5	20	20	60	7x11x9	27.0	33.1	0.337	1.636	0.337	1.636	0.398	0.61	3.0	
23	23.5	20	20	60	7x11x9	32.8	43.6	0.596	2.760	0.596	2.760	0.525	0.82	3.0	
28	31	26	20	80	9x14x12	50.4	57.1	0.711	3.384	0.711	3.384	0.828	1.1	4.85	
28	31	26	20	80	9x14x12	60.3	73.6	1.203	5.506	1.203	5.506	1.067	1.3	4.85	
34	33	29	20	80	9x14x12	67.0	74.6	1.062	5.012	1.062	5.012	1.298	1.6	6.58	
34	33	29	20	80	9x14x12	80.2	96.2	1.797	8.172	1.797	8.172	1.674	2.01	6.58	
45	37.5	38	22.5	105	14x20x17	108.5	116.4	2.860	9.912	2.860	9.912	2.275	2.83	11.03	
45	37.5	38	22.5	105	14x20x17	129.7	150.1	4.533	16.161	4.533	16.161	2.935	3.70	11.03	
53	43.5	44	30	120	16x23x20	155.9	161.5	4.654	16.016	4.654	16.016	3.779	4.36	15.26	
53	43.5	44	30	120	16x23x20	187.5	210.1	7.468	26.493	7.468	26.493	4.916	5.76	15.26	

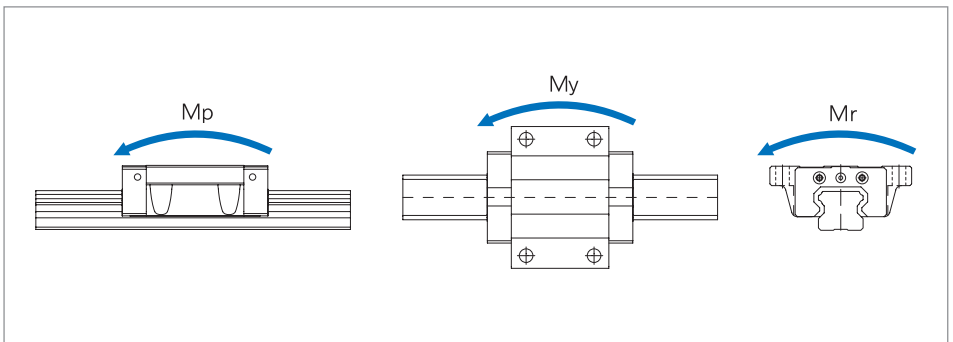



## H-RN Series, H-RL Series

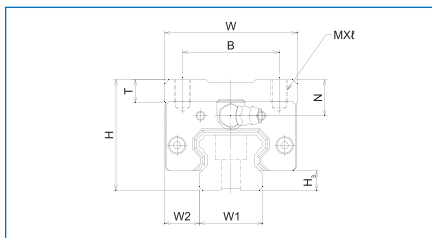
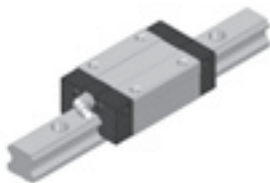

Model No.	External dimensions			Dimensions of block										Grease nipple	H3
	Height H	Width W	Length L	B	C	MxØ	Li	T	N	E	f	e	D		
H15RN	28	34	56.5	26	26	M4 x 5	40.8	6	10	4.7	7.7	3.25	3.3	A-M5	4.5
H15RL	28	34	64.8	26	26	M4 x 5	49.1	6	10	4.7	7.7	3.25	3.3	A-M5	4.5
H20RN	30	44	73.2	32	36	M5 x 6	53.1	8	7.5	10.7	6.7	4.25	3.3	B-M6F	6.0
H20RL	30	44	89.1	32	50	M5 x 6	69	8	7.5	10.7	6.7	4.25	3.3	B-M6F	6.0
H25RN	40	48	83.2	35	35	M6 x 8	58.3	8	13	10.2	12	5	3.3	B-M6F	7.0
H25RL	40	48	103.1	35	50	M6 x 8	78.2	8	13	10.2	12	5	3.3	B-M6F	7.0
H30RN	45	60	99.3	40	40	M8 x 10	70.8	8	10.3	9.8	8	5.8	5.2	B-M6F	7.5
H30RL	45	60	121.5	40	60	M8 x 10	93	8	10.3	9.8	8	5.8	5.2	B-M6F	7.5
H35RN	55	70	111.8	50	50	M8 x 12	80.8	10	15	9.7	13.5	6.5	5.2	B-M6F	9.0
H35RL	55	70	137.2	50	72	M8 x 12	106.2	10	15	9.7	13.5	6.5	5.2	B-M6F	9.0
H45RN	70	86	139.0	60	60	M10 x 17	101.9	15	20	16	18	8	3.3	B-PT1/8	10.0
H45RL	70	86	170.8	60	80	M10 x 17	133.7	15	20	16	18	8	3.3	B-PT1/8	10.0
H55RN	80	100	163.0	75	75	M12 x 18	117.5	18	21	16	18	9	3.3	B-PT1/8	13.0
H55RL	80	100	201.1	75	95	M12 x 18	155.6	18	21	16	18	9	3.3	B-PT1/8	13.0

### Composition of Model Name & Number

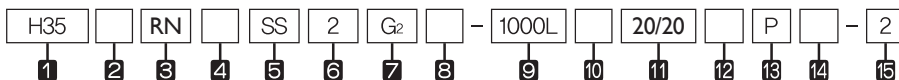

- 1 Model No. of Linear Motion Guide
- 2 Material of block : **No symbol**–Standard material / **M**–Stainless
- 3 Type of block : **RN**–Rectangular standard type / **RL**–Rectangular long type / **FN**–Flange standard type / **FL**–Flange long type
- 4 **No symbol**–Standard block / **E**–Special block specification
- 5 Type of seal : **No symbol**–No seal / **UU**–End seal / **SS**–End seal+Side seal+Inner seal / **DD**–Double seal+Side seal+Inner seal / **ZZ**–End seal+Side seal+Inner seal+Metal scraper / **KK**–Double seal+Side seal+Inner seal+Metal scraper / **UULF**–End seal+LF seal / **SSLF**–End seal+Side seal+Inner seal+LF seal / **DDLFL**–Double seal+Side seal+Inner seal+LF seal / **ZZLFL**–End seal+Side seal+Inner seal+Metal scraper+LF seal / **KKLFL**–Double seal+Side seal+Inner seal+Metal scraper+LF seal (\*1)
- 6 Number of blocks assembled in one shaft
- 7 Symbol of clearance : **No symbol**–Normal preload / **G1**–Light preload / **G2**–Heavy preload / **Gs**–Special preload (\*2)
- 8 Material of end plate : **No symbol** – Standard material / **I** – Stainless / **N** – Aluminum
- 9 Length of rail
- 10 Material of rail : **No symbol**–Standard material / **M**–Stainless
- 11 Size of G value: standard G value has no symbol
- 12 **No symbol**–Rail counterbore type (top assembly) / **A**–Rail tap hole type (bottom assembly) (\*3)
- 13 Symbol of precision : **No symbol**–Moderate / **H**–High / **P**–Precision / **SP**–Super precision / **UP**–Ultra precision (\*4)
- 14 **No symbol**–Standard rail / **E**–special rail specification
- 15 Number of axes used in the same plane

(\*1) See Symbol List of Optional Parts at page 113. (\*2) See Radial Clearance at page 30.

(\*3) See Standard Tap Hole Type of Rail at page 61. (\*4) See Selection of Precision Class at page 32.

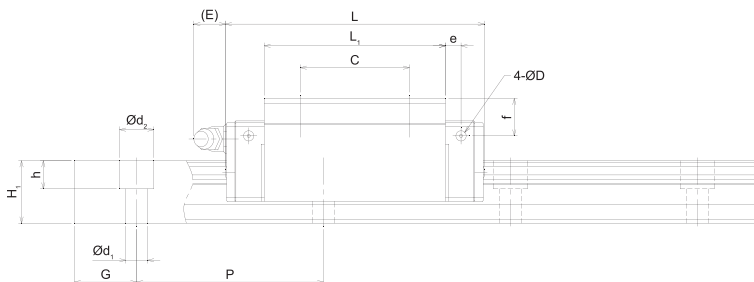

Unit : mm

Dimensions of rail						Basic load rating		Static allowance moment $\cdot$ N m					Mass	
Width $W_1$ $\pm 0.05$	$W_2$	Height $H_1$	G	Pitch P	$d_1 \times d_2 \times h$	C kN	$C_0$ kN	$M_p$		$M_y$		$M_r$	Block kg	Rail kg/m
								1 block	Double blocks	1 block	Double blocks	1 block		
15	9.5	13	20	60	4.5x7.5x5.3	12.6	16.2	0.115	0.552	0.115	0.552	0.129	0.18	1.3
15	9.5	13	20	60	4.5x7.5x5.3	14.3	19.3	0.165	0.769	0.165	0.769	0.154	0.23	1.3
20	12	16.5	20	60	6x9.5x8.5	18.3	23.9	0.221	1.049	0.221	1.049	0.251	0.31	2.2
20	12	16.5	20	60	6x9.5x8.5	21.8	30.7	0.370	1.692	0.370	1.692	0.322	0.41	2.2
23	12.5	20	20	60	7x11x9	27.0	33.1	0.337	1.636	0.337	1.636	0.398	0.53	3.0
23	12.5	20	20	60	7x11x9	32.8	43.6	0.596	2.760	0.596	2.760	0.525	0.71	3.0
28	16	26	20	80	9x14x12	50.4	57.1	0.711	3.384	0.711	3.384	0.828	0.9	4.85
28	16	26	20	80	9x14x12	60.3	73.6	1.203	5.506	1.203	5.506	1.067	1.1	4.85
34	18	29	20	80	9x14x12	67.0	74.6	1.062	5.012	1.062	5.012	1.298	1.5	6.58
34	18	29	20	80	9x14x12	80.2	96.2	1.797	8.172	1.797	8.172	1.674	2.01	6.58
45	20.5	38	22.5	105	14x20x17	108.5	116.4	2.860	9.912	2.860	9.912	2.275	2.89	11.03
45	20.5	38	22.5	105	14x20x17	129.7	150.1	4.533	16.161	4.533	16.161	2.935	3.74	11.03
53	23.5	44	30	120	16x23x20	155.9	161.5	4.654	16.016	4.654	16.016	3.779	4.28	15.26
53	23.5	44	30	120	16x23x20	187.5	210.1	7.468	26.493	7.468	26.493	4.916	5.59	15.26

$IN \square 0.102 \text{kgf}$

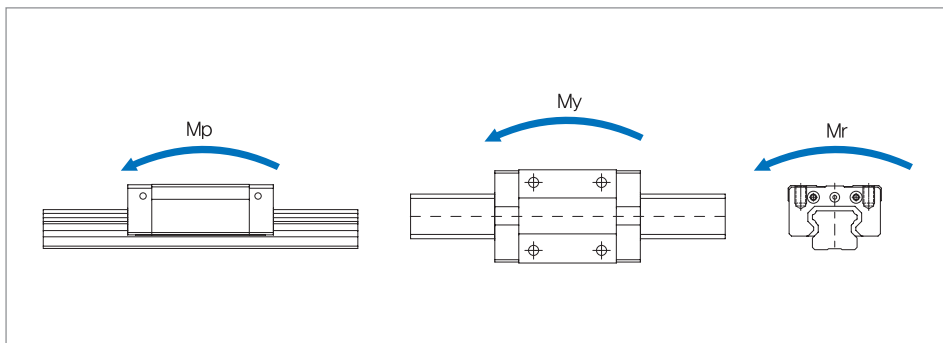

## H-FN...S Series, H-FL...S Series

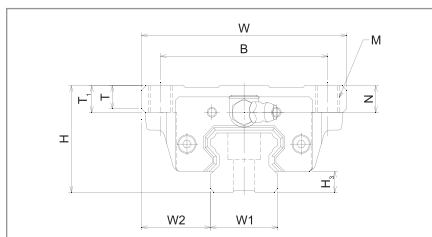
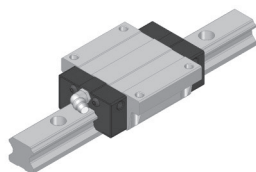

Model No.	External dimensions			Dimensions of block													
	Height H	Width W	Length L	B	C	M	Li	T	Ti	N	E	f	e	D	Grease nipple	H3	
H15FN...S	24	47	56.5	38	30	M5	40.7	7	11	6.0	4.7	3.7	3.25	3.3	A-M5	4.5	
H15FL...S	24	47	64.8	38	30	M5	49.1	7	11	6.0	4.7	3.7	3.25	3.3	A-M5	4.5	
H20FN...S	30	63	73.2	53	40	M6	53.1	9.2	10	7.5	10.7	6.7	4.25	3.3	B-M6F	6.0	
H20FL...S	30	63	89.1	53	40	M6	69.0	9.2	10	7.5	10.7	6.7	4.25	3.3	B-M6F	6.0	
H25FN...S	36	70	83.2	57	45	M8	58.3	11.5	16	9.0	10.2	8	5	3.3	B-M6F	7.0	
H25FL...S	36	70	103.1	57	45	M8	78.2	11.5	16	9.0	10.2	8	5	3.3	B-M6F	7.0	
H30FN...S	42	90	99.3	72	52	M10	70.8	9.5	18	7.3	9.8	5	5.8	5.2	B-M6F	7.5	
H30FL...S	42	90	121.5	72	52	M10	93.0	9.5	18	7.3	9.8	5	5.8	5.2	B-M6F	7.5	
H35FN...S	48	100	111.8	82	62	M10	80.8	12.5	21	8.0	9.7	6.5	6.5	5.2	B-M6F	9.0	
H35FL...S	48	100	137.2	82	62	M10	106.2	12.5	21	8.0	9.7	6.5	6.5	5.2	B-M6F	9.0	

### Composition of Model Name & Number

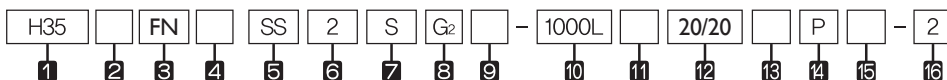

- 1 Model No.
- 2 Material of block: **No symbol**–Standard material / **M**–Stainless
- 3 Type of block: **RN**–Rectangular standard type / **RL**–Rectangular long type/ **FN**–Flange standard type / **FL**–Flange long type
- 4 **No symbol**–Standard block / **E**–Special block specification
- 5 Type of seal: **No symbol**–No seal / **UU**–End seal / **SS**–End seal+Side seal+Inner seal / **DD**–Double seal+Side seal+Inner seal / **ZZ**–End seal+Side seal+Inner seal+Metal scraper / **KK**–Double seal+Side seal+Inner seal+Metal scraper / **UULF**–End seal+LF seal / **SSLF**–End seal+Side seal+Inner seal+LF seal / **DDLf**–Double seal+Side seal+Inner seal+LF seal / **ZZLF**–End seal+Side seal+Inner seal+Metal scraper+LF seal / **KKLF**–Double seal+Side seal+Inner seal+Metal scraper+LF seal (\*1)
- 6 Number of blocks assembled in one shaft
- 7 **S**–Spacer chain type
- 8 Symbol of clearance: **No symbol**–Normal preload / **G1**–Light preload / **G2**–Heavy preload / **Gs**–Special preload (\*2)
- 9 Material of end plate: **No symbol** - Standard material / **I** - Stainless / **N** - Aluminum
- 10 Length of rail
- 11 Material of rail: **No symbol**–Standard material / **M**–Stainless
- 12 Size of G value: standard G value has no symbol
- 13 **No symbol**–Rail counterbore type (top assembly) / **A**–Rail tap hole type (bottom assembly) (\*3)
- 14 Symbol of precision: **No symbol**–Moderate / **H**–High / **P**–Precision / **SP**–Super precision / **UP**–Ultra precision (\*4)
- 15 **No symbol**–Standard rail / **E**–special rail specification
- 16 Number of axes used in the same plane

(\*1) See Symbol List of Optional Parts at page 113. (\*2) See Radial Clearance at page 30.

(\*3) See Standard Tap Hole Type of Rail at page 61. (\*4) See Selection of Precision Class at page 32.

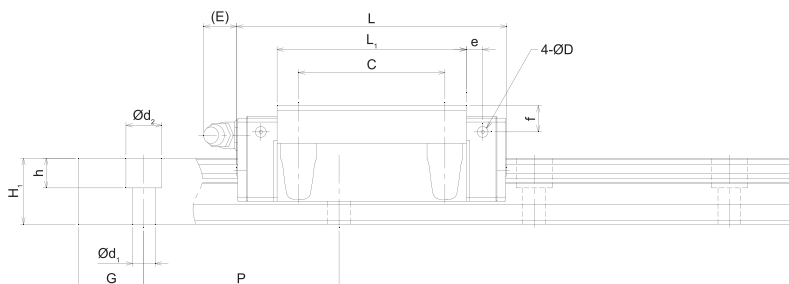

Unit : mm

Dimensions of rail						Basic load rating		Static allowance moment kN m					Mass	
Width $W_1$ $\pm 0.05$	$W_2$	Height $H_1$	$G$	Pitch $P$	$d_1 \times d_2 \times h$	$C$ kN	$C_0$ kN	$M_1$		$M_2$		$M_3$	Block kg	Rail kg/m
								1 block	Double blocks	1 block	Double blocks	1 block		
15	16	13	20	60	4.5x7.5x5.3	12.1	16.2	0.115	0.552	0.115	0.552	0.129	0.19	1.3
15	16	13	20	60	4.5x7.5x5.3	13.7	19.3	0.165	0.769	0.165	0.769	0.154	0.24	1.3
20	21.5	16.5	20	60	6x9.5x8.5	17.6	23.9	0.221	1.049	0.221	1.049	0.251	0.41	2.2
20	21.5	16.5	20	60	6x9.5x8.5	21.1	30.7	0.370	1.692	0.370	1.692	0.322	0.54	2.2
23	23.5	20	20	60	7x11x9	25.8	33.1	0.337	1.636	0.337	1.636	0.398	0.61	3.0
23	23.5	20	20	60	7x11x9	31.7	43.6	0.596	2.760	0.596	2.760	0.525	0.82	3.0
28	31	26	20	80	9x14x12	48	57.1	0.711	3.384	0.711	3.384	0.828	1.1	4.85
28	31	26	20	80	9x14x12	58	73.6	1.203	5.506	1.203	5.506	1.067	1.3	4.85
34	33	29	20	80	9x14x12	63.7	74.6	1.062	5.012	1.062	5.012	1.298	1.6	6.58
34	33	29	20	80	9x14x12	77.1	96.2	1.797	8.172	1.797	8.172	1.674	2.01	6.58

1N  $\approx$  0.102kgf

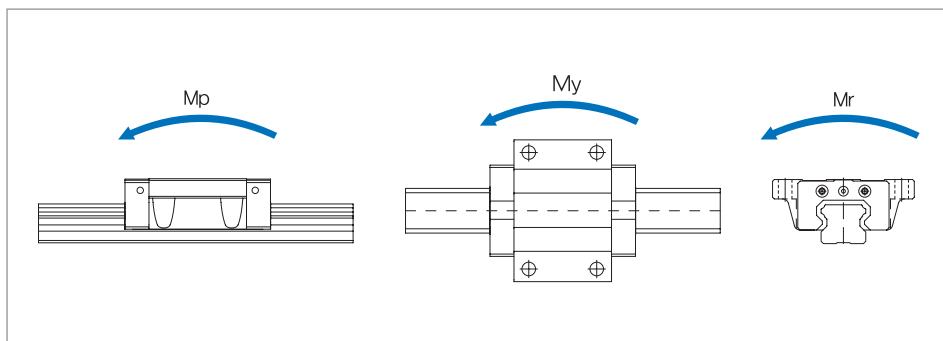

## H-RN...S Series, H-RL...S Series

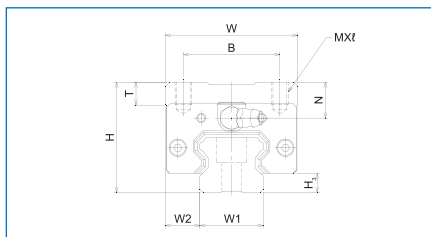
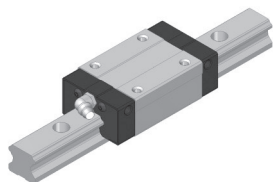

Model No.	External dimensions			Dimensions of block												
	Height H	Width W	Length L	B	C	Mxℓ	Li	T	N	E	f	e	D	Grease nipple	H3	
H 15RN...S	28	34	56.5	26	26	M4 x 5	40.7	6	10	4.7	7.7	3.25	3.3	A-M5	4.5	
H 15RL...S	28	34	64.8	26	26	M4 x 5	49.1	6	10	4.7	7.7	3.25	3.3	A-M5	4.5	
H 20RN...S	30	44	73.2	32	36	M5 x 6	53.1	8	7.5	10.7	6.7	4.25	3.3	B-M6F	6.0	
H 20RL...S	30	44	89.1	32	50	M5 x 6	69	8	7.5	10.7	6.7	4.25	3.3	B-M6F	6.0	
H 25RN...S	40	48	83.2	35	35	M6 x 8	58.3	8	13	10.2	12	5	3.3	B-M6F	7.0	
H 25RL...S	40	48	103.1	35	50	M6 x 8	78.2	8	13	10.2	12	5	3.3	B-M6F	7.0	
H 30RN...S	45	60	99.3	40	40	M8 x 10	70.8	8	10.3	9.8	8	5.8	5.2	B-M6F	7.5	
H 30RL...S	45	60	121.5	40	60	M8 x 10	93	8	10.3	9.8	8	5.8	5.2	B-M6F	7.5	
H 35RN...S	55	70	111.8	50	50	M8 x 12	80.8	10	15	9.7	13.5	6.5	5.2	B-M6F	9.0	
H 35RL...S	55	70	137.2	50	72	M8 x 12	106.2	10	15	9.7	13.5	6.5	5.2	B-M6F	9.0	

### Composition of Model Name & Number

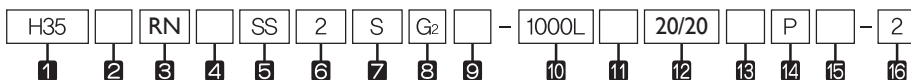

- 1 Model No.
- 2 Material of block : **No symbol**–Standard material / **M**–Stainless
- 3 Type of block : **RN**–Rectangular standard type / **RL**–Rectangular long type/ **FN**–Flange standard type / **FL**–Flange long type
- 4 **No symbol**–Standard block/ **E**–Special block specification
- 5 Type of seal : **No symbol**–No seal / **UU**–End seal / **SS**–End seal+Side seal+Inner seal / **DD**–Double seal+Side seal+Inner seal / **ZZ**–End seal+Side seal+Inner seal+Metal scraper / **KK**–Double seal+Side seal+Inner seal+Metal scraper / **UULF**–End seal+LF seal / **SSLF**–End seal+Side seal+Inner seal+LF seal / **DDLFL**–Double seal+Side seal+Inner seal+LF seal / **ZZLF**–End seal+Side seal+Inner seal+Metal scraper+LF seal / **KKLFL**–Double seal+Side seal+Inner seal+Metal scraper+LF seal (\*1)
- 6 Number of blocks assembled in one shaft
- 7 **S**–Spacer chain type
- 8 Symbol of clearance : **No symbol**–Normal preload / **G1**–Light preload / **G2**–Heavy preload / **G5**–Special preload (\*2)
- 9 Material of end plate : **No symbol** – Standard material / **I** – Stainless / **N** – Aluminum
- 10 Length of rail
- 11 Material of rail : **No symbol**–Standard material / **M**–Stainless
- 12 Size of G value: standard G value has no symbol
- 13 **No symbol**–Rail counterbore type (top assembly) / **A**–Rail tap hole type (bottom assembly) (\*3)
- 14 Symbol of precision : **No symbol**–Moderate / **H**–High / **P**–Precision / **SP**–Super precision / **UP**–Ultra precision (\*4)
- 15 **No symbol**–Standard rail / **E**–special rail specification
- 16 Number of axes used in the same plane

(\*1) See Symbol List of Optional Parts at page 113. (\*2) See Radial Clearance at page 30.

(\*3) See Standard Tap Hole Type of Rail at page 61. (\*4) See Selection of Precision Class at page 32.

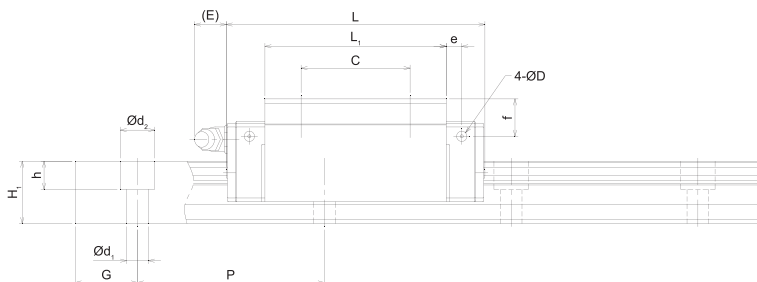

Unit: mm

Width W <sub>1</sub> ±0.05	Dimensions of rail					Basic load rating		Static allowance moment i N m					Mass	
	W <sub>2</sub>	Height H <sub>1</sub>	G	Pitch P	d <sub>1</sub> x d <sub>2</sub> x h	C iN	C <sub>0</sub> iN	M <sub>p</sub>		M <sub>y</sub>		M <sub>r</sub>	Block kg	Rail kg/m
								1 block	Double blocks	1 block	Double blocks	1 block		
15	9.5	13	20	60	4.5x7.5x5.3	12.1	16.2	0.115	0.552	0.115	0.552	0.129	0.18	1.3
15	9.5	13	20	60	4.5x7.5x5.3	13.7	19.3	0.165	0.769	0.165	0.769	0.154	0.23	1.3
20	12	16.5	20	60	6x9.5x8.5	17.6	23.9	0.221	1.049	0.221	1.049	0.251	0.31	2.2
20	12	16.5	20	60	6x9.5x8.5	21.1	30.7	0.370	1.692	0.370	1.692	0.322	0.41	2.2
23	12.5	20	20	60	7x11x9	25.8	33.1	0.337	1.636	0.337	1.636	0.398	0.53	3.0
23	12.5	20	20	60	7x11x9	31.7	43.6	0.596	2.760	0.596	2.760	0.525	0.71	3.0
28	16	26	20	80	9x14x12	48	57.1	0.711	3.384	0.711	3.384	0.828	0.9	4.85
28	16	26	20	80	9x14x12	58	73.6	1.203	5.506	1.203	5.506	1.067	1.1	4.85
34	18	29	20	80	9x14x12	63.7	74.6	1.062	5.012	1.062	5.012	1.298	1.5	6.58
34	18	29	20	80	9x14x12	77.1	96.2	1.797	8.172	1.797	8.172	1.674	2.01	6.58

1N ≈ 0.102kgf

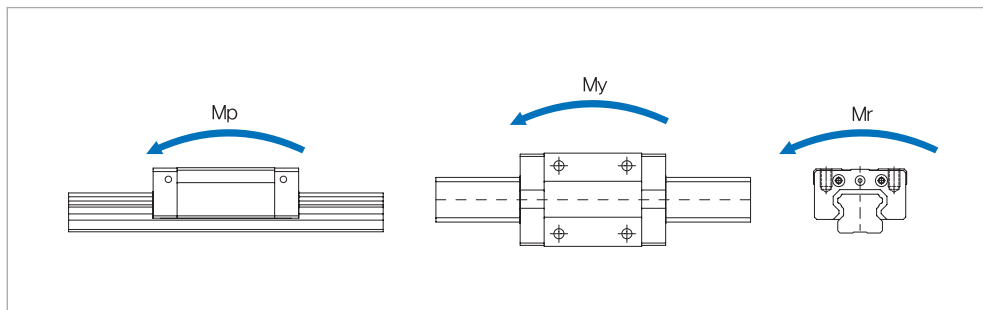

### 3. Wide Linear Motion Guide HB Series

#### 1) Structure of HB Series

WON Wide Linear Motion Guide HB Series has a four-row circular arc-groove structure in the raceway groove of a rail or block. In addition, it has a 4-direction equal load type in which it can bear equal load rating for vertical compression load, tensile load, and horizontal load as its ball as a rolling element is combined at 45 degree. Therefore, the model reduces friction resistance and ensures smooth motion and long life. Since the model has a wide and short rail, moment works only with one shaft in a narrow space. It is applicable to place that requires high rigidity.

#### 2) Features of HB Series

- a. High quality, high precision, and elimination of labor.
- b. High rigidity and high precision for implementing stable travel precision for a long time.
- c. Excellent wear resistance and friction resistance that ensure a long life.
- d. The face-to-face duplex structure just like the D/F combination of ball bearing, excellent at auto-adjusting and error-absorbing.
- e. A higher quantity of balls than that of H Series; higher rigidity and wider rail; sufficient moment working only with one shaft

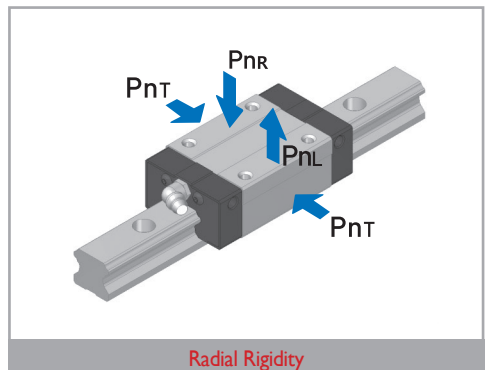
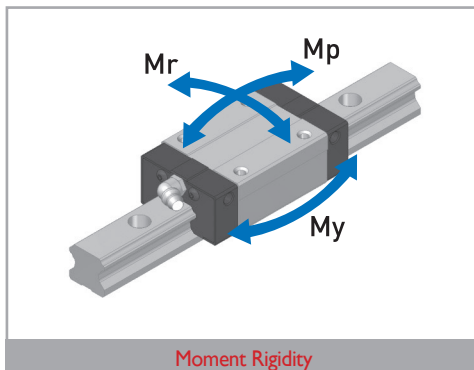
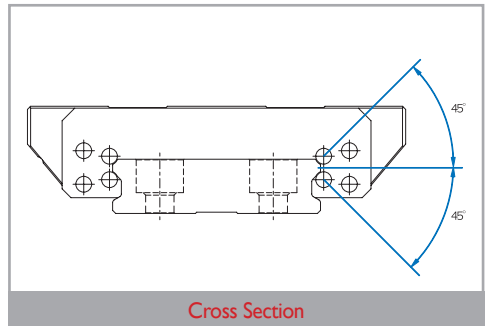
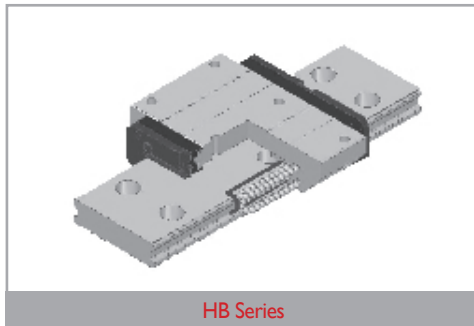

## Types and Features

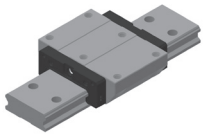
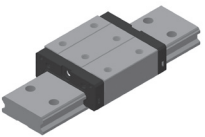
Category	Type	Shape & Feature		
Flange type	HB-F		<ul style="list-style-type: none"> <li>•A general type with the tap-processed flange of a block, supporting installation from bottom to top and from top to bottom</li> <li>•4-direction equal load type with high rigidity and high load</li> </ul>	Electric spark machine Loader CNC lathe Industrial robot Semiconductor display manufacturing equipment Measuring equipment Wafer transfer equipment Construction equipment Railway vehicle
Compact type	HB-R		<ul style="list-style-type: none"> <li>•A compact type with the tap-processed top of a block and without flange</li> <li>•4-direction equal load type with high rigidity and high load</li> </ul>	

### Standard and maximum lengths of rail

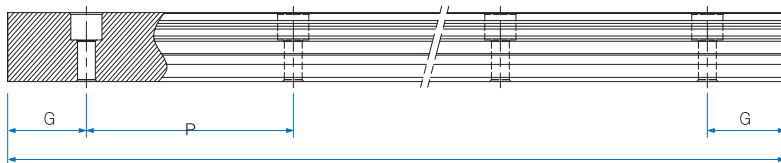

Unit : mm

Model No.	HB17	HB21	HB27	HB35
Standard length	110	130	160	280
	230	230	280	440
	350	380	400	680
	470	480	640	840
	550	530	880	1000
	1990	1930	3820	3800
		1980	3880	3960
			3940	
Standard pitch P	40	50	60	80
G	15	15	20	20
Max. length	2000		4000	



## HB-F Series

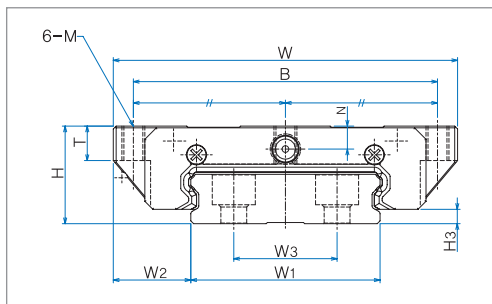
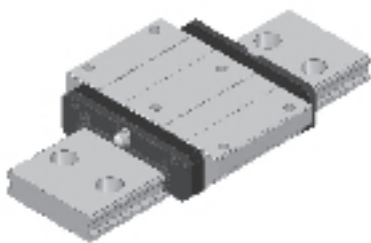

Model No.	External dimensions			Dimensions of block								Grease nipple	H <sub>3</sub>
	Height H	Width W	Length L	B	C	M	L <sub>1</sub>	T	N	E			
HB17F	17	60	51	53	26	M4	37.4	6	4	3.5	A-Ø3	2.5	
HB21F	21	68	59	60	29	M5	45.4	8	5	3.5	A-Ø3	3.3	
HB27F	27	80	72.5	70	40	M6	54.7	10	6	10.3	B-M6F	3.5	
HB35F	35	120	105.3	107	60	M8	82.1	14	7.6	10.3	B-M6F	4	

### Composition of Model Name & Number



- 1 Model No.
- 2 Type of block : F-Flange standard type / R-Rectangular standard type
- 3 No symbol-Standard block / E-Special block specification
- 4 Type of seal : No symbol-No seal / UU-End seal / SS-End seal+ Inside seal / ZZ-End seal+ Inside seal+ Metal scraper/ UULF-End seal+ LF seal / SSLF-End seal+ Inside seal+ LF seal / ZZLF-End seal+ Inside seal+ Metal scraper + LF seal (\*1)
- 5 Number of blocks assembled in one shaft
- 6 No symbol-Full ball type
- 7 Symbol of clearance : No symbol-Normal preload / G<sub>1</sub>-Light preload / G<sub>2</sub>-Heavy preload / G<sub>s</sub>-Special preload (\*2)
- 8 Length of rail
- 9 Size of G value: standard G value has no symbol
- 10 No symbol-Rail counterbore type (top assembly)
- 11 Symbol of precision : No symbol-Moderate / H-High / P-Precision / SP-Super precision / UP-Ultra precision (\*3)
- 12 No symbol-Standard rail / E-special rail specification
- 13 Number of axes used in the same plane

(\*1) See Symbol List of Optional Parts at page 113. (\*2) See Radial Clearance at page 30.

(\*3) See Selection of Precision Class at page 32.

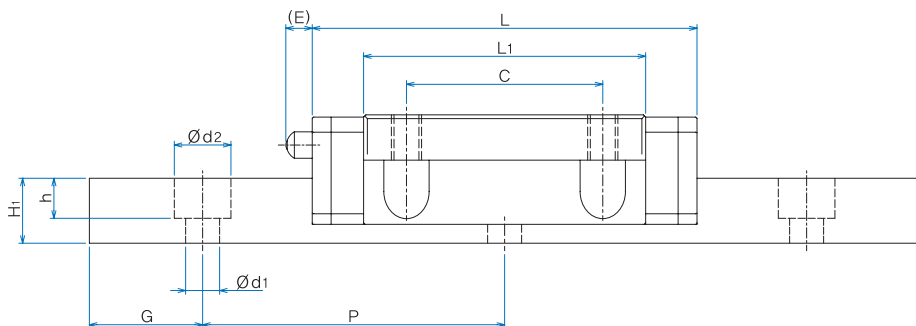

Unit: mm

Dimensions of rail							Basic load rating		Static allowance moment · N m					Mass	
Width W <sub>1</sub> 0 -0.05	W <sub>2</sub>	W <sub>3</sub>	Height H <sub>1</sub>	G	Pitch P	d <sub>1</sub> × d <sub>2</sub> × h	C N	C <sub>0</sub> N	M <sub>x</sub>		M <sub>y</sub>		M <sub>z</sub>	Block kg	Rail kg/m
									1 block	Double blocks	1 block	Double blocks			
33	13.5	18	8.6	15	40	4.5 × 7.5 × 5.3	7.3	12.2	0.081	0.381	0.081	0.381	0.205	0.15	1.9
37	15.5	22	11	15	50	4.5 × 7.5 × 5.3	8.4	14.8	0.119	0.547	0.119	0.547	0.278	0.24	2.9
42	19	24	15	20	60	4.5 × 7.5 × 5.3	15.3	24.8	0.239	1.114	0.239	1.114	0.527	0.47	4.5
69	25.5	40	19	20	80	7 × 11 × 9	33.9	53.2	0.773	3.528	0.773	3.528	1.851	1.40	9.6

1N ≈ 0.102kgf

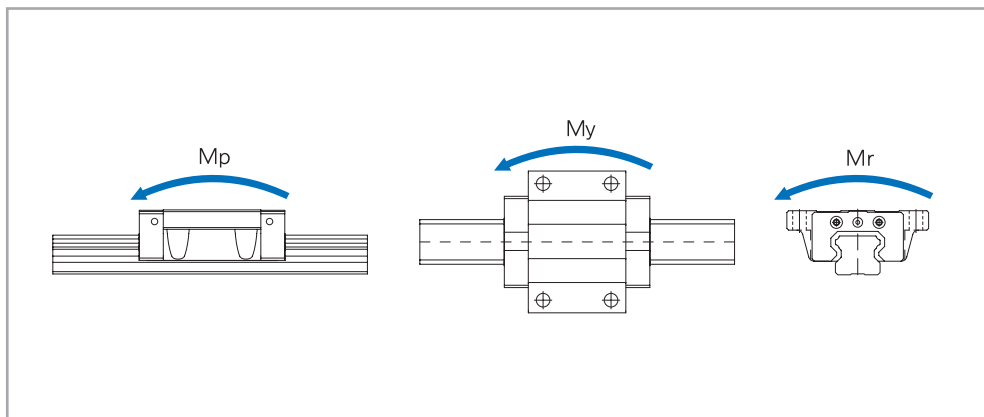

## HB-R Series

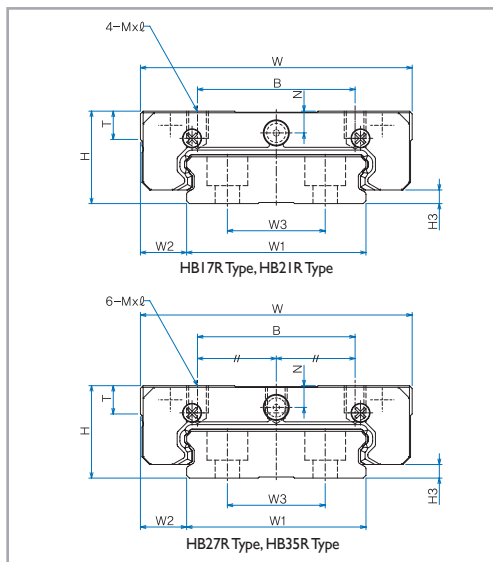
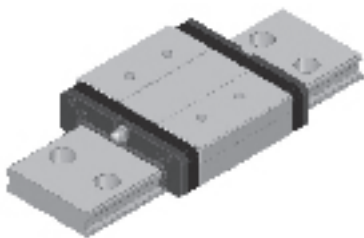

Model No.	External dimensions			Dimensions of block								Grease nipple	H <sub>3</sub>
	Height H	Width W	Length L	B	C	M X L	L <sub>i</sub>	T	N	E			
HB17R	17	50	51	29	15	M4 X 5	37.4	5.2	4	3.5	A-Ø3	2.5	
HB21R	21	54	59	31	19	M5 X 6	45.4	8	5	3.5	A-Ø3	3.3	
HB27R	27	62	72.5	46	32	M6 X 6	54.7	10	6	10.3	B-M6F	3.5	
HB35R	35	100	105.3	76	50	M8 X 8	82.1	14	7.6	10.3	B-M6F	4	

### Composition of Model Name & Number



- 1 Model No.
- 2 Type of block : F-Flange standard type / R-Rectangular standard type
- 3 No symbol-Standard block / E-Special block specification
- 4 Type of seal : No symbol-No seal / UU-End seal / SS-End seal+ Inside seal / ZZ-End seal+ Inside seal+ Metal scraper / UULF-End seal+ LF seal / SSLF-End seal+ Inside seal+ LF seal / ZZLF-End seal+ Inside seal+ Metal scraper+ LF seal (\*1)
- 5 Number of blocks assembled in one shaft
- 6 No symbol-Full ball type
- 7 Symbol of clearance : No symbol-Normal preload / G<sub>1</sub>-Light preload / G<sub>2</sub>-Heavy preload / G<sub>s</sub>-Special preload (\*2)
- 8 Length of rail
- 9 Size of G value: standard G value has no symbol
- 10 No symbol-Rail counterbore type (top assembly)
- 11 Symbol of precision : No symbol-Moderate / H-High / P-Precision / SP-Super precision / UP-Ultra precision (\*3)
- 12 No symbol-Standard rail / E-special rail specification
- 13 Number of axes used in the same plane

(\*1) See Symbol List of Optional Parts at page 113. (\*2) See Radial Clearance at page 30.

(\*3) See Selection of Precision Class at page 32.

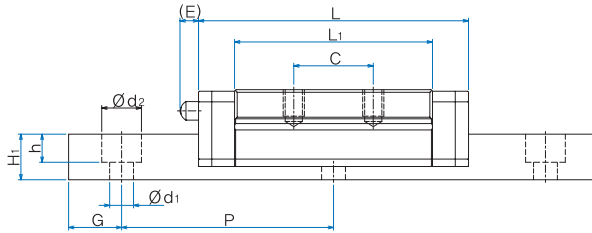

Unit: mm

Width W <sub>1</sub> 0 -0.05	Dimensions of rail						Basic load rating		Static allowance moment :N·m					Mass	
	W <sub>2</sub>	W <sub>3</sub>	Height H <sub>1</sub>	G	Pitch P	d <sub>1</sub> x d <sub>2</sub> x h	C :N	C <sub>0</sub> :N	M <sub>x</sub>		M <sub>y</sub>		M <sub>z</sub>	Block kg	Rail kg/m
									I block	Double blocks	I block	Double blocks	I block		
33	8.5	18	8.6	15	40	4.5x7.5x5.3	7.3	12.2	0.081	0.381	0.081	0.381	0.205	0.13	1.9
37	8.5	22	11	15	50	4.5x7.5x5.3	8.4	14.8	0.119	0.547	0.119	0.547	0.278	0.19	2.9
42	10	24	15	20	60	4.5x7.5x5.3	15.3	24.8	0.239	1.114	0.239	1.114	0.527	0.36	4.5
69	15.5	40	19	20	80	7x11x9	33.9	53.2	0.773	3.528	0.773	3.528	1.851	1.20	9.6

1N ≈ 0.102kgf

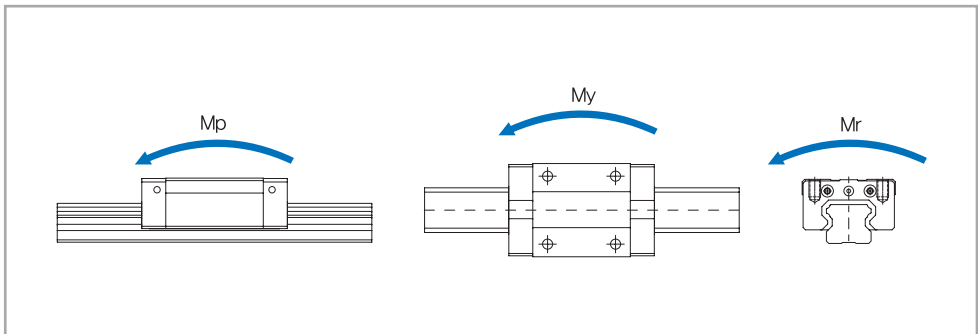

## 4. Slim Linear Motion Guide S Series

### 1) Structure of S Series

Linear Motion Guide S Series has a four-row circular arc-groove structure and a 4-direction equal load type. It also has an auto-adjusting face-to-face D/F structure. Using a ball as a rolling element, the model is a slim-type guide with a low sectional height, high rigidity and less noise.

### 2) Features of S Series

- a. High quality, high precision, and elimination of labor.
- b. High rigidity and high precision for implementing stable travel precision for a long time.
- c. Excellent wear resistance and friction resistance that ensure a long life.
- d. The face-to-face duplex structure just like the D/F combination of ball bearing, excellent at auto-adjusting and error-absorbing.
- e. Various specifications for easy design.
- f. Easy to use due to high compatibility of rail and block.
- g. 4-direction equal load and high-rigidity structure.
- h. A slim shape suitable for horizontal motion, ensuring stable running.

## 5. Slim Spacer Chain Linear Motion Guide S...S Series

### 1) Structure of S...S Series

Like S Series, Linear Motion Guide S...S Series has the 4-direction equal load type and auto-adjusting face-to-face D/F structure. It uses a ball as a rolling element and has a spacer between balls to prevent them from colliding each other in rolling motion. Since it makes less noise and more stable circulating motion than a full-ball type, it is possible to implement quiet running at high speed. In addition, the spacer can serve as a pocket of a lubricant.

### 2) Features of S...S Series

- a. As a spacer-incorporated type that improves frictional properties and prevents the collision of balls, the model not only allows stable circulating motion and smooth running but also reduces noise.
- b. Since a resin spacer is applied to the model, it is possible to prevent the collision of balls and the loss of oil film, and to generate less particles and dust.
- c. High quality, high precision, and elimination of labor.
- d. High rigidity and high precision for implementing stable travel precision for a long time.
- e. Excellent wear resistance and friction resistance that ensure a long life.
- f. The face-to-face duplex structure just like the D/F combination of ball bearing, excellent at auto-adjusting and error-absorbing.
- g. Various specifications for easy design.
- h. Easy to use due to high compatibility of rail and block.

Slim Linear Motion Guide S,S...S Series

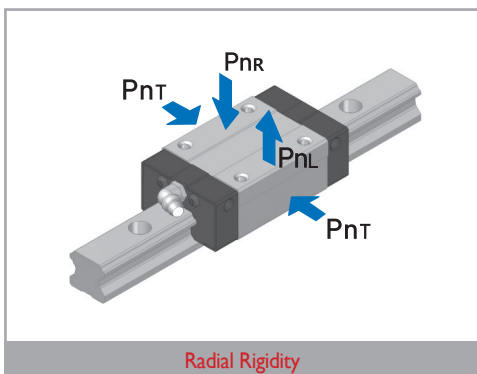
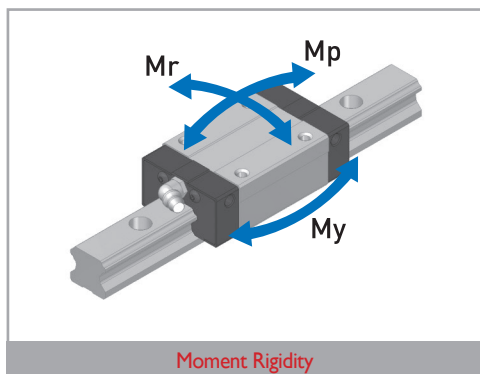
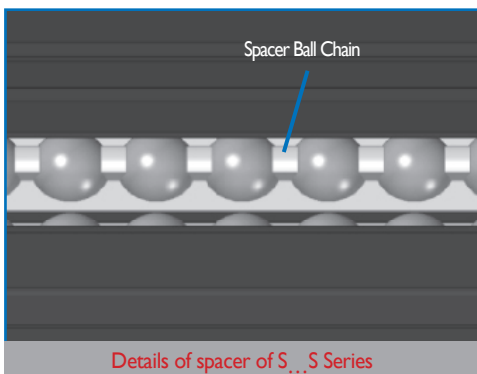
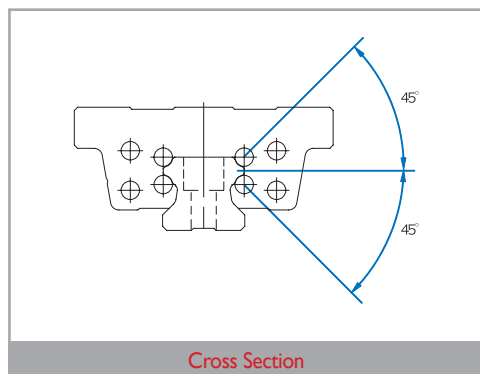
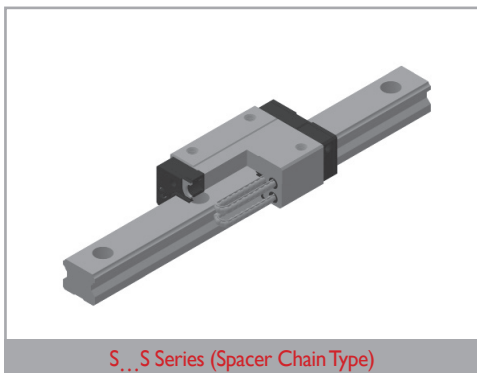
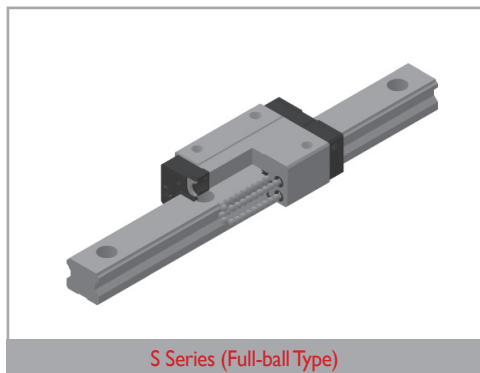

Types and Features

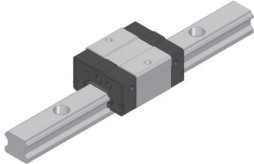
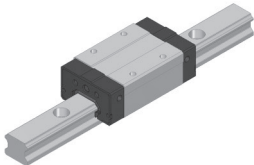
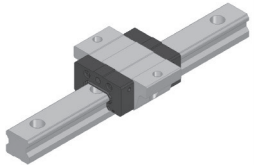
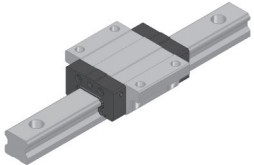
Category	Type	Shape & Feature	
Compact type	S-RC S-RC...S		<ul style="list-style-type: none"> <li>•A slim type with the tap-processed top of a block, minimizing the width(W) and height(H) of a block</li> <li>•4-row circular structure and 4-direction equal load type with 45° contact angle</li> </ul> <p>S Series are types with a spacer retainer helping to reduce ball-to-ball friction and generate less noise and dust</p>
	S-RN S-RN...S		<ul style="list-style-type: none"> <li>•The same cross section as in S-RC Series; a slim type with the increased load rating by enlarging the entire length (L1) of a block</li> <li>•4-row circular structure and 4-direction equal load type with 45° contact angle</li> </ul> <p>S Series are types with a spacer retainer helping to reduce ball-to-ball friction and generate less noise and dust</p>
Flange type	S-FC S-FC...S		<ul style="list-style-type: none"> <li>•A slim type with the tap-processed top of a block, minimizing the width(W) and height(H) of a block</li> <li>•4-row circular structure and 4-direction equal load type with 45° contact angle</li> </ul> <p>S Series are types with a spacer retainer helping to reduce ball-to-ball friction and generate less noise and dust</p>
	S-FN S-FN...S		<ul style="list-style-type: none"> <li>•The same cross section as in S-RC Series; a slim type with the increased load rating by enlarging the entire length (L1) of a block</li> <li>•4-row circular structure and 4-direction equal load type with 45° contact angle</li> </ul> <p>S Series are types with a spacer retainer helping to reduce ball-to-ball friction and generate less noise and dust</p>

Cartesian coordinated robot  
Linear actuator  
Automation system  
Semiconductor & display manufacturing system  
LED inspection equipment  
Dispenser equipment  
Medical Equipment  
High-speed transport system  
Woodworking machine  
Take-out robot  
Small machine tool  
Laser processor  
Precision measurement equipment

Standard and maximum lengths of rail

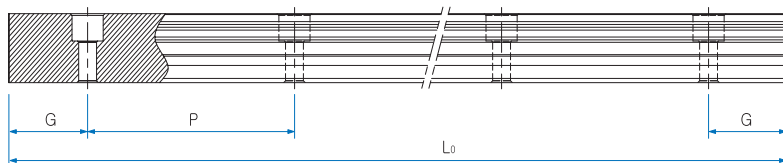

Unit: mm

Model No.	S15	S20	S25
Standard length	160	160	220
	220	220	280
	280	280	340
	⋮	340	400
	1360	⋮	460
	1480	1960	⋮
	1600	2080	2200
		2200	2320
		2440	
Standard pitch P	60	60	60
G	20	20	20
Max. length		4000	

Standard tap hole type of rail

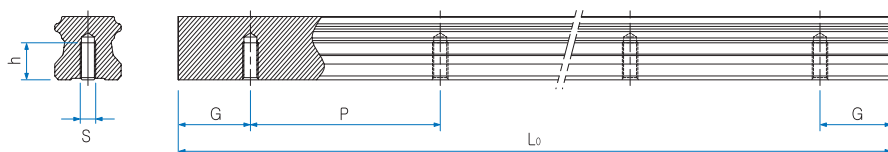

Model No.	S	h(mm)
S15	M5	8
S20	M6	10
S25	M6	12



## S-RC Series, S-RN Series

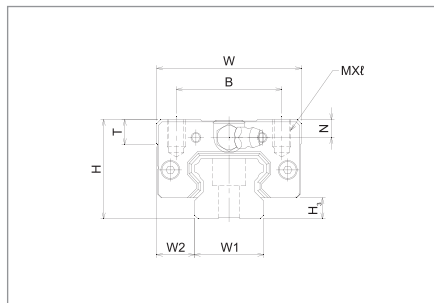
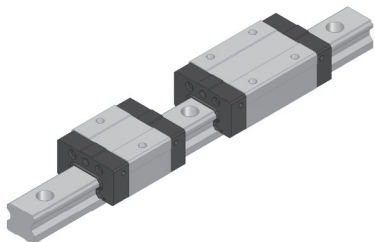

Model No.	External dimensions			Dimensions of block										Grease nipple	H <sub>3</sub>
	Height H	Width W	Length L	B	C	Mxℓ	L <sub>1</sub>	T	N	E	f	e	D		
S15RC	24	34	39.8	26	-	M4x6	24.0	6	6	4.7	3.7	3.25	3.3	A-M5	4.5
S15RN			56.5		26		40.7								
S20RC	28	42	47.8	32	-	M5x7	27.6	7.5	5.5	10.7	4.7	4.25	3.3	B-M6F	6
S20RN			66.8		32		46.7								
S25RC	33	48	59.4	35	-	M6x8	34.4	8	6	10.2	5	5	3.3	B-M6F	7
S25RN			83.2		35		58.2								

### Composition of Model Name & Number

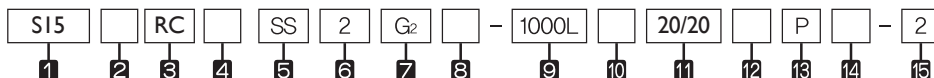

- 1** Model No.
- 2** Material of block : **No symbol**–Standard material / **M**–Stainless
- 3** Type of block : **RC**–Rectangular short type / **RN**–Rectangular standard type / **FC**–Flange short type/ **FN**–Flange standard type
- 4** **No symbol**–Standard block / **E**–Special block specification
- 5** Type of seal : **No symbol**–No seal / **UU**–End seal / **SS**–End seal+Side seal+Inner seal / **DD**–Double seal+Side seal+Inner seal / **ZZ**–End seal+Side seal+Inner seal+Metal scraper / **KK**–Double seal+Side seal+Inner seal+Metal scraper / **UULF**–End seal+LF seal / **SSLF**–End seal+Side seal+Inner seal+LF seal / **DDLFL**–Double seal+Side seal+Inner seal+LF seal / **ZZLFL**–End seal+Side seal+Inner seal+Metal scraper+LF seal / **KKLFL**–Double seal+Side seal+Inner seal+Metal scraper+LF seal **(#1)**
- 6** Number of blocks assembled in one shaft
- 7** Symbol of clearance : **No symbol**–Normal preload / **G<sub>1</sub>**–Light preload / **G<sub>2</sub>**–Heavy preload / **G<sub>s</sub>**–Special preload **(#2)**
- 8** Material of end plate : **No symbol** – Standard material / **I** – Stainless / **N** – Aluminum
- 9** Length of rail
- 10** Material of rail : **No symbol**–Standard material / **M**–Stainless
- 11** Size of G value: standard G value has no symbol
- 12** **No symbol**–Rail counterbore type (top assembly) / **A**–Rail tap hole type (bottom assembly) **(#3)**
- 13** Symbol of precision : **No symbol**–Moderate / **H**–High / **P**–Precision / **SP**–Super precision / **UP**–Ultra precision **(#4)**
- 14** **No symbol**–Standard rail / **E**–special rail specification
- 15** Number of axes used in the same plane

**(#1)** See Symbol List of Optional Parts at page 113. **(#2)** See Radial Clearance at page 30.

**(#3)** See Standard Tap Hole Type of Rail at page 79. **(#4)** See Selection of Precision Class at page 32.

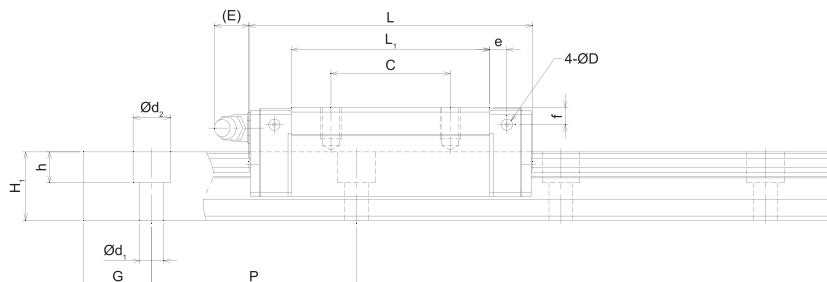

Unit : mm

Width $W_1$ $\pm 0.05$	Dimensions of rail					Basic load rating		Static allowance moment : N m					Mass	
	$W_2$	Height $H_1$	G	Pitch P	$d_1 \times d_2 \times h$	C iN	C <sub>0</sub> iN	$M_p$		$M_y$		$M_r$	Block kg	Rail kg/m
								l block	Double blocks	l block	Double blocks			
15	9.5	13	20	60	4.5x7.5x5.3	9.0	10	0.042	0.224	0.042	0.224	0.079	0.096	1.3
						12.6	16.2	0.115	0.552	0.115	0.552	0.129	0.156	
20	11	16.5	20	60	6x9.5x8.5	12.0	13.1	0.063	0.342	0.063	0.342	0.137	0.153	2.2
						16.8	21.2	0.173	0.838	0.173	0.838	0.223	0.246	
23	12.5	20	20	60	7x11x9	19.2	20.4	0.123	0.670	0.123	0.670	0.246	0.254	3.0
						27.0	33.1	0.337	1.636	0.337	1.636	0.398	0.413	

1N  $\approx$  0.102kgf

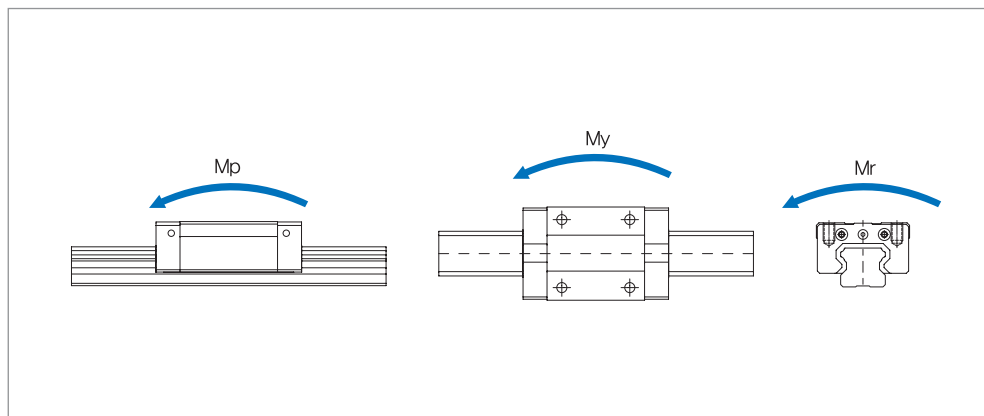

## S-FC Series, S-FN Series

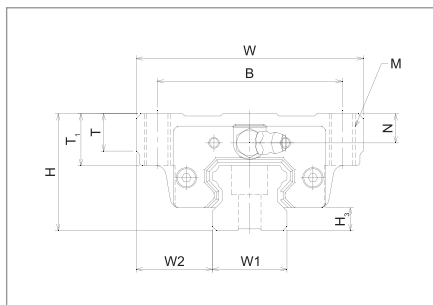
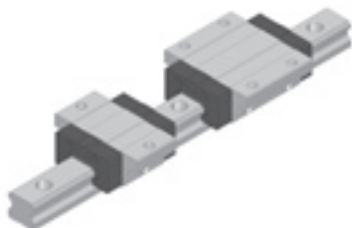

Model No.	External dimensions			Dimensions of block													Grease nipple	H <sub>3</sub>
	Height H	Width W	Length L	B	C	M	L <sub>1</sub>	T	T <sub>1</sub>	N	E	f	e	D				
S15FC	24	52	39.8	41	-	M5	24.0	6	7	6	4.7	3.7	3.25	3.3	A-M5	4.5		
S15FN			56.5		26		40.7											
S20FC	28	59	47.8	49	-	M6	27.6	8	9	5.5	10.7	4.7	4.25	3.3	B-M6F	6		
S20FN			66.8		32		46.7											
S25FC	33	73	59.4	60	-	M8	34.4	9	10	6	10.2	5	5	3.3	B-M6F	7		
S25FN			83.2		35		58.2											

### Composition of Model Name & Number

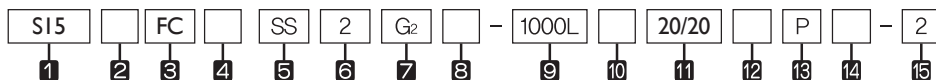

- 1 Model No.
- 2 Material of block : **No symbol**–Standard material / **M**–Stainless
- 3 Type of block : **RC**–Rectangular short type / **RN**–Rectangular standard type / **FC**–Flange short type/ **FN**–Flange standard type
- 4 **No symbol**–Standard block / **E**–Special block specification
- 5 Type of seal : **No symbol**–No seal / **UU**–End seal / **SS**–End seal+Side seal+Inner seal / **DD**–Double seal+Side seal+Inner seal / **ZZ**–End seal+Side seal+Inner seal+Metal scraper / **KK**–Double seal+Side seal+Inner seal+Metal scraper / **UULF**–End seal+LF seal / **SSLF**–End seal+Side seal+Inner seal+LF seal / **DDLFL**–Double seal+Side seal+Inner seal+LF seal / **ZZLF**–End seal+Side seal+Inner seal+Metal scraper+LF seal / **KKLF**–Double seal+Side seal+Inner seal+Metal scraper+LF seal (\*1)
- 6 Number of blocks assembled in one shaft
- 7 Symbol of clearance : **No symbol**–Normal preload / **G1**–Light preload / **G2**–Heavy preload / **Gs**–Special preload (\*2)
- 8 Material of end plate : **No symbol** - Standard material / **I** - Stainless / **N** - Aluminum
- 9 Length of rail
- 10 Material of rail : **No symbol**–Standard material / **M**–Stainless
- 11 Size of G value: standard G value has no symbol
- 12 **No symbol**–Rail counterbore type (top assembly) / **A**–Rail tap hole type (bottom assembly) (\*3)
- 13 Symbol of precision : **No symbol**–Moderate / **H**–High / **P**–Precision / **SP**–Super precision / **UP**–Ultra precision (\*4)
- 14 **No symbol**–Standard rail / **E**–special rail specification
- 15 Number of axes used in the same plane

(\*1) See Symbol List of Optional Parts at page 113. (\*2) See Radial Clearance at page 30.

(\*3) See Standard Tap Hole Type of Rail at page 79. (\*4) See Selection of Precision Class at page 32.

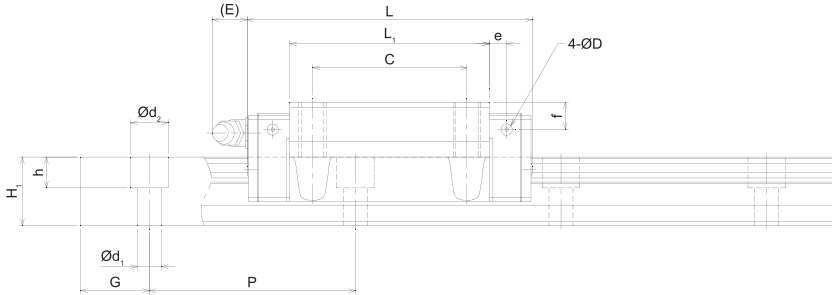

Unit: mm

Width $W_1$ $\pm 0.05$	Dimensions of rail					Basic load rating		Static allowance moment :N m					Mass	
	$W_2$	Height $H_1$	G	Pitch P	$d_1 \times d_2 \times h$	C iN	$C_0$ iN	$M_x$		$M_y$		$M_z$	Block kg	Rail kg/m
								1 block	Double blocks	1 block	Double blocks			
15	18.5	13	20	60	4.5x7.5x5.3	9.0	10	0.042	0.224	0.042	0.224	0.079	0.125	1.3
						12.6	16.2	0.115	0.552	0.115	0.552	0.129	0.203	
20	19.5	16.5	20	60	6x9.5x8.5	12.0	13.1	0.063	0.342	0.063	0.342	0.137	0.187	2.2
						16.8	21.2	0.173	0.838	0.173	0.838	0.223	0.301	
23	25.0	20	20	60	7x11x9	19.2	20.4	0.123	0.670	0.123	0.670	0.246	0.320	3.0
						27.0	33.1	0.337	1.636	0.337	0.163	0.398	0.527	

1N  $\approx$  0.102kgf

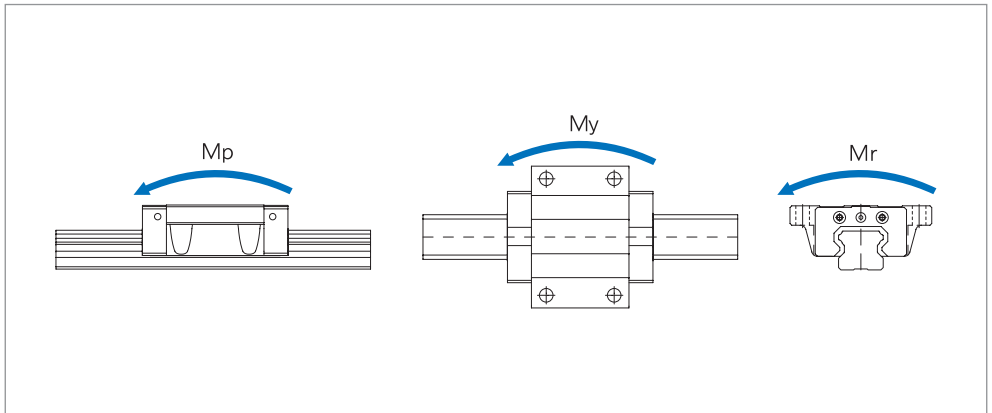

## S-RC...S Series, S-RN...S Series

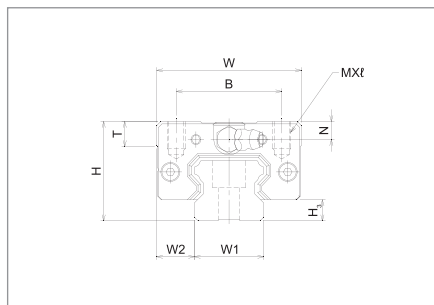
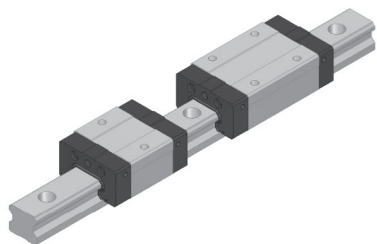

Model No.	External dimensions			DIMENSIONS OF BLOCK													H <sub>3</sub>
	Height H	Width W	Length L	B	C	M×l	L <sub>i</sub>	T	N	E	f	e	D	Grease nipple			
S15RC...S	24	34	39.8	26	-	M4x6	24.0	6	6	4.7	3.7	3.25	3.3	A-M5	4.5		
S15RN...S			56.5		26		40.7										
S20RC...S	28	42	47.8	32	-	M5x7	27.6	7.5	5.5	10.7	4.7	4.25	3.3	B-M6F	6		
S20RN...S			66.8		32		46.7										
S25RC...S	33	48	59.4	35	-	M6x9	34.4	8	6	10.2	5	5	3.3	B-M6F	7		
S25RN...S			83.2		35		58.2										

### Composition of Model Name & Number



- 1 Model No.
- 2 Material of block : **No symbol**–Standard material / **M**–Stainless
- 3 Type of block : **RC**–Rectangular short type / **RN**–Rectangular standard type / **FC**–Flange short type/ **FN**–Flange standard type
- 4 **No symbol**–Standard block / **E**–Special block specification
- 5 Type of seal : **No symbol**–No seal / **UU**–End seal / **SS**–End seal+Side seal+Inner seal / **DD**–Double seal+Side seal+Inner seal / **ZZ**–End seal+Side seal+Inner seal+Metal scraper / **KK**–Double seal+Side seal+Inner seal+Metal scraper / **UULF**–End seal+LF seal / **SSLF**–End seal+Side seal+Inner seal+LF seal / **DDLFL**–Double seal+Side seal+Inner seal+LF seal / **ZZLFL**–End seal+Side seal+Inner seal+Metal scraper+LF seal / **KKLFL**–Double seal+Side seal+Inner seal+Metal scraper+LF seal <sup>(\*)1</sup>
- 6 Number of blocks assembled in one shaft
- 7 **S**–Spacer chain type
- 8 Symbol of clearance : **No symbol**–Normal preload / **G<sub>1</sub>**–Light preload / **G<sub>2</sub>**–Heavy preload / **G<sub>s</sub>**–Special preload <sup>(\*)2</sup>
- 9 Material of end plate : **No symbol** - Standard material / **I** - Stainless / **N** - Aluminum
- 10 Length of rail
- 11 Material of rail : **No symbol**–Standard material / **M**–Stainless
- 12 Size of G value: standard G value has no symbol
- 13 **No symbol**–Rail counterbore type (top assembly) / **A**–Rail tap hole type (bottom assembly) <sup>(\*)3</sup>
- 14 Symbol of precision : **No symbol**–Moderate / **H**–High / **P**–Precision / **SP**–Super precision / **UP**–Ultra precision <sup>(\*)4</sup>
- 15 **No symbol**–Standard rail / **E**–special rail specification
- 16 Number of axes used in the same plane

<sup>(\*)1</sup> See Symbol List of Optional Parts at page 113. <sup>(\*)2</sup> See Radial Clearance at page 30.

<sup>(\*)3</sup> See Standard Tap Hole Type of Rail at page 79. <sup>(\*)4</sup> See Selection of Precision Class at page 32.

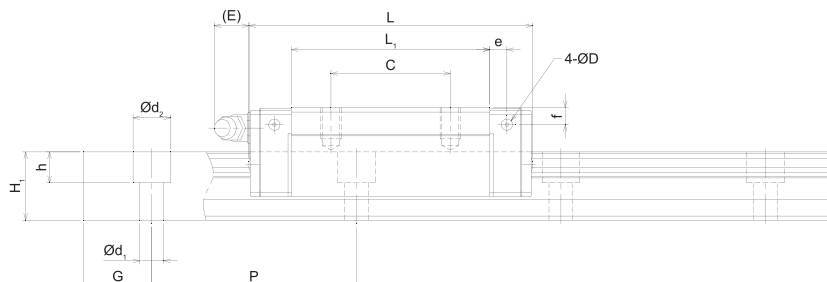

Unit: mm

Dimensions of rail						Basic load rating		Static allowance moment $\cdot$ N $\cdot$ m						Mass	
WIDTH $W_1$ $\pm 0.05$	$W_2$	Height $H_1$	G	Pitch P	$d_1 \times d_2 \times h$	C $\cdot$ N	$C_0$ $\cdot$ N	$M_x$		$M_y$		$M_z$		Block kg	Rail kg/m
								1 block	Double blocks	1 block	Double blocks	1 block	Double blocks		
15	9.5	13	20	60	4.5x7.5x5.3	8.3	10	0.042	0.224	0.042	0.224	0.079	0.096	1.3	
						12.1	16.2	0.115	0.552	0.115	0.552	0.129	0.156		
20	11	16.5	20	60	6x9.5x8.5	11.1	13.1	0.063	0.342	0.063	0.342	0.137	0.153	2.2	
						16.1	21.2	0.173	0.838	0.173	0.838	0.223	0.246		
23	12.5	20	20	60	7x11x9	17.9	20.4	0.123	0.670	0.123	0.670	0.246	0.254	3.0	
						25.8	33.1	0.337	1.636	0.337	1.636	0.398	0.413		

1N  $\approx$  0.102kgf

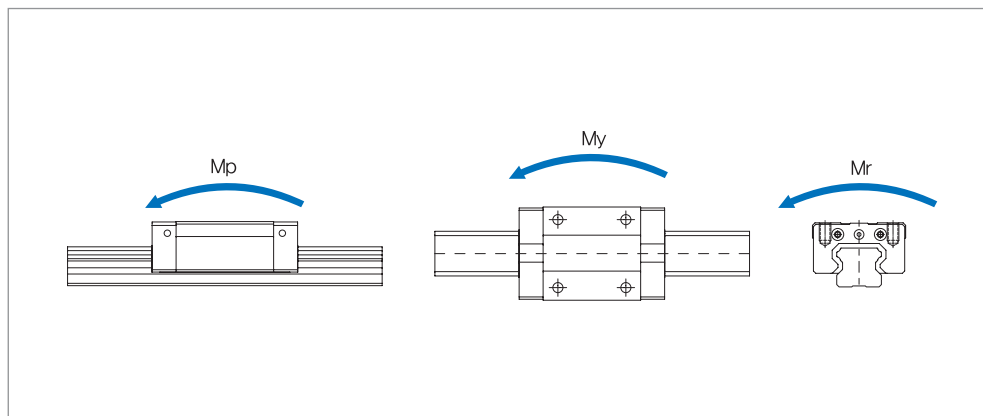

## S-FC...S Series, S-FN...S Series

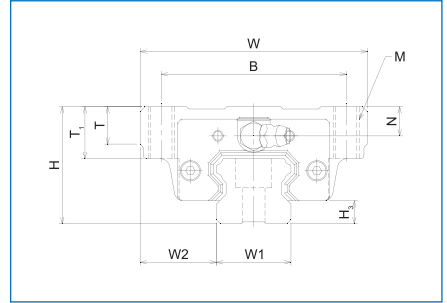
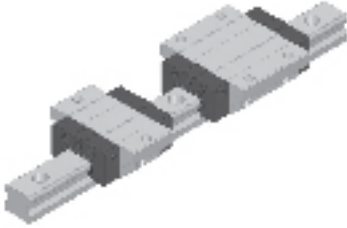

Model No.	External dimensions			Dimensions of block														Grease nipple	H <sub>3</sub>
	HEIGHT H	WIDTH W	LENGTH L	B	C	M	L <sub>i</sub>	T	T <sub>1</sub>	N	E	f	e	D					
S15FC...S	24	52	39.8	41	-	M5	24.0	6	7	6	4.7	3.7	3.25	3.3	A-M5	4.5			
S15FN...S			56.5		26		40.7												
S20FC...S	28	59	47.8	49	-	M6	27.6	8	9	5.5	10.7	4.7	4.25	3.3	B-M6F	6			
S20FN...S			66.8		32		46.7												
S25FC...S	33	73	59.4	60	-	M8	34.4	9	10	6	10.2	5	5	3.3	B-M6F	7			
S25FN...S			83.2		35		58.2												

### Composition of Model Name & Number

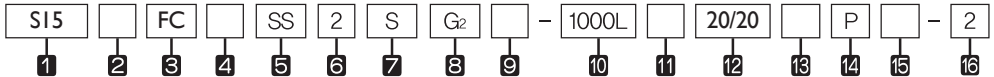

- 1 Model No.
- 2 Material of block: **No symbol**–Standard material / **M**–Stainless
- 3 Type of block: **RC**–Rectangular short type / **RN**–Rectangular standard type / **FC**–Flange short type/ **FN**–Flange standard type
- 4 **No symbol**–Standard block / **E**–Special block specification
- 5 Type of seal: **No symbol**–No seal / **UU**–End seal / **SS**–End seal+Side seal+Inner seal / **DD**–Double seal+Side seal+Inner seal / **ZZ**–End seal+Side seal+Inner seal+Metal scraper / **KK**–Double seal+Side seal+Inner seal+Metal scraper / **UULF**–End seal+LF seal / **SSLF**–End seal+Side seal+Inner seal+LF seal / **DDLf**–Double seal+Side seal+Inner seal+LF seal / **ZZLF**–End seal+Side seal+Inner seal+Metal scraper+LF seal / **KKLF**–Double seal+Side seal+Inner seal+Metal scraper+LF seal (\*1)
- 6 Number of blocks assembled in one shafted in one shaft
- 7 **S**–Spacer chain type
- 8 Symbol of clearance: **No symbol**–Normal preload / **G<sub>1</sub>**–Light preload / **G<sub>2</sub>**–Heavy preload / **G<sub>s</sub>**–Special preload (\*2)
- 9 Material of end plate: **No symbol** - Standard material / **I** - Stainless / **N** - Aluminum
- 10 Length of rail
- 11 Material of rail: **No symbol**–Standard material / **M**–Stainless
- 12 Size of G value: standard G value has no symbol
- 13 **No symbol**–Rail counterbore type (top assembly) / **A**–Rail tap hole type (bottom assembly) (\*3)
- 14 Symbol of precision: **No symbol**–Moderate / **H**–High / **P**–Precision / **SP**–Super precision / **UP**–Ultra precision (\*4)
- 15 **No symbol**–Standard rail / **E**–special rail specification
- 16 Number of axes used in the same plane

(\*1) See Symbol List of Optional Parts at page 113. (\*2) See Radial Clearance at page 30.

(\*3) See Standard Tap Hole Type of Rail at page 79. (\*4) See Selection of Precision Class at page 32.

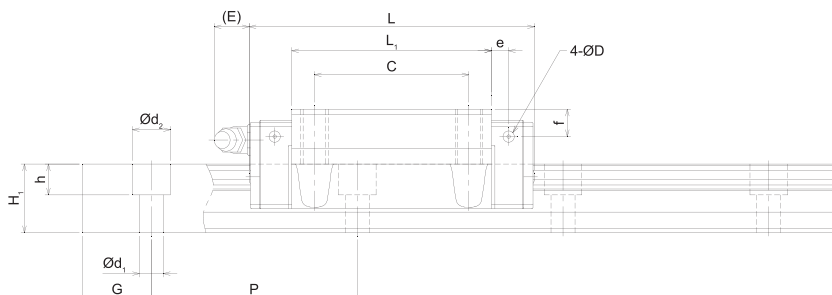

Unit: mm

Dimensions of rail						Basic load rating		Static allowance moment -N m					Mass	
WIDTH W <sub>1</sub> ±0.05	W <sub>2</sub>	Height H <sub>1</sub>	G	Pitch P	d <sub>1</sub> x d <sub>2</sub> x h	C i/N	C <sub>0</sub> i/N	M <sub>x</sub>		M <sub>y</sub>		M <sub>z</sub>	Block kg	Rail kg/m
								1 block	Double blocks	1 block	Double blocks	1 block		
15	18.5	13	20	60	4.5x7.5x5.3	8.3	10	0.042	0.224	0.042	0.224	0.079	0.125	1.3
						12.1	16.2	0.115	0.552	0.115	0.552	0.129	0.203	
20	19.5	16.5	20	60	6x9.5x8.5	11.1	13.1	0.063	0.342	0.063	0.342	0.137	0.187	2.2
						16.1	21.2	0.173	0.838	0.173	0.838	0.223	0.301	
23	25.0	20	20	60	7x11x9	17.9	20.4	0.123	0.670	0.123	0.670	0.246	0.320	3.0
						25.8	33.1	0.337	1.636	0.337	1.636	0.398	0.527	

1N ≈ 0.102kgf

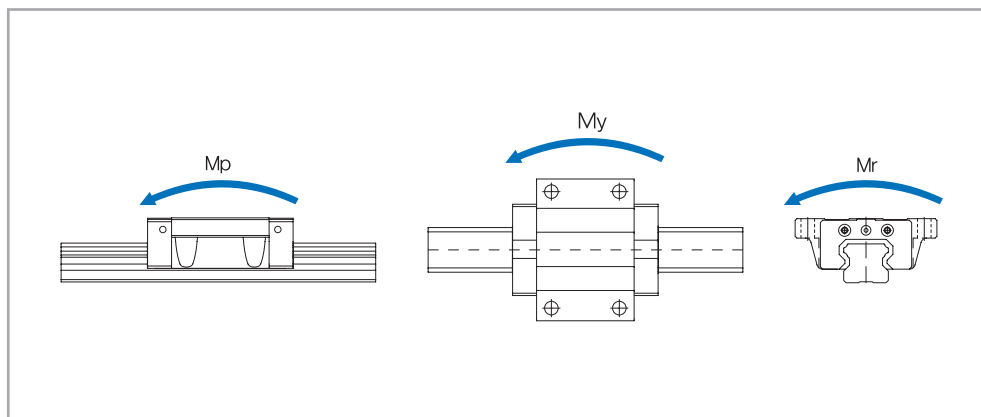



## 6. Slim Linear Motion Guide HS, HS...S Series

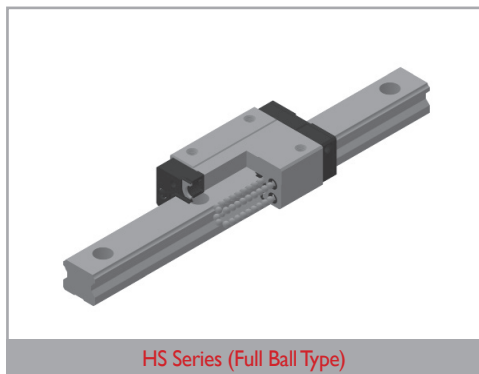

HS Series (Full Ball Type)

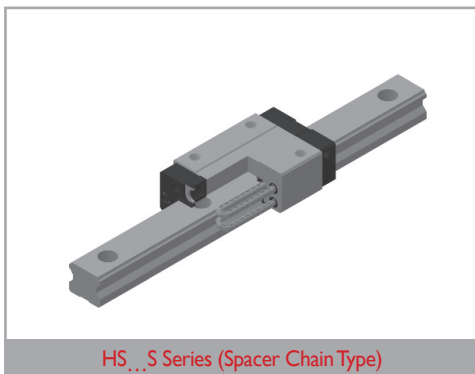

HS...S Series (Spacer Chain Type)

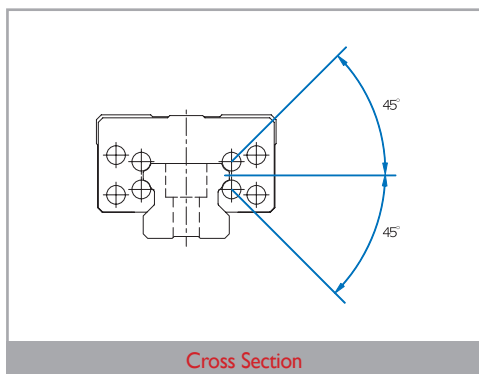

Cross Section

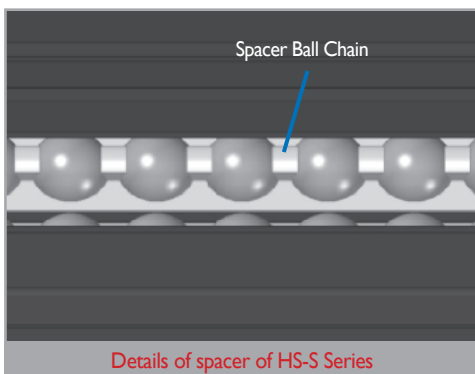

Details of spacer of HS-S Series

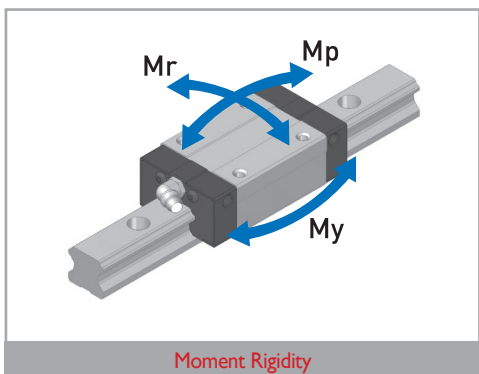

Moment Rigidity

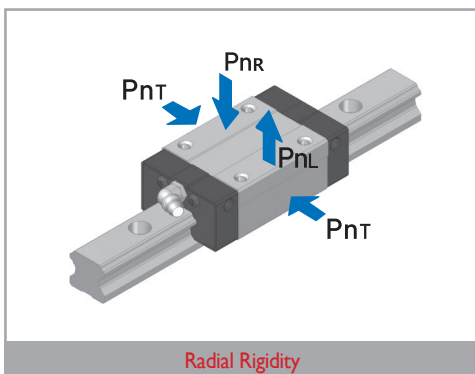

Radial Rigidity

Standard and maximum lengths of rail

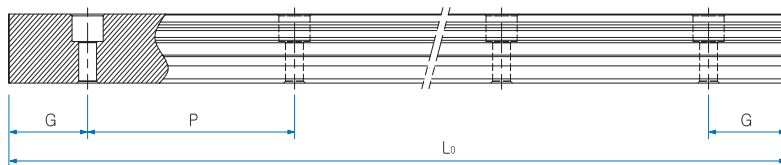

Unit: mm

Model No.	HS25	HS30	HS35	HS45	HS55
Standard length	220	280	440	570	780
	340	360	520	675	900
	400	440	600	780	1020
	⋮	520	760	885	⋮
	2200	⋮	840	⋮	2820
	2320	2520	⋮	2880	2940
	2440	2680	2840	2985	3060
Standard pitch P		2840	2920	3090	
			3000		
G	60	80	80	10.5	120
Max. length	20	20	20	22.5	30
			4000		

Standard tap hole type of rail

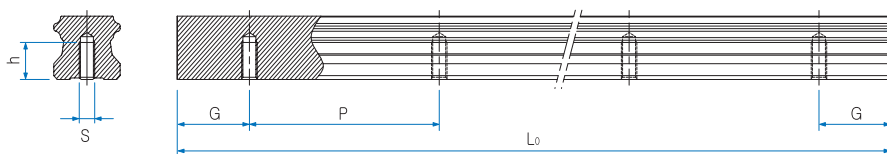

Model No.	S	h(mm)
HS25	M6	12
HS30	M8	15
HS35	M8	17
HS45	M12	24
HS55	M14	24

## HS-RN Series, HS-RL Series

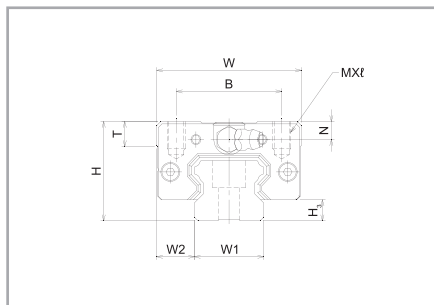
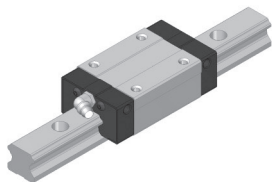

Model No.	External dimensions			Dimensions of block													H <sub>3</sub>
	Height H	Width W	Length L	B	C	Mxℓ	L <sub>i</sub>	T	N	E	f	e	D	Grease nipple			
HS25RN	36	48	83.2	35	35	M6x6.5	58.3	8	9	10.2	8	5	3.3	B-M6F	7		
HS25RL			103.1		50		78.2										
HS30RN	42	60	99.3	40	40	M8x8	70.8	8	8.2	9.8	5.9	5.8	5.2	B-M6F	7		
HS30RL			121.5		60		93										
HS35RN	48	70	111.8	50	50	M8x10	80.8	15	10	9.7	8.5	6.5	5.2	B-M6F	7.5		
HS35RL			137.2		72		106.2										

### Composition of Model Name & Number

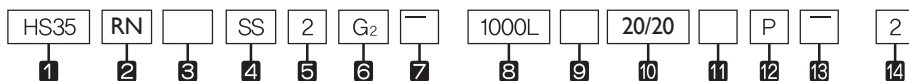

- 1 Model No.
- 2 Type of block : **RC**–Rectangular short type / **RN**–Rectangular standard type / **FC**–Flange short type/ **FN**–Flange standard type
- 3 **No symbol**–Standard block / **E**–Special block specification
- 4 Type of seal : **No symbol**–No seal / **UU**–End seal / **SS**–End seal+Side seal+Inner seal / **DD**–Double seal+Side seal+Inner seal / **ZZ**–End seal+Side seal+Inner seal+Metal scraper / **KK**–Double seal+Side seal+Inner seal+Metal scraper / **UULF**–End seal+LF seal / **SSLF**–End seal+Side seal+Inner seal+LF seal / **DDLFL**–Double seal+Side seal+Inner seal+LF seal / **ZZLFL**–End seal+Side seal+Inner seal+Metal scraper+LF seal / **KKLFL**–Double seal+Side seal+Inner seal+Metal scraper+LF seal (\*1)
- 6 Number of blocks assembled in one shaft
- 7 Symbol of clearance : **No symbol**–Normal preload / **G<sub>1</sub>**–Light preload / **G<sub>2</sub>**–Heavy preload / **G<sub>s</sub>**–Special preload (\*2)
- 8 Material of end plate : **No symbol** - Standard material / **I** - Stainless / **N** - Aluminum
- 9 Length of rail
- 10 Material of rail : **No symbol**–Standard material / **M**–Stainless
- 11 Size of G value: standard G value has no symbol
- 12 **No symbol**–Rail counterbore type (top assembly) / **A**–Rail tap hole type (bottom assembly) (\*3)
- 13 Symbol of precision : **No symbol**–Moderate / **H**–High / **P**–Precision / **SP**–Super precision / **UP**–Ultra precision (\*4)
- 14 **No symbol**–Standard rail / **E**–special rail specification

(\*1) See Symbol List of Optional Parts at page 113. (\*2) See Radial Clearance at page 30.

(\*3) See Standard Tap Hole Type of Rail at page 89. (\*4) See Selection of Precision Class at page 32.

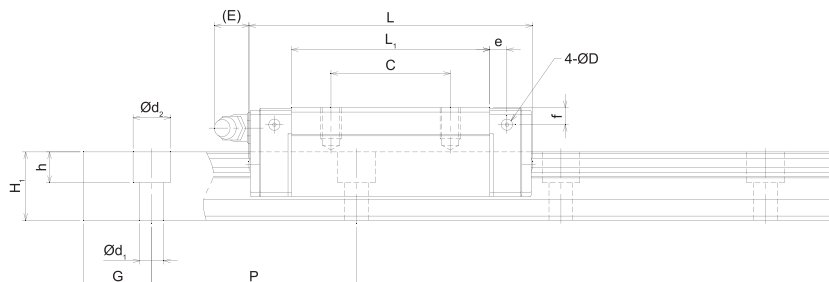

Unit: mm

Width $W_1$ $\pm 0.05$	Dimensions of rail					Basic load rating		Static allowance moment $\pm N \cdot m$					Mass	
	$W_2$	Height $H_1$	$G$	Pitch $P$	$d_1 \times d_2 \times h$	$C$ $\pm N$	$C_0$ $\pm N$	$M_L$		$M_T$		$M_V$	Block kg	Rail kg/m
								I block	Double blocks	I block	Double blocks			
23	12.5	20	20	60	7x11x9	27.0	33.1	0.337	1.636	0.337	1.636	0.398	0.53	3.0
								0.596	2.760	0.596	2.760	0.525	0.71	
28	16	25.1	20	80	9x14x14.1	50.4	57.1	0.711	3.384	0.711	3.384	0.828	0.9	4.85
								1.203	5.506	1.203	5.506	1.067	1.1	
34	18	27	20	80	9x14x13	67.0	74.6	1.062	5.012	1.062	5.012	1.298	1.5	6.58
								1.797	8.172	1.797	8.172	1.674	2.01	

$1N \approx 0.102kgf$

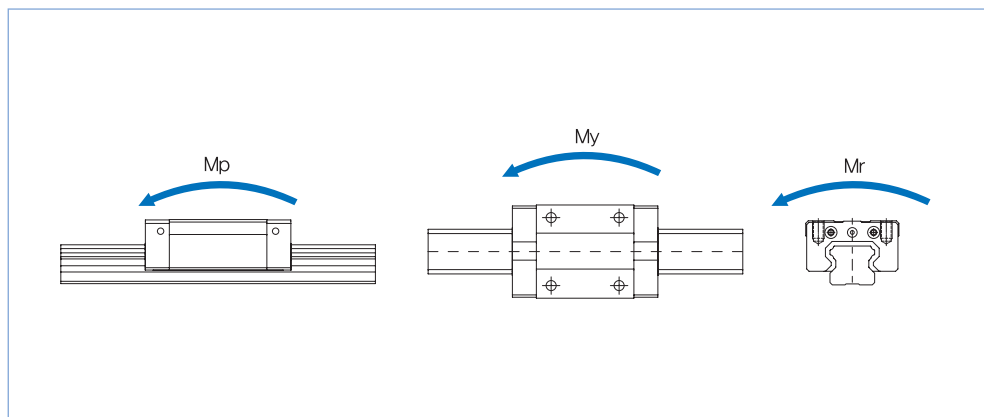

## HS-RN...S Series, HS-RL...S Series

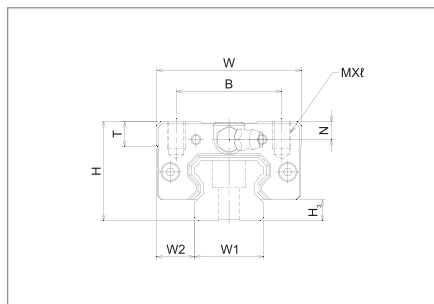
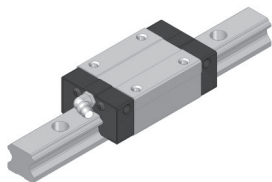

Model No.	External dimensions			Dimensions of block											Grease nipple	H <sub>3</sub>
	Height H	Width W	Length L	B	C	Mxℓ	L <sub>i</sub>	T	N	E	f	e	D			
HS25RN...S	36	48	83.2	35	35	M6x6.5	58.3	8	9	10.2	8	5	3.3	B-M6F	7	
HS25RL...S			103.1		50		78.2									
HS30RN...S	42	60	99.3	40	40	M8x8	70.8	8	8.2	9.8	5.9	5.8	5.2	B-M6F	7	
HS30RL...S			121.5		60		93									
HS35RN...S	48	70	111.8	50	50	M8x10	80.8	15	10	9.7	8.5	6.5	5.2	B-M6F	7.5	
HS35RL...S			137.2		72		106.2									

### Composition of Model Name & Number

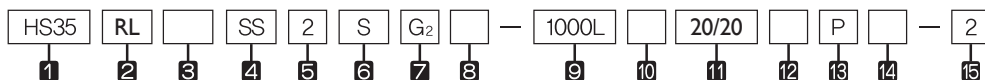

- 1 Model No.
- 2 Type of block : **RC**–Rectangular short type / **RN**–Rectangular standard type / **FC**–Flange short type/ **FN**–Flange standard type
- 3 **No symbol**–Standard block / **E**–Special block specification
- 4 Type of seal : **No symbol**–No seal / **UU**–End seal / **SS**–End seal+Side seal+Inner seal / **DD**–Double seal+Side seal+Inner seal / **ZZ**–End seal+Side seal+Inner seal+Metal scraper / **KK**–Double seal+Side seal+Inner seal+Metal scraper / **UULF**–End seal+LF seal / **SSLF**–End seal+Side seal+Inner seal+LF seal / **DDL**–Double seal+Side seal+Inner seal+LF seal / **ZZLF**–End seal+Side seal+Inner seal+Metal scraper+LF seal / **KKLF**–Double seal+Side seal+Inner seal+Metal scraper+LF seal (\*1)
- 5 Number of blocks assembled in one shaft
- 6 **No symbol**–Full ball type / **S**–Spacer chain type
- 7 Symbol of clearance : **No symbol**–Normal preload / **GI**–Light preload / **G<sub>2</sub>**–Heavy preload / **G<sub>s</sub>**–Special preload (\*2)
- 8 Material of end plate : **No symbol** - Standard material / **I** - Stainless / **N** - Aluminum
- 9 Length of rail
- 10 Material of rail : **No symbol**–Standard material / **M**–Stainless
- 11 Size of G value: standard G value has no symbol
- 12 **No symbol**–Rail counterbore type (top assembly) / **A**–Rail tap hole type (bottom assembly) (\*3)
- 13 Symbol of precision : **No symbol**–Moderate / **H**–High / **P**–Precision / **SP**–Super precision / **UP**–Ultra precision (\*4)
- 14 **No symbol**–Standard rail / **E**–special rail specification
- 15 Number of axes used in the same plane

(\*1) See Symbol List of Optional Parts at page 113. (\*2) See Radial Clearance at page 30.

(\*3) See Standard Tap Hole Type of Rail at page 89. (\*4) See Selection of Precision Class at page 32.

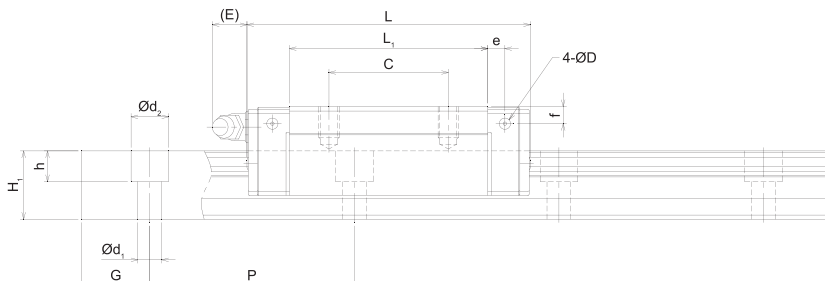

Unit: mm

Dimensions of rail						Basic load rating		Static allowance moment kN m					Mass	
Width W <sub>1</sub> ±0.05	W <sub>2</sub>	Height H <sub>1</sub>	G	Pitch P	d <sub>1</sub> x d <sub>2</sub> x h	C kN	C <sub>0</sub> kN	M <sub>p</sub>		M <sub>y</sub>		M <sub>r</sub>	Block kg	Rail kg/m
								1 block	Double blocks	1 block	Double blocks	1 block		
23	12.5	20	20	60	7x11x9	25.8	33.1	0.337	1.636	0.337	1.636	0.398	0.53	3.0
						31.7	43.6	0.596	2.760	0.596	2.760	0.525	0.71	
28	16	25.1	20	80	9x14x14.1	48.0	57.1	0.711	3.384	0.711	3.384	0.828	0.9	4.85
						58.0	73.6	1.203	5.506	1.203	5.506	1.067	1.1	
34	18	27	20	80	9x14x13	63.7	74.6	1.062	5.012	1.062	5.012	1.298	1.5	6.58
						77.1	96.2	1.797	8.172	1.797	8.172	1.674	2.01	

1N ≈ 0.102kgf

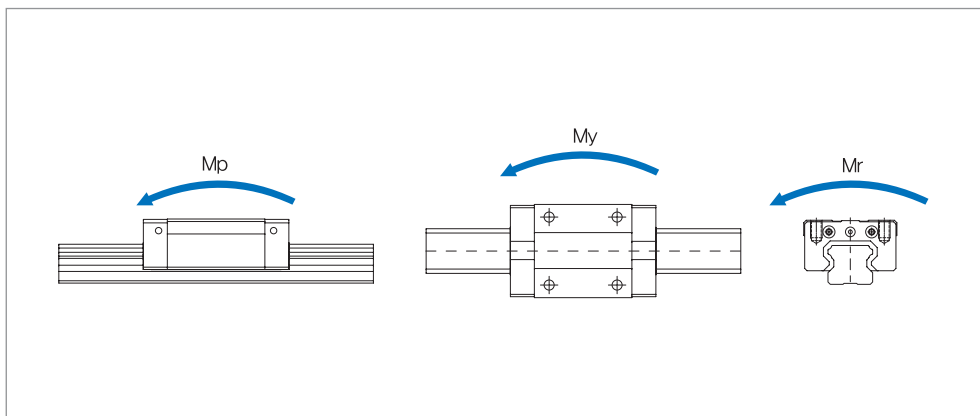

## 7. Miniature Linear Motion Guide M Series

### 1) Structure of M Series

WON Miniature Linear Motion Guide M Series has a shape of a gothic-arch groove in the raceway of a rail and a block and a 4-direction equal type structure with 2-row 4-point contact balls at 45 degree. This model, though small-sized, supports stable travel and high rigidity for variable load or complex load under which a direction or size changes.

### 2) Features of M Series

- a. A compact and highly-rigid 4-direction equal load type.
- b. A variety of specifications in consideration of space and load rating in order for easy design.
- c. It is convenient to maintain balls at the time of block-rail assembly, for a block has the wire to prevent ball separation built in.
- d. This model made of stainless steel is resistant for rust. Therefore, it is suitable in a rust-resistant environment or the cleanroom that inhibits generation of particles.

## 8. Wide Miniature Linear Motion Guide MB Series

### 1) Structure of MB Series

Like M Series, WON Miniature Linear Motion Guide MB Series has the 4-direction equal load type. As its rail and block get widened, the model improves basic load rating and moment load compared to M Series.

### 2) Features of MB Series

- a. Wide block and rail, an increased number of effective balls, and improved load rating and moment load.
- b. Wider than a general type of miniature linear motion guide, increased rigidity, and very favorable in the use of one axis.
- c. A compact and highly-rigid 4-direction equal load type.
- d. A variety of specifications in consideration of space and load rating in order for easy design.
- e. It is convenient to maintain balls during block-rail assembly, for a block has the wire to prevent ball separation.
- f. This model made of stainless steel is resistant for rust. Therefore, it is suitable in a rust-resistant environment or the cleanroom that inhibits generation of particles. (The bearing steel materials for MB 12 and MB 15 are reserved.)

## Miniature Linear Motion Guide M, MB Series

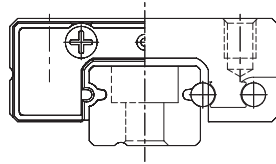
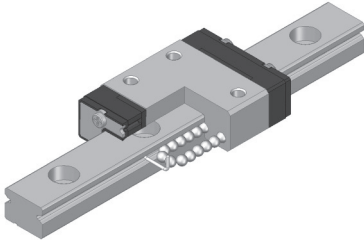

Standard M Series

Standard type

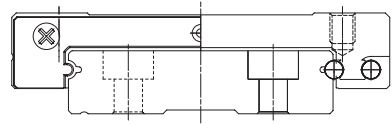
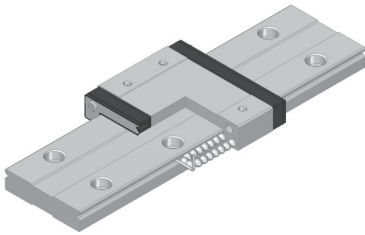

Wide MB Series

Wide type

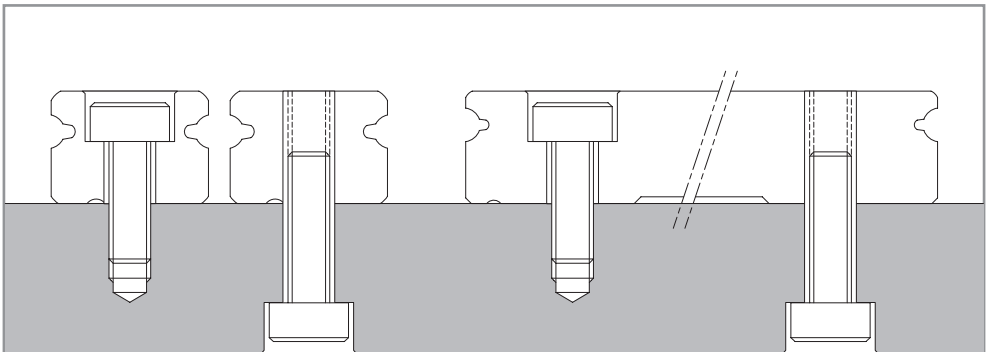

Bolt fastening

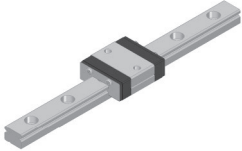
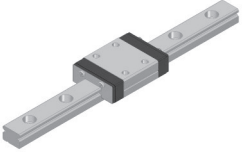
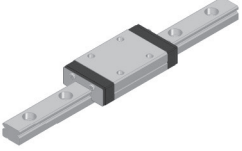
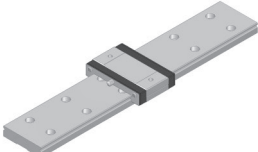
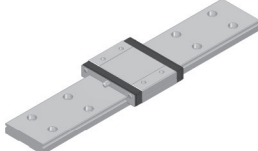
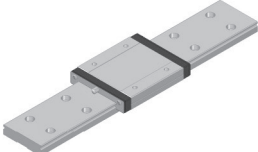

Types and Features

Category	Type	Shape & Feature	
Compact type	M-C		<p>Standard Type of Miniature Linear Motion Guide</p> <p>The bearing steel materials for M12 and M15 (MT12, MT15) are available</p>
	M-N		
	M-L		
Flange type	MB-C MBTC		<p>Wider block (W) and longer total length (L1) than M Series; highly-rigid and wide type with improved load rating and allowance moment</p> <p>The bearing steel materials for MB12 and MB15 (MBT12, MBT15) are available</p>
	MB-N MBTN		
	MB-L MBTL		
		<p>Semiconductor inspection equipment</p> <p>Semiconductor assembly equipment</p> <p>Display inspection</p> <p>Head-axis</p> <p>LED inspection equipment</p> <p>Pneumatic machinery</p> <p>Table cylinder</p> <p>Automation machinery</p> <p>Medical equipment</p> <p>Smart actuator</p> <p>Cartesian coordinated robot</p> <p>UVW stage</p>	

Standard and maximum lengths of rail

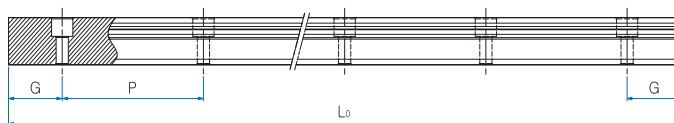

Unit :mm

Model No.	M5	M7	M9	M12	MT12	M15	MT15	M20	MB5	MB7	MB9	MB12	MBT12	MBT13	MB15	MBT15
Standard type	40	40	55	70	70	70	70	220	50	50	50	70	70	110	110	110
	55	55	75	95	95	110	110	280	70	80	80	110	110	150	150	150
	70	70	95	120	120	150	150	340	90	110	110	150	150	190	190	190
	∴	∴	115	145	145	190	190	460	∴	∴	140	190	190	230	230	230
	100	100	∴	170	170	230	230	∴	130	260	∴	230	230	270	270	270
	130	130	275	∴	∴	∴	∴	1120	150	290	500	∴	∴	∴	∴	∴
	160	160	375	570	570	670	670	1240	170	350	710	590	590	750	750	750
Standard maximum length			495	695	695	870	870	1360			860	750	750	790	790	790
				820	820	1070	1070					910	910	910	910	910
	1000	1000	995	995	1995	1990	1990	1960	990	980	2000	1990	1990	1990	1990	1990
	15	15	20	25	25	40	40	60	20	30	30	40	40	40	40	40
G	5	5	7.5	10	10	15	15	20	5	10	10	15	15	15	15	15
Maximum length	1000			2000					1000		2000					

Standard tap hole type of rail

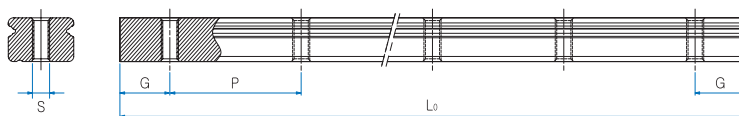

Model No.	S(Penetrated)
M5	M2.6
M7	M3
M9	M4
M12 / MT12	M4
M15 / MT15	M4
M20	M6

Model No.	S(Penetrated)
MB5	M3
MB7	M4
MB9	M4
MB12 / MBT12	M5
MBT13	M5
MB15 / MBT15	M5

# M Series

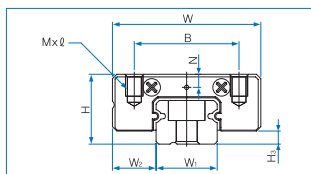
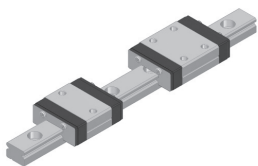

Model N°	External dimensions			Dimensions of block							
	Height H	Width W	Length L	B	C	L <sub>1</sub>	N	E	Grease Nipple	H <sub>3</sub>	
M5C	6	12	17	8	-	M2 X 1,5	9,4	1,2	-	-	1
M5N			20		7		12,4				
M5NA			-	-	M2,6 X 1,5	9,6					
M7C	8	17	19.8	12	-	M2 X 2,5	9,6	1,5	-	-	1.5
M7N			24.3		8		14,1				
M7L			31.8		13		21,6				
M7LA			31.0		12		20,8				
M9C	10	20	22.4	15	-	M3 X 3	11,8	2,2	-	-	2
M9N			31.3		10		20,7				
M9L			41.4		16		30,8				
M9LA			15		12,8						
M12C	13	27	26.4	20	-	M3 X 3,5	12,8	2,7	-	-	3
M12N			34.9		15		21,3				
M 12L			45.4		20		31,8				
M15C	16	32	34.4	25	-	M3 X 4	17,7	3,1	3.3	A-M3	4
M 15N			44.4		20		27,7				
M15L			59.4		25		42,7				
M20C	20	40	39.8	30	-	M4 X 6	22,2	4,2	3.3	A-M3	5
M 20N			51.8		25		34,2				
M 20L			69.8		30		52,2				

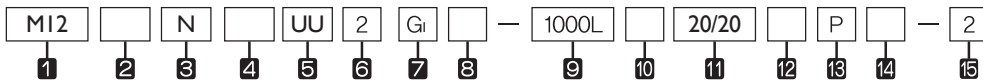

- 1 Model No.
- 2 Material of block : **No symbol**-Stainless / **T**-Carbon steel (\*1)
- 3 Type of block : **C**-Short type/ **N**-Standard type / **L**-Long type
- 4 **No symbol**-Standard block / **E**-Special block specificatio
- 5 Type of seal: **UU**-End seal / **UULF**-End seal+ LF seal (\*2)
- 6 Number of blocks combined in one axis
- 7 Symbol of clearance: **No symbol**-Normal preload / **Gi**-Light preload (\*3)
- 8 Material of end plate: **No symbol**-Standard material / **I** - Stainless / **N** - Aluminum
- 9 Length of rail
- 10 Material of rail: **No symbol**-Stainless / **T**-Carbon steel
- 11 Size of G value: Standard G value has no symbol
- 12 **No symbol**-Rail counterbore type (top assembly) / **A**-Rail tap hole type (bottom assembly) (\*4)
- 13 Symbol of precision: **No symbol**-Moderate / **H**-High / **P**-Precision (\*5)
- 14 **No symbol**-Standard rail / **E**-Special rail specification
- 15 Number of axes used in the same plane

(\*1) The material of carbon steel is confined to M12-M20  
 (\*2) See Symbol List of Optional parts at page 113  
 (\*3) See Radial Clearance at page 30  
 (\*4) See Standard Tap Hole Type of Rail at page 97  
 (\*5) See Selection of Precision Class at page 32

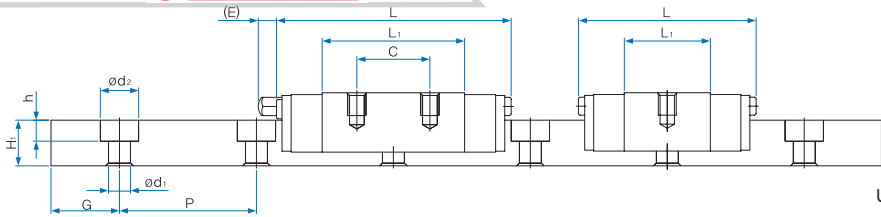

	Dimensions of rail					Basic load rating		Static allowance moment kN m					Mass		
	Width W1 ±0.05	W2	HEIGHT H1	G	Pitch P	d1xd2xh	C N	Co N	M <sub>s</sub> I block	M <sub>s</sub> Double blocks	M <sub>r</sub> I block	M <sub>r</sub> Double blocks	M <sub>t</sub> I block	Block kg	Rail kg/m
5	0	3.5	3.7	5	15	2.4x3.6x0.8	516	757	1.3	7.1	1.3	7.1	2.01	3.1	139
	-0.02						631	1009	2.2	11.6	2.2	11.6	2.67	4.0	
7	0	5	5	5	15	2.4x4.2x2.3	901	1136	1.9	11.8	1.9	11.8	4.14	6.4	253
	-0.02						1197	1703	4.2	23.1	4.2	23.1	6.22	9.0	
							1631	2650	10.1	50.0	10.1	50.0	9.67	12.6	
							1549	2460							
9	0	5.5	6	7.5	20	3.5x6x3.5	1180	1485	3.1	17.9	3.1	17.9	6.90	9.9	391
	-0.02						1721	2545	9.3	46.6	9.3	46.6	11.84	17.1	
							2375	4030	21.9	102.8	21.9	102.8	18.74	25.2	
12	0	7.5	8	10	25	3.5x6.5x4.5	2175	2385	5.4	32.9	5.4	32.9	14.79	19.8	679
	-0.025						3023	3816	14.4	75.8	14.4	75.8	23.66	31.5	
							4246	6200	34.8	169.1	34.8	169.1	38.44	45.9	
15	0	8.5	10	15	40	3.5x6.5x4.5	3418	3895	12.2	71.6	12.2	71.6	29.99	37.8	1071
	-0.025						4540	5842	28.6	148.7	28.6	148.7	44.99	57.6	
							6492	9737	73.5	351.2	73.5	351.2	74.98	85.5	
20	0	10	11	20	60	6x9.5x5.5	4512	5299	20.7	115.9	20.7	115.9	54.05	80.1	1572
	-0.03						6191	8328	50.2	252.7	50.2	252.7	84.94	119.7	
							8396	12870	118.6	554.4	118.6	554.4	131.27	176.4	

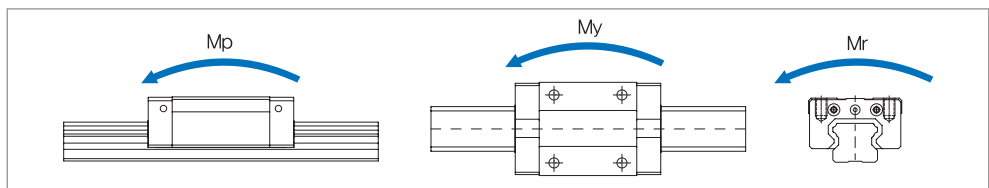

## MB Series

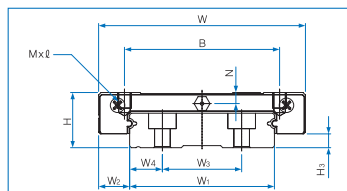

Model N°	External dimensions			Dimensions of block							
	Height H	Width W	Length L	B	C		L <sub>1</sub>	N	E	Grease Nipple	H <sub>3</sub>
MB 5C	6.5	17	21	13	-	M 2.5 X 1.5	13.4	1.4	-	-	1.3
MB 5N			25		-		17.4				
MB 7C	9	25	24	19	-	M3 X 3	12.6	1.7	-	-	2
MB 7N			33		10		21.6				
MB 7L			43.5		19		32.1				
MB 9C	12	30	28.1	21	-	M3 X 3	16.5	3.2	-	-	3
MB 9N			40.1		12		28.6				
MB 9L			52	24	40.4						
MB 12C	14	40	31.1	28	-	M3 X 3.5	17.5	3	-	-	4
MB 12N			44.5		15		30.9				
MB 12L			59.7		28		46.1				
MBT 13C	15	50	35.3	35	-	M4 X 4.5	18.7	3.1	3.3	A-M3	3
MBT 13N			49.2		18		32.6				
MBT 13L			59.7		35		52				
MB 15C	16	60	42.8	45	-	M4 X 4.5	25.2	3.5	3.3	A-M3	4
MB 15N			56.6		20		39				
MB 15L			75.8		35		58.2				

### Composition of Model Name & Number

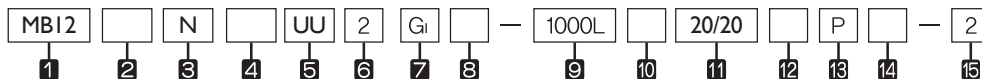

1 Model No.

2 Material of block : No symbol–Stainless / T–Carbon steel (\*1)

3 Type of block : C–Short type/ N–Standard type / L–Long type

4 No symbol–Standard block / E–Special block specification

5 Type of seal: UU–End seal / UULF–End seal+ LF seal (\*2)

6 Number of blocks combined in one axis

7 Symbol of clearance: No symbol–Normal preload / G1–Light preload (\*3)

8 Material of end plate: No symbol–Standard material / I – Stainless / N – Aluminum

9 Length of rail

10 Material of rail: No symbol–Stainless / T–Carbon steel

11 Size of G value: Standard G value has no symbol

12 No symbol–Rail counterbore type (top assembly) / A–Rail tap hole type (bottom assembly) (\*4)

13 Symbol of precision: No symbol–Moderate / H–High / P–Precision (\*5)

14 No symbol–Standard rail / E–Special rail specification

15 Number of axes used in the same plane

(\*1) The material of carbon steel is confined to M12-M20

(\*2) See Symbol List of Optional parts at page 113

(\*3) See Radial Clearance at page 30

(\*4) See Standard Tap Hole Type of Rail at page 97

(\*5) See Selection of Precision Class at page 32

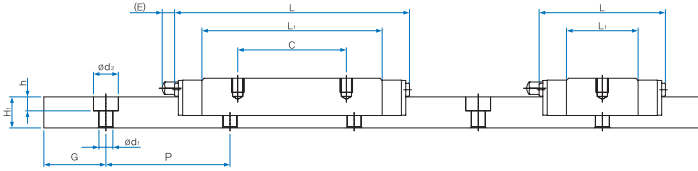

Unit: mm

	Dimensions of rail							Basic load rating		Static allowance moment $I \cdot N \cdot m$					Mass			
	Width W1 $\pm 0.05$	W2	W3	W4	Height H1	G	Pitch P	d1xd2xh	C iN	Co iN	M <sub>p</sub>		M <sub>y</sub>		M <sub>r</sub>		Block kg	Rail kg/m
											I block	Double blocks	I block	Double blocks	I block	Double blocks		
10	0	3.5	-	-	4	5	20	2.9x4.8x1.6	668	1,094	2.6	13.3	2.6	13.3	5.63	5.3	299	
	-0.025								806	1,430	4.4	21.4	4.4	21.4	7.36	6.8		
14	0	5.5	-	-	5.5	10	30	3.5x6x3.2	1,102	1,514	3.4	19.5	3.4	19.5	10.83	11.7	560	
	-0.05								1,631	2,650	10.1	51.1	10.1	51.1	18.95	18.9		
18	0	6	-	-	7	10	30	3.5x6x4.5	1,515	2,121	6.2	33.4	6.2	33.4	19.41	23.4	912	
	-0.05								2,197	3,606	18.2	87.6	18.2	87.6	33.00	39.6		
24	0	8	-	-	8.5	15	40	4.5x8x4.5	2,753	3,339	10.3	57.3	10.3	57.3	40.73	40.5	1369	
	-0.05								4,015	5,723	31.2	152.2	31.2	152.2	69.83	68.4		
30	0	10	-	-	9	15	40	4.5x8x4.5	3,694	4,351	14.3	82.8	14.3	82.8	66.1	60.0	2086	
	-0.05								5,457	7,599	43.7	219.3	43.7	219.3	115.5	103.8		
42	0	9	23	9.5	9.5	15	40	4.5x8x4.5	4,954	6,056	26.9	145.3	26.9	145.3	128.40	85.5	2886	
	-0.05								6,579	9,085	62.5	306.5	62.5	306.5	192.60	126.0		
									9,076	14,384	147.8	680.6	147.8	680.6	304.94	183.6		

1N=0,102kgf

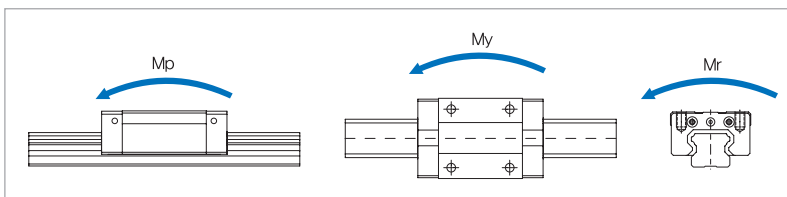

## 9. Roller Linear Motion Guide R Series

### 1) Structure of R Series

WON Linear Motion Guide R Series uses the roller in the raceway surface of a rail and a block as a rolling element, and its four-row cylindrical roller has the contact angle of  $45^\circ$  which makes it possible to bears vertical tensile compression load and horizontal load equally. In the model, a roller, a rolling element, has less elastic displacement than a ball so that its displacement by external load is low. Due to the wide area of contact between the raceway surface and a roller, it can bear high load with high rigidity. Therefore, the model has a long life span, and excellent impact resistance and wear resistance. In addition, since it has less friction resistance, it supports smooth motion and quiet running. By imposing appropriate preload on a roller according to use conditions, it is possible to enhance more rigidity of a linear motion guide.

### 2) Features of R Series

- a. High quality, high precision, and elimination of labor
- b. High rigidity and high precision for implementing stable travel precision for a long time
- c. Excellent wear resistance and friction resistance that ensure a long life
- d. High rigidity and high load capacity, compared to ball type devices with the same model number
- e. Low displacement for impact load or variable load, compared to ball type linear motion guides; excellent vibration resistance with a short vibration decay time for natural frequency
- f. High basic load rating, compared to ball type linear motion guides with the same specification, makes it possible to support a compact design through the use of a smaller model number than that of a ball type device. In case of the same model number, it is possible to have a longer life span due to high load rating.
- g. A variety of specifications for easy design

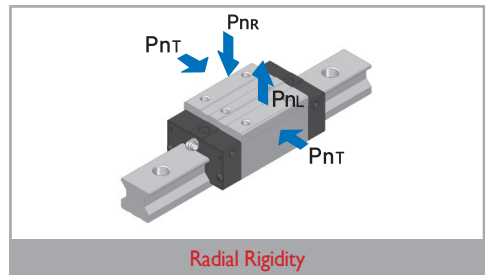
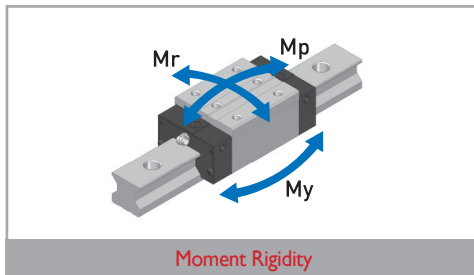

### Tap hole type (A-type)

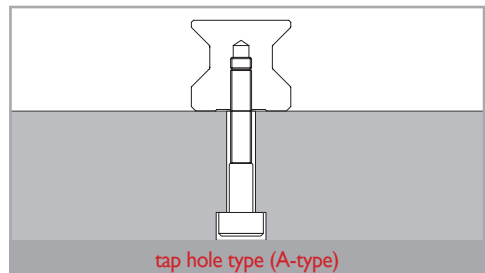
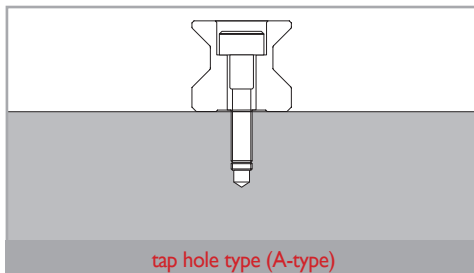

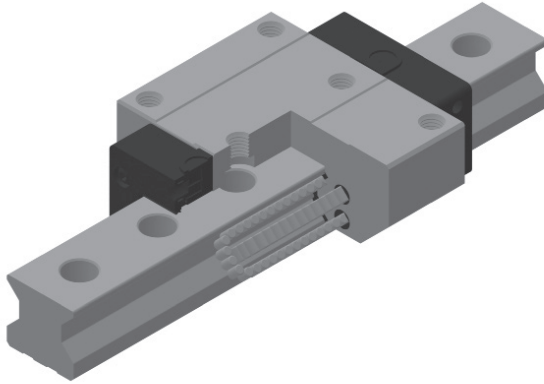

R Series

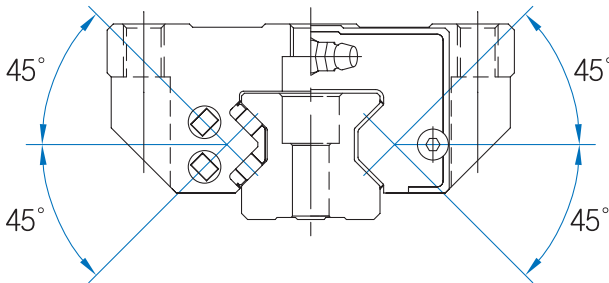

Cross Section

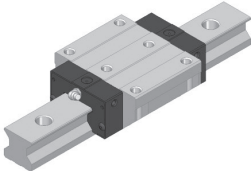
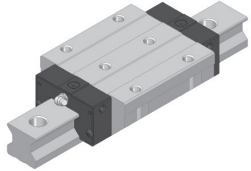
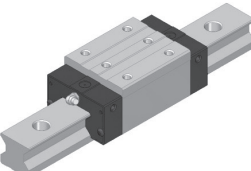
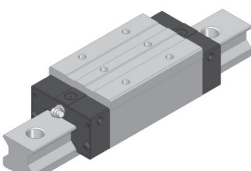

## Types and Features

Category	Type	Shape & Feature	
Flange type	R-FN		<ul style="list-style-type: none"> <li>•A roller type with the tap-processed flange of a block, supporting installation from bottom to top and from top to bottom</li> <li>•4-direction equal load type with high rigidity and high load</li> </ul>
	R-FN		<ul style="list-style-type: none"> <li>•The same cross section as in R-F Series; a roller type with increased load rating by enlarging the entire length (<math>L_1</math>) of a block</li> <li>•4-direction equal load type with high rigidity and high load</li> </ul>
Compact type	R-RN		<ul style="list-style-type: none"> <li>•A compact type with the tap-processed top of a block, minimizing the width (<math>W</math>) of a block</li> <li>•4-direction equal load type with high rigidity and high load</li> </ul>
	R-RL		<ul style="list-style-type: none"> <li>•The same cross section as in R-R Series; a roller type with increased load rating by enlarging the entire length (<math>L_1</math>) of a block</li> <li>•4-direction equal load type with high rigidity and high load</li> </ul>

Machine tool  
CNC machining center  
CNC tapping center  
NC milling machine  
Boring machine  
Multiple machining center  
Planner miller  
Large injection machine  
Heavy-duty cutting machine  
Wire-cut pentahedral processing center  
Display test equipment

## Standard and maximum lengths of rail

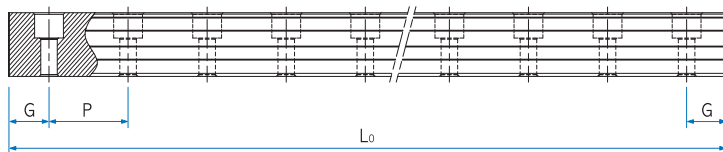

Unit: mm

Model No.	R25	R30	R35	R45	R55	R65
Standard type	220	280	280	570	780	1270
	280	360	360	675	900	1570
	340	440	440	780	1020	1870
	400	520	520	885	1140	2170
	460	600	600	990	1260	2470
	⋮	⋮	⋮	⋮	⋮	2770
	3820	3760	3760	3615	3600	3070
	3880	3840	3840	3720	3720	3670
	3940	3920	3920	3825	3840	3970
	4000	4000	4000	3930	3960	
Standard pitch P	30	40	40	52.5	60	75
G	20	20	20	22.5	30	35
Max. length	4000	4000	4000	3930	3960	3970

## Standard tap hole type of rail

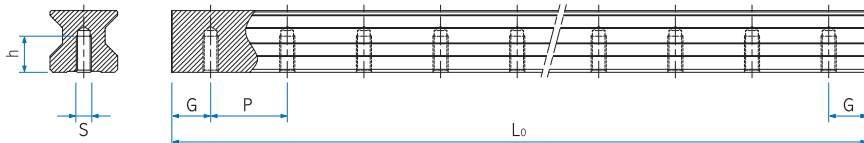

Model No.	S	h(mm)
R25	M6	12
R30	M8	15
R35	M8	17
R45	M12	24
R55	M14	24
R65	M16	25

## R-FN Series, R-FL Series

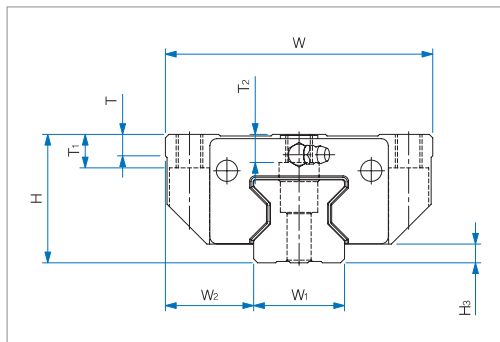
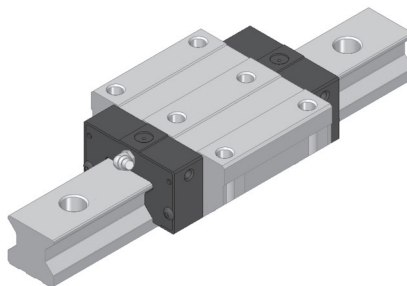

Model No.	External dimensions			Dimensions of block																
	HEIGHT H	Width W	Length L	B	C	C <sub>2</sub>	M	L <sub>1</sub>	T	T <sub>1</sub>	T <sub>2</sub>	N	E	θ <sub>1</sub>	N <sub>1</sub>	θ <sub>2</sub>	Grease nipple	H <sub>2</sub>		
R 25FN	36	70	92.2	57	45	40	M8	63.3	7.5	9	6.7	5.5	12	6	5.5	15.2	B-M6F	6.5		
R 25FL			110.2					81.3											24.2	
R 30FN	42	90	103.8	72	52	44	M10	71	8	11	8	6.5	12	6	6	16	B-M6F	7		
R 30FL			126.6					93.8											27.4	
R 35FN	48	100	118.3	82	62	52	M10	79.5	8	12.5	10.5	7.6	12	12	7.6	16	B-M6F	7		
R 35FL			142.3					103.5											28	
R 45FN	60	120	146.3	100	80	60	M12	101.7	10	15	13.5	8	16	12	8	17.9	B-PT1/8	9.5		
R 45FL			178.8					134.2											34.1	
R 55FN	70	140	168.6	116	95	70	M14	121.6	12	18	13.4	9	16	13.5	9	21.3	B-PT1/8	10		
R 55FL			207.7					160.7											40.9	
R 65FN	90	170	207.2	142	110	82	M16	146.2	15	25	24	13.8	16	18.5	13.8	29.1	B-PT1/8	13		
R 65FL			255.2					194.2											53.1	

## Composition of Model Name & Number

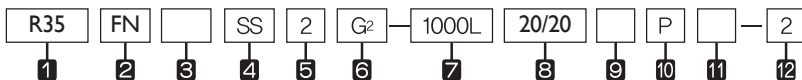

- 1 Model No.
- 2 Type of block : **RN**–Rectangular standard type / **RL**–Rectangular long type/ **FN**–Flange standard type / **FL**–Flange long type
- 3 **No symbol**–Standard block / **E**–Special block specification
- 4 Type of seal : **SS**–End seal+ Inside seal / **ZZ**–End seal+ Inside seal+ Metal scraper (\*1)
- 5 Number of blocks assembled in one shaft
- 6 Symbol of clearance : **No symbol**–Normal preload / **G1**–Light preload / **G2**–Heavy preload / **Gs**–Special preload (\*2)
- 7 Length of rail
- 8 Size of G value: standard G value has no symbol
- 9 **No symbol**–Rail counterbore type (top assembly) / **A**– Rail tap hole type (bottom assembly) (\*3)
- 10 Symbol of precision : **No symbol**–Moderate / **H**–High / **P**–Precision / **SP**–Super precision / **UP**–Ultra precision (\*4)
- 11 **No symbol**–Standard rail / **E**–special rail specification
- 12 Number of axes used in the same plane

(\*1) See Symbol List of Optional Parts at page 113. (\*2) See Radial Clearance at page 30.  
(\*3) See Standard Tap Hole Type of Rail at page 105. (\*4) See Selection of Precision Class at page 35.

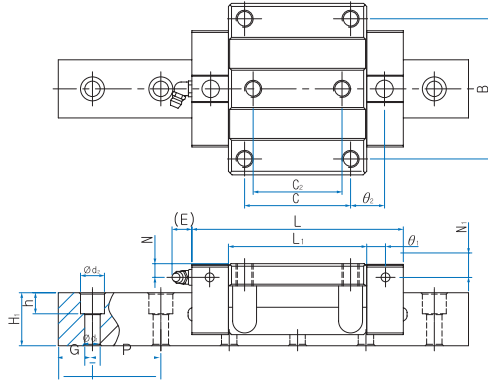

Unit : mm

Width W1 ±0.05	Dimensions of rail					Basic load rating		Static allowance moment (N m)					Mass	
	W2	Height H1	G	Pitch P	d1x d2x h	C N	Co IN	M <sub>1</sub>		M <sub>2</sub>		M <sub>3</sub> I block	Block kg	Rail kg/m
								I block	Double blocks	I block	Double blocks			
23	23.5	24	20	30	7x11x9.7	29.1	56.2	0.570	3.090	0.570	3.090	0.820	0.8	3.1
						35.6	73.1	0.925	4.949	0.925	4.949	1.065	1.1	
28	31	28	20	40	9x14x12	44.4	87.3	0.985	5.395	0.985	5.395	1.470	1.4	4.4
						55.0	114.8	1.640	8.946	1.640	8.946	1.935	1.9	
34	33	31	20	40	9x14x12	61.0	114.0	1.460	7.972	1.460	7.972	2.345	2.1	6.2
						75.6	150.0	2.450	13.036	2.450	13.036	3.090	2.8	
45	37.5	38	22.5	52.5	14x20x17	103.8	202.0	3.265	17.712	3.265	17.712	5.430	4.0	10.1
						132.3	276.2	5.840	30.565	5.840	30.565	7.440	5.3	
53	43.5	43.5	30	60	16x23x20	146.9	278.0	5.390	28.523	5.390	28.523	8.880	6.8	13.4
						181.9	380.3	8.960	49.534	8.960	49.534	11.690	8.9	
63	53.5	55	35	75	18x26x22	231.0	450.6	10.600	56.301	10.600	56.301	17.140	13.0	20.1
						303.0	576.0	18.160	91.519	18.160	91.519	21.910	17.2	

IN = 0.102kgf

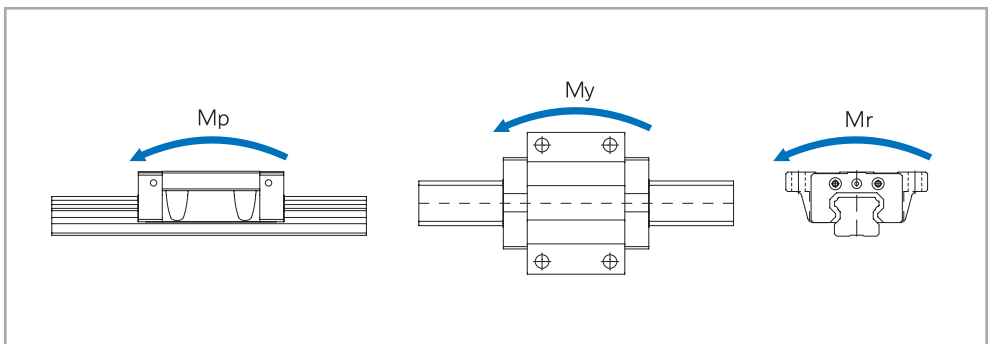

## R-RN Series, R-RL Series

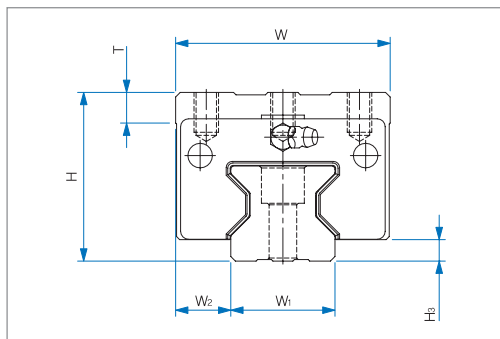
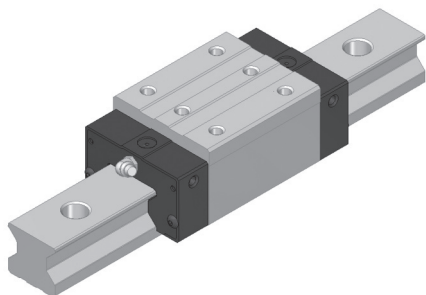

Model No.	External dimensions			Dimensions of block											Grease nipple	H <sub>i</sub>
	Height H	Width W	Length L	B	C	M X L	L <sub>i</sub>	T	N	E	θ <sub>1</sub>	N <sub>i</sub>	θ <sub>2</sub>			
R 25RN	40	48	92.2	35	35	M6 x 9	63.3	9	9.5	12	6	9.5	20.2	B-M6F	6.5	
R 25RL			110.2		50		81.3						21.7			
R 30RN	45	60	103.8	40	40	M8 x 11	71	9	9.5	12	6	9	22	B-M6F	7	
R 30RL			126.6		60		93.8						23.4			
R 35RN	55	70	118.3	50	50	M8 x 13	79.5	12	14.6	12	12	14.6	22	B-M6F	7	
R 35RL			142.3		72		103.5						23			
R 45RN	70	86	146.3	60	60	M10 x 20	101.7	20	18	16	12	18	27.9	B-PT1/8	9.5	
R 45RL			178.8		80		134.2						34.1			
R 55RN	80	100	168.6	75	75	M12 x 19	121.6	20	19	16	13.5	19	31.3	B-PT1/8	10	
R 55RL			207.7		95		160.7						40.9			

## Composition of Model Name & Number

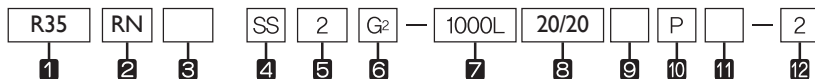

- 1 Model No.
- 2 Type of block : RN—Rectangular standard type / RL—Rectangular long type/ FN—Flange standard type / FL—Flange long type
- 3 No symbol—Standard block / E—Special block specification
- 4 Type of seal : SS—End seal+ Inside seal / ZZ—End seal+ Inside seal+ Metal scraper (\*1)
- 5 Number of blocks assembled in one shaft
- 6 Symbol of clearance : No symbol—Normal preload / G<sub>1</sub>—Light preload / G<sub>2</sub>—Heavy preload / G<sub>s</sub>—Special preload (\*2)
- 7 Length of rail
- 8 Size of G value: standard G value has no symbol
- 9 No symbol—Rail counterbore type (top assembly) / A— Rail tap hole type (bottom assembly) (\*3)
- 10 Symbol of precision : No symbol—Moderate / H—High / P—Precision / SP—Super precision / UP—Ultra precision (\*4)
- 11 No symbol—Standard rail / E—special rail specification
- 12 Number of axes used in the same plane

(\*1) See Symbol List of Optional Parts at page 113. (\*2) See Radial Clearance at page 30.

(\*3) See Standard Tap Hole Type of Rail at page 105. (\*4) See Selection of Precision Class at page 35.

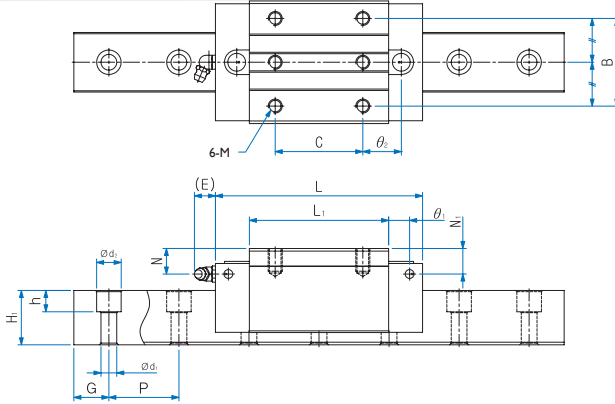

Unit: mm

Width W <sub>1</sub> ±0.05	DIMENSIONS OF RAIL					BASIC LOAD RATING		STATIC ALLOWANCE MOMENT kN m					MASS	
	W <sub>2</sub>	Height H <sub>1</sub>	G	Pitch P	d <sub>1</sub> x d <sub>2</sub> x h	C N	C <sub>0</sub> N	M <sub>1</sub>		M <sub>2</sub>		M <sub>3</sub>	Block kg	Rail kg/m
								1 block	Double blocks	1 block	Double blocks			
23	12.5	24	20	30	7x11x9.7	29.1	56.2	0.570	3.090	0.570	3.090	0.820	0.7	3.1
								0.925	4.949	0.925	4.949	1.065	0.9	
28	16	28	20	40	9x14x12	44.4	87.3	0.985	5.395	0.985	5.395	1.470	1.2	4.4
								1.640	8.946	1.640	8.946	1.935	1.5	
34	18	31	20	40	9x14x12	61.0	114.0	1.460	7.972	1.460	7.972	2.345	2.0	6.2
								2.450	13.036	2.450	13.036	3.090	2.5	
45	20.5	38	22.5	52.5	14x20x17	103.8	202.0	3.265	17.712	3.265	17.712	5.430	3.9	10.1
								5.840	30.565	5.840	30.565	7.440	5.0	
53	23.5	43.5	30	60	16x23x20	146.9	278.0	5.390	28.523	5.390	28.523	8.880	6.2	13.4
								8.960	49.534	8.960	49.534	11.690	8.1	

IN□0.102kgf

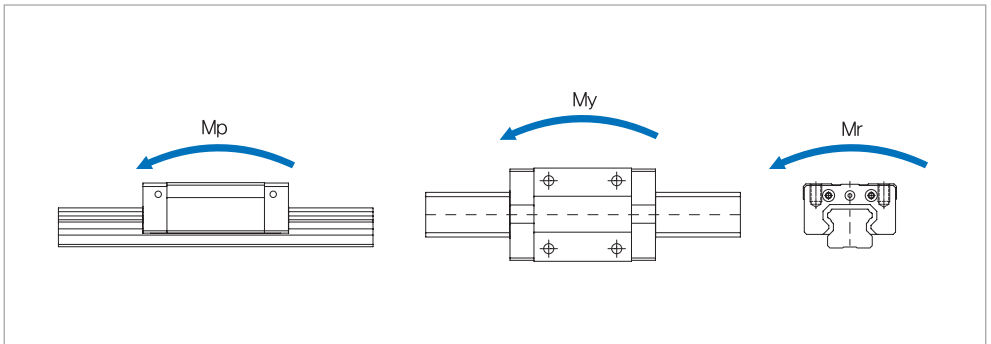

## RS-RN Series, RS-RL Series

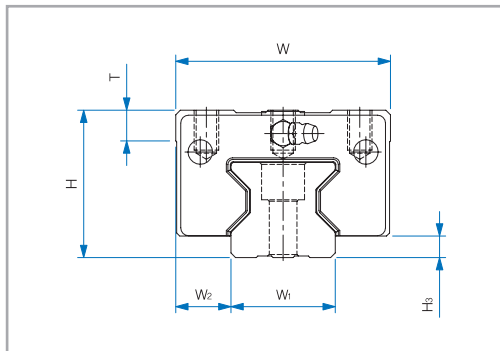
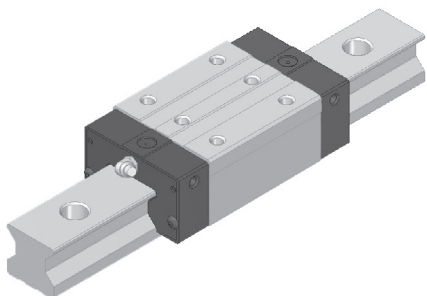

Model No.	External dimensions			Dimensions of block													Grease nipple	H <sub>3</sub>
	Height H	Width W	Length L	B	C	M X L	L <sub>i</sub>	T	N	E	θ <sub>1</sub>	N <sub>i</sub>	θ <sub>2</sub>					
RS 25RN	36	48	92.2	35	35	M6 x 9	63.3	9	5.5	12	6	5.5	20.2	B-M6F	6.5			
RS 25RL			110.2				81.3						21.7					
RS 35RN	48	70	118.3	50	50	M8 x 12	79.5	12	7.6	12	12	7.6	22	B-M6F	7			
RS 35RL			142.3				103.5						23					
RS 45RN	60	86	146.3	60	60	M10 x 18	101.7	20	8	16	12	8	27.9	B-PTI/8	9.5			
RS 45RL			178.8				134.2						34.1					
RS 55RN	70	100	168.6	75	75	M12 x 19	121.6	20	9	16	13.5	9	31.3	B-PTI/8	10			
RS 55RL			207.7				160.7						40.9					
RS 65RN	90	126	207.2	76	70	M16 x 21	146.2	20	13.8	16	18.5	13.8	49.1	B-PTI/8	13			
RS 65RL			255.2				194.2						48.1					

### Composition of Model Name & Number

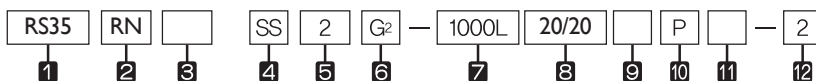

- 1 Model No.
- 2 Type of block : **RN**–Rectangular standard type / **RL**–Rectangular long type
- 3 **No symbol**–Standard block / **E**–Special block specification
- 4 Type of seal : **SS**–End seal+ Inside seal / **ZZ**–End seal+ Inside seal+ Metal scraper <sup>(\*)1</sup>
- 5 Number of blocks assembled in one shaft
- 6 Symbol of clearance : **No symbol**–Normal preload / **G1**–Light preload / **G2**–Heavy preload / **Gs**–Special preload <sup>(\*)2</sup>
- 7 Length of rail
- 8 Size of G value: standard G value has no symbol
- 9 **No symbol**–Rail counterbore type (top assembly) / **A**– Rail tap hole type (bottom assembly) <sup>(\*)3</sup>
- 10 Symbol of precision : **No symbol**–Moderate / **H**–High / **P**–Precision / **SP**–Super precision / **UP**–Ultra precision <sup>(\*)4</sup>
- 11 **No symbol**–Standard rail / **E**–special rail specification
- 12 Number of axes used in the same plane

<sup>(\*)1</sup> See Symbol List of Optional Parts at page 113. <sup>(\*)2</sup> See Radial Clearance at page 30.

<sup>(\*)3</sup> See Standard Tap Hole Type of Rail at page 105. <sup>(\*)4</sup> See Selection of Precision Class at page 35.

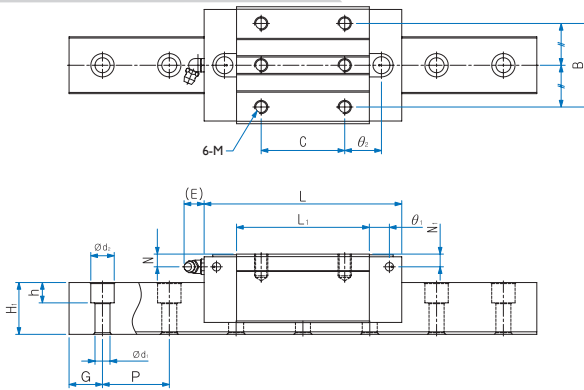

Unit: mm

Width $W_1$ $\pm 0.05$	Dimensions of rail					Basic load rating		STATIC ALLOWANCE MOMENT $\mu\text{N m}$					Mass	
	$W_2$	Height $H_1$	G	Pitch P	$d_1 \times d_2 \times h$	C N	$C_0$ N	$M_x$		$M_y$		$M_z$	Block kg	Rail kg/m
								1 block	Double blocks	1 block	Double blocks			
23	12.5	24	20	30	7x11x9.7	29.1	56.2	0.570	3.090	0.570	3.090	0.820	0.6	3.1
						35.6	73.1	0.925	4.949	0.925	4.949	1.065	0.8	
34	18	31	20	40	9x14x12	61.0	114.0	1.460	7.972	1.460	7.972	2.345	1.7	6.2
						75.6	150.0	2.450	13.036	2.450	13.036	3.090	2.1	
45	20.5	38	22.5	52.5	14x20x17	103.8	202.0	3.265	17.712	3.265	17.712	5.430	3.2	10.1
						132.3	276.2	5.840	30.565	5.840	30.565	7.440	4.2	
53	23.5	43.5	30	60	16x23x20	146.9	278.0	5.390	28.523	5.390	28.523	8.880	5.3	13.4
						181.9	380.3	8.960	49.534	8.960	49.534	11.690	6.8	
63	31.5	55	35	75	18x26x22	231.0	450.6	5.390	34.735	5.390	34.735	8.880	30.4	20.1
						303.0	576.0	8.960	60.425	8.960	60.425	11.690	33.6	

1N  $\approx$  0.102kgf

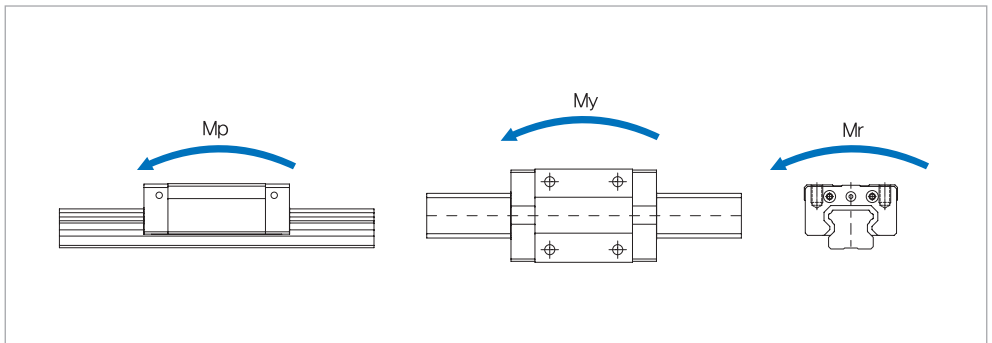



## 13 Options

### I. Seal and rail cap

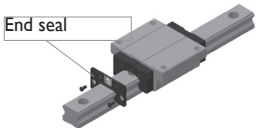
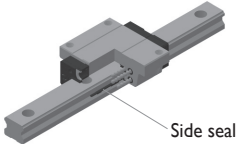
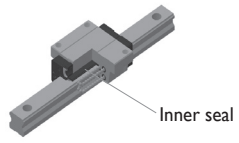
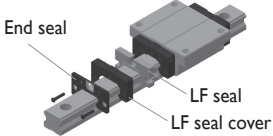
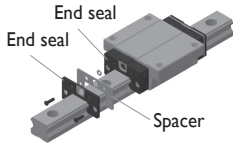
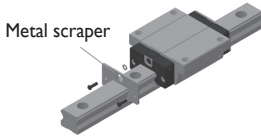
Item	Seal attachment position	Applied environments
End seal		<ul style="list-style-type: none"> <li>•Where there is a lot of dust or particles</li> </ul>
Side seal		<ul style="list-style-type: none"> <li>•Where foreign substance can easily flow in from the flank or bottom</li> <li>•Where the assembled linear motion guide moves in a vertical, horizontal, or reverse direction</li> </ul>
Inner seal		<ul style="list-style-type: none"> <li>•Where there are a lot of cutting chips or foreign substance</li> <li>•Where cutting chips or foreign substances are highly likely to flow into a block</li> </ul>
LF seal		<ul style="list-style-type: none"> <li>•Where a long interval of refilling is needed due to a narrow space</li> <li>•An environment at 40°C or so</li> <li>•Where there needs to avoid any contact with organic solvents, such as thinner or milky white oil</li> </ul>
Double seal		<ul style="list-style-type: none"> <li>•Where strong sealing is needed due to a lot of dust or cutting chips</li> </ul>
Metal scarpers		<ul style="list-style-type: none"> <li>•Where spatters, such as slag or metal powder, arise in welding</li> </ul>

## Symbol List of Optional Parts

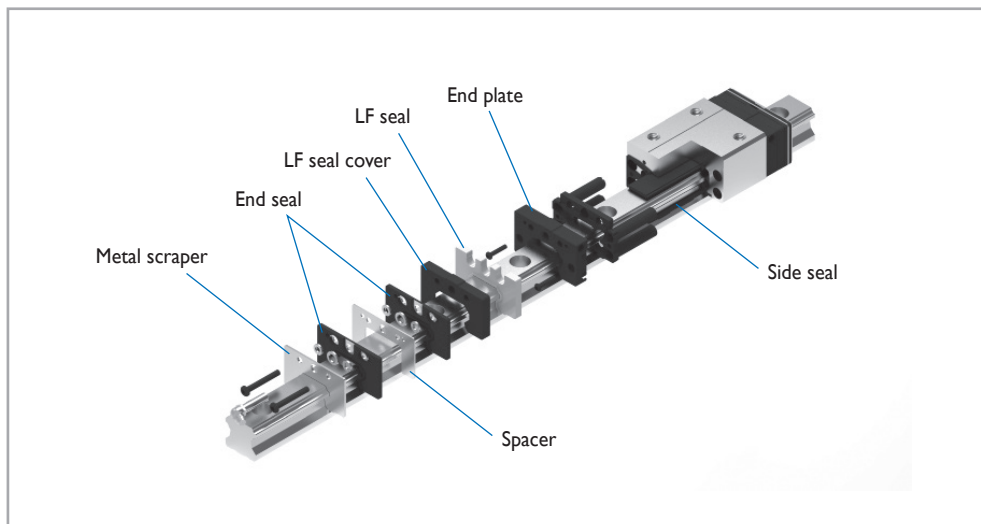

Symbol	Optional parts
UU	End seal
SS	Side seal+ Inner seal + End seal
DD	Side seal+ Inner seal + End seal+ Spacer+ End seal
ZZ	Side seal+ Inner seal + End seal+ Metal scraper
KK	Side seal+ Inner seal + End seal+ Spacer+ End seal+ Metal scraper
UUUF	LF Unit+ End seal
SSLF	Side seal+ Inner seal + LF Unit+ End seal
DDLf	Side seal+ Inner seal + LF Unit+ End seal+ Spacer+ End seal
ZZLf	Side seal+ Inner seal + LF Unit+ End seal+ Metal scraper
KKLf	Side seal+ Inner seal + LF Unit+ End seal+ Spacer+ End seal+ Metal scraper

Optional-parts mapping table by model number

Model No.	Full ball type								Spacer ball chain type					Full roller type	
	H		HB	S		HS		M	MB	H...S		HS...S		S...S	R
	15~25	30~55	17~35	15~25	25	30~35	5~20	5~15	15~25	30~35	25	30~35	15~25	25~65	
End seal	UU	•	•	•	•	•	•	•	•	•	•	•	•	•	
Side seal	-	•	*1)	-	•	•	*1)	-	-	•	*1)	•	*1)	•	-
Inner seal	-	•	•	-	•	•	•	-	-	•	•	•	•	•	-
Side seal +Inner seal +End seal	SS	•	•	*2)	•	•	•	-	-	•	•	•	•	•	*2)
Side seal +Inner seal +End seal +Metal scraper	ZZ	•	•	•	•	•	•	-	-	•	•	•	•	•	*3)
Side seal +Inner seal +Double seal	DD	•	•	•	•	•	•	-	-	•	•	•	•	•	*3)
Side seal +Inner seal +End seal +Metal scraper	KK	•	•	•	•	•	•	-	-	•	•	•	•	•	*3)
LF seal +End seal	UULF	•	•	•	•	•	•	•	•	•	•	•	•	•	*3)
LF seal +Side seal +Inner seal +End seal	SSLF	•	•	•	•	•	•	-	-	•	•	•	•	•	*3)
LF seal +Side seal +Inner seal +Double seal	DDLF	•	•	•	•	•	•	-	-	•	•	•	•	•	*3)
LF seal +Side seal +Inner seal +End seal +Metal scraper	ZZLF	•	•	•	•	•	•	-	-	•	•	•	•	•	*3)
LF seal +Side seal +Inner seal +Double seal +Metal scraper	KKLF	•	•	-	•	•	•	-	-	•	•	•	•	•	*3)

\*1) In H,HS,H...S,and HS...S Series, the basic optional part of model no. 30 and no.35 is Inner Seal.

\*2) In H Series (model no. 45 and no. 55) and HB Series and R Series, Side Seal and Inner Seal is an integral type.

\*3) In R Series, if it is necessary to apply LF seal and metal scrapper, please contact us.

## Dimension Table of the Installation of Optional Parts

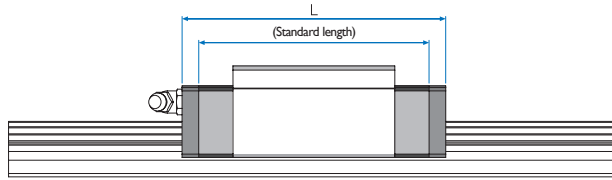

Unit:mm

	Model No.	L									
		UU	SS	ZZ	DD	KK	UULF	SSLF	DDLf	ZZLF	KKLF
H	15 FN/RN/FN...S/RN...S	56.5	56.5	60.7	61.5	65.7	70.5	70.5	75.5	74.7	79.7
	15 FL/RL/FL...S/RL...S	64.8	64.8	69	69.8	74	78.8	78.8	83.8	83	88
	20 FN/RN/FN...S/RN...S	73.2	73.2	78.2	79.4	84.4	87.2	87.2	93.4	92.2	98.4
	20 FL/RL/FL...S/RL...S	89.1	89.1	94.1	95.3	100.3	103.1	103.1	109.3	108.1	114.3
	25 FN/RN/FN...S/RN...S	83.2	93.2	89.2	90.4	96.4	97.2	97.2	104.4	103.2	110.4
	25 FL/RL/FL...S/RL...S	103.1	103.1	109.1	110.3	116.3	117.1	117.1	124.3	123.1	130.3
	30 FN/RN/FN...S/RN...S	99.3	99.3	105.3	106.5	112.5	113.3	113.3	120.5	119.3	126.5
	30 FL/RL/FL...S/RL...S	121.5	121.5	127.5	128.7	134.7	135.5	135.5	142.7	141.5	148.7
	35 FN/RN/FN...S/RN...S	111.8	111.8	117.8	119	125	125.8	125.8	133	131.8	139
	35 FL/RL/FL...S/RL...S	137.2	137.2	143.2	144.4	150.4	151.2	151.2	158.4	157.2	164.4
HB	17 F/R	51	51	54.6	-	-	61.2	61.2	-	64.8	-
	21 F/R	59	59	63.4	-	-	69.2	69.2	-	73.6	-
	27 F/R	72.5	72.5	76.9	-	-	85.1	85.1	-	89.5	-
	35 F/R	105.3	105.3	110.9	-	-	120.3	120.3	-	125.9	-
	15 FC/RC/FC...S/RC...S	39.8	39.8	44	44.8	49	53.8	53.8	58.8	58	63
S	15 FN/RN/FN...S/RN...S	56.5	56.5	60.7	61.5	65.7	70.5	70.5	75.5	74.7	79.7
	20 FC/RC/FC...S/RC...S	47.8	47.8	52.8	54	59	61.8	61.8	68	66.8	73
	20 FN/RN/FN...S/RN...S	66.8	66.8	71.8	73	78	80.8	80.8	87	85.8	92
	25 FC/RC/FC...S/RC...S	59.4	59.4	65.4	66.6	72.6	73.4	73.4	80.6	79.4	86.6
	25 FN/RN/FN...S/RN...S	83.2	83.2	89.2	90.4	96.4	97.2	97.2	104.4	103.2	110.4
HS	25 RN/RN...S	83.2	83.2	89.2	90.4	96.4	97.2	97.2	104.4	103.2	110.4
	25 RL/RL...S	103.1	103.1	109.1	110.3	116.3	117.1	117.1	124.3	123.1	130.3
	30 RN/RN...S	99.3	99.3	105.3	106.5	112.5	113.3	113.3	120.5	119.3	126.5
	30 RL/RL...S	121.5	121.5	127.5	128.7	134.7	135.5	135.5	142.7	141.5	148.7
	35 RN/RN...S	111.8	111.8	117.8	119	125	125.8	125.8	133	131.8	139
35 RL/RL...S	137.2	137.2	143.2	144.4	150.4	151.2	151.2	158.4	157.2	164.4	

Unit:mm

Unit:mm

	Model No.	L	
		UU	UULF
M	5 C	17	21.4
	5 N/NA	20	24.4
	7 C	19.8	24.8
	7 N	24.3	29.3
	7 L/LA	31.8	36.8
	9 C	22.4	27.4
	9 N	31.3	36.3
	9 L/LA	41.4	46.4
	12 C	26.4	32.4
	12 N	34.9	40.9
	12 L	45.4	51.4
	15 C	34.4	41.4
	15 N	44.4	51.4
	15 L	59.4	66.4
	20 C	39.8	46.8
20 N	51.8	58.8	
20 L	69.8	76.8	

	Model No.	L	
		UU	UULF
MB	5C	21	25.4
	5N	25	29.4
	7C	24	29
	7N	33	38
	7L	43.5	48.5
	9C	28.1	33.1
	9N	40.2	45.2
	9L	52	57
	12C	31.1	37.1
	12N	44.5	50.5
	12L	59.7	65.7
	13C	35.3	42.3
	13N	49.2	56.2
	13L	68.6	75.6
	15C	42.8	49.8
15N	56.6	63.6	
15L	75.8	82.8	

## 2. Oil inlet

In R Series, it is possible to refill on the side and top. The standard specification of an oil inlet is 'not run through', in order to prevent foreign substances from flowing in a block. For use, please contact WON ST

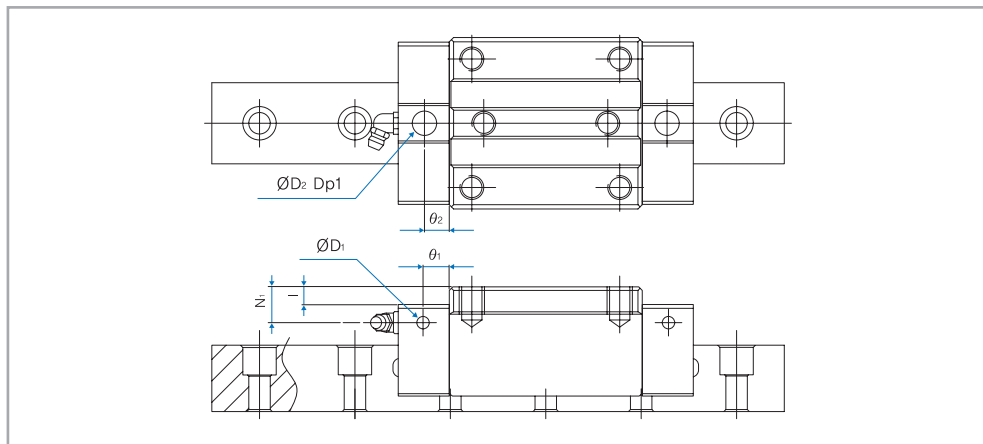

Unit :mm

Model No.	Hole for a side nipple			Top oil inlet				
	$\varnothing_1$	$N_1$	$D_1$	$D_2$	(O-ring)	l	$\varnothing_2$	
R	25F(L)	6	5.5	3.3	10.2	P7	0.4	6
	30F(L)	6	6	5.1	10.2	P7	0.4	6.5
	35F(L)	12	7.6	5.1	10.2	P7	0.4	7.25
	45F(L)	12	8	5.1	10.2	P7	0.4	7
	55F(L)	13.5	9	5.1	10.2	P7	0.4	8
	65F(L)	18.5	13.75	5.4	10.2	P7	0.4	11
	25R(L)	6	9.5	3.3	10.2	P7	4.4	6
	30R(L)	6	9	5.1	10.2	P7	3.4	6.5
	35R(L)	12	14.6	5.1	10.2	P7	7.4	7.25
	45R(L)	12	18	5.1	10.2	P7	10.4	7
RS	55R(L)	13.5	19	5.1	10.2	P7	10.4	8
	25R(L)	6	5.5	3.3	10.2	P7	0.4	6
	35R(L)	12	7.6	5.1	10.2	P7	0.4	7.25
	45R(L)	12	8	5.1	10.2	P7	0.4	7
	55R(L)	13.5	9	5.1	10.2	P7	0.4	8
	65R(L)	18.5	13.75	5.4	10.2	P7	0.4	11

### 3. Grease nipple

WON ST provides various types of grease nipples necessary for lubricating a linear motion system.

A-Ø3	A-M3	A-M5	B-M6F	B-PT 1/8
HW 17,21	M 15,20 MB 13,15	H 15 S 15	H 20,25,30,35 HW 27,35 S 20,25	H 45,55

Applied model no.	Nipple model no.	Thread (L) length									
		UU	SS	DD	ZZ	KK	UULF	SSLF	DDLF	ZZLF	KKLF
HB17, HB21	A-Ø3	4	4	-	6.5	-	9	9	-	11	-
M15, M20, MB13, MB15	A-M3	4.2	4.2	-	-	-	7.7	7.7	-	-	-
S-H15	A-M5	5	5	7.5	7.5	10	12	12	14.5	14.5	17
S-H20	B-M6F	7	7	10	10	12	14.5	14.5	17	17	19
S-H25, 30		7	7	12	12	14.5	14.5	14.5	19	19	22
H35		10	10	14.5	14.5	17	17	17	19	19	22
HB27		5	5	-	7	-	12	12	-	14.5	-
HB35		5	5	-	10	-	12	12	-	17	-
H45, H55	B-PT 1/8	8	8	-	11	-	15.5	15.5	-	18	-

## 4. Connection of oil pipes

### WOL Type

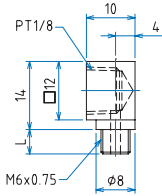

WOL-A

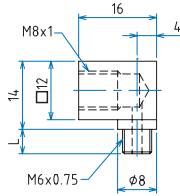

WOL-B

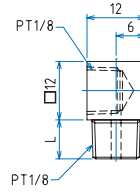

WOL-C

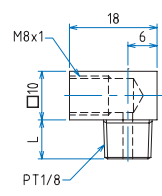

WOL-D

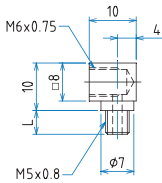

WOL-E

### WOSType

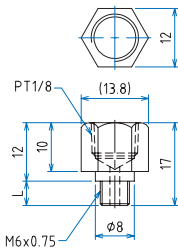

WOS-A

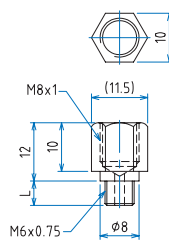

WOS-B

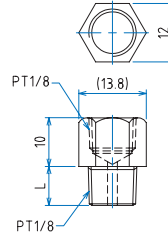

WOS-C

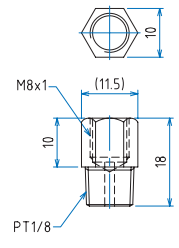

WOS-D

Applied model no.	Nipple model no.	Thread (L) length									
		UU	SS	DD	ZZ	KK	UULF	SSLF	DDLF	ZZLF	KKLF
S-H15	WOL-E	5	5	7.5	7.5	10	12	12	14.5	14.5	17
S-H20	WOS-B	7	7	10	10	12	14.5	14.5	17	17	19
S-H25, H30	WOL-A, WOL-B WOS-A, WOS-B	7	7	12	12	14.5	14.5	14.5	19	19	22
H35		10	10	14.5	14.5	17	17	17	19	19	22
HB27		5	5	-	7	-	12	12	-	14.5	-
HB35	WOL-C, WOL-D WOS-C, WOS-D	5	5	-	10	-	12	12	-	17	-
H45, H55		8	8	-	11	-	15.5	15.5	-	18	-

## 5. How to install with the use of a support rail

To get a block of a linear motion guide in or out of a rail, it is required to use a support rail for safety. If a rail is mounted on a rail without any support rail, a rolling element can be separated from the block. Moreover, internal parts can be damaged or destroyed by foreign substances.

Installing a block without a rolling element may sharply shorten life of the block, reduce load, and cause early destruction. If you use a support rail, do not lean it. Adhere it to the end of a rail first and then push it in the rail direction by apply force gradually. If a block has a rolling element separated and gets contaminated by dust, please do not use the product but contact WON ST.

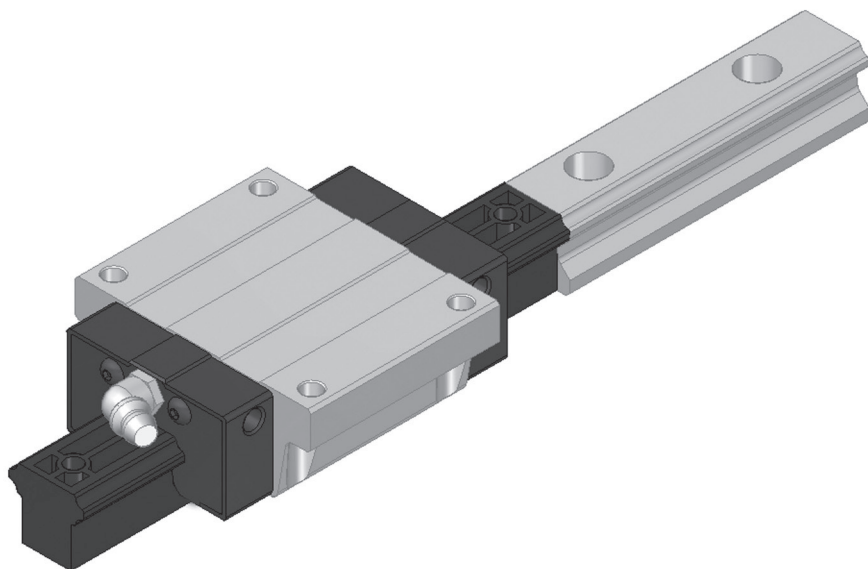



## 14 Precautions for Handling Linear Motion Guide

### 1. Handling

- 1) WON Linear Motion Guide is damp-proof packaged after grease removal and cleaning. So, please open it right before use.
- 2) As for the compatible product of rail and block, a plastic support rail is combined with the block. Please assemble it with the rail carefully.
- 3) If you reassemble a block-rail set product or a single block product after dismantling it into pieces, foreign substance may intrude into the block or cause performance degradation that leads to unsmooth rolling motion or damage. So please do not disassemble it at your discretion.
- 4) If either a rail or a block leans to one side, the block or rail may fall to be damaged. Please be careful not to get a block or rail separated.
- 5) A block' end plate is made of plastic. Imposing an impact on it may cause its damage. Please be careful

### 2. Lubrication

- 1) If the product supplied is coated with rust preventive oil, clean it off thoroughly first and then fill with a lubricant before use.
- 2) DO NOT mix with other lubricants with a different thickener or additive. If so, it may destroy the structure of grease or cause a harmful effect.
- 3) Viscosity of grease depends on temperature. It increases in winter due to low temperature, and friction of a linear motion guide resistance may increase.
- 4) If you need to use a special lubricant, please contact WON ST before use.
- 5) When you use oil as a lubricant, oil may fail to reach the raceway groove depending on the assembly status or direction of a block or rail. In this case, there is no lubrication effect. WON ST offers different lubrication methods suitable for assembly environments. So please contact us.

### 3. Caution for use

- 1) After opening the product, please put a damp-proof agent in a dry container for storage.
- 2) Please handle the product after wearing plastic gloves in a clean place.
- 3) Please be careful to prevent foreign substances that may impede rolling motion or cause functional damage.
- 4) Please use a holding door or cover to prevent a linear motion guide from being exposed directly to poor environments that may cause corrosion or damage.
- 5) As for the linear motion guide based on standard plastic end plate, use it at 80°C or below. If you need to use it at 80°C or above, please order a special metal end plate.
- 6) If rail of a linear motion guide is fixed at ceiling or in a high place and its block bears load downwards, it is possible for the block to be separated from the rail and for the block and its attached parts to fall as the end plate is damaged or a ball falls off. So, it is required to take safety measures, such as the installation of a safety device.

### 4. Storage

A rail may warp depending on a storage condition. For storage, place a linear motion guide horizontally in the package box offered by WON ST or its equivalent box with the flat bottom. Avoid a place with high or low temperature and high humidity.

## Troubles and Troubleshooting of Linear Motion Guide

Type	Trouble	Cause	Action
Fatigue failure of the rolling surface	<ul style="list-style-type: none"> <li>•Flaking</li> <li>- Caused by rolling fatigue of the rolling surface</li> <li>- Maximum shear stress-induced internal cracks are expressed on the surface.</li> </ul>	Damage by life	Replace the linear motion guide.
		Overload	Review the model no. selected; Use a higher model no; Lower a level of load; Reinforce assembly precision for installation; Enhance the rigidity of base and table
		Poor lubrication	Refill a lubricant; Shorten a refilling cycle of lubricant; Review the lubricant in use; Improve the lubricant passage.
		Intrusion of foreign substances	Improve seal performance; Add a seal; Take additional measures for dust prevention.
Indentation of the rolling surface	<ul style="list-style-type: none"> <li>•Indentation</li> <li>- Caused by plastic deformation of the rolling surface due to excessive external load</li> </ul>	Impact load or excessive external load	Review the model no. selected; Make service conditions less strict; Lower a level of load; Reinforce assembly precision for installation; Use a higher model no.
		Careless handling	Improve the methods and conditions of handling to prevent impact and fall.
Seizing	<ul style="list-style-type: none"> <li>•Burning</li> <li>- Rough surface of the rolling surface due to slight burning by friction between a rolling element and the rolling surface</li> <li>- Cause for the discoloration of the rolling surface, weakened hardness, and flaking</li> </ul>	Poor lubrication	Refill a lubricant; Use an appropriate lubricant; Improve lubrication
		Overload	Review service conditions; Lower a level of load; Use a higher model no.; Enhance assembly precision for installation.
Cracking	<ul style="list-style-type: none"> <li>•Cracking</li> <li>- Partial breaking into pieces of a rolling element or rolling surface due to excessive external load</li> </ul>	Impact load or excessive external load	Review the model no. selected; Use a higher model no.; Lower a level of load; Reinforce assembly precision for installation
		Poor raceway circulation of a rolling element	Prevent foreign substances; Improve measures for dust prevention; Refill a lubricant; Shorten a refilling cycle of lubricant; Improve lubrication
Abnormal wear	<ul style="list-style-type: none"> <li>•Abnormal wear</li> <li>- Caused by the sliding of a rolling element and the rolling surface; the more sliding, the rapidly more wear</li> <li>- Accompany oxidation wear causing poor precision and preload failure</li> </ul>	Impact load or excessive external load	Review the model no. selected; Use a higher model no.; Lower a level of load; Reinforce assembly precision for installation.
		Intrusion of foreign substances	Reinforce seal performance; Improve measures for dust prevention
		Poor lubrication	Refill a lubricant; Use an appropriate lubricant; Improve lubrication; Improve the lubrication passage.
Flattening corrosion	<ul style="list-style-type: none"> <li>•Vibration</li> <li>- This problem arises when running at vibrant stroke causes the loss of oil film, and the oxidation of the fine dust caused by the sliding of a rolling element and the rolling surface facilitates wear.</li> </ul>	Load	Review service conditions; Use a higher model no.; Reinforce assembly precision for installation.
		Vibration	Improve transfer conditions; Replace a lubricant; Improve lubrication; Shorten a refilling cycle of lubricant.
		Intrusion of foreign substances	Improve a seal; Establish measures for dust prevention.
Rust generation	<ul style="list-style-type: none"> <li>•Rust</li> <li>- Caused by the loss of oil film or the contact of an exposed part with water, acid, and alkali.</li> <li>In particular, when cooling water flows in a block, it degrades lubrication and causes rust. Early flaking arises due to concentrated stress.</li> </ul>	Intrusion of cooling water	Apply surface treatment for rust prevention; Improve seal performance; Replace a lubricant; replace a coolant; Refill a lubricant; Shorten a refilling cycle of lubricant.
		High humidity	Apply surface treatment for rust prevention; Improve environments.
		Poor handling	Improve a storage place; Reinforce sealing treatment; Apply a sufficient amount of rust preventive oil.



**WON**  
LINEAR MOTION SYSTEM

# Crossed Roller Bearing

## Contents

<b>1</b>	Structure and Features of Crossed Roller Bearing	
	1. Structure.....	116
	2. Features.....	116
	3. Use.....	116
<b>2</b>	Types of Crossed Roller Bearing	
	1. CB Series for Revolving Inner Ring	
	.....	117
	2. CH Series with High Stiffness	
	.....	117
	3. CA Series for Slim Revolving Inner Ring	
	.....	118
	4. Customized Special Type CS Series	
	.....	118
<b>3</b>	Selection of Crossed Roller Bearing	
	1. Overview.....	119
	2. Procedure.....	119
<b>4</b>	Life Calculation	
	1. Rating life (L).....	120
	2. Life calculation under heaving operation	
	condition.....	121
	3. Static safety factor ( $f_s$ ).....	121
	4. Static equivalent radial load ( $P_o$ ).....	122
	5. Static equivalent radial load ( $P_o$ ).....	122
	6. Load factor ( $f_w$ ).....	123
	7. Temperature factor ( $f_t$ ).....	123
<b>5</b>	Load Rating	
	1. Basic dynamic load rating.....	123
	2. Basic static load rating.....	123
<b>6</b>	Permissible RPM.....	123
<b>7</b>	Lubrication.....	124
<b>8</b>	Cautions in Designing Compression Plate and Housing	
	1. Housing design for installation.....	124
	2. Tap for separation.....	124
	3. Installation and assembly.....	125
	4. Selection of compression flange and bolt	
	.....	125
<b>9</b>	Fitting.....	127
<b>10</b>	Precision Specification of Crossed Roller Bearing.....	128
<b>11</b>	Precision Specification of WUP-class Series	
	1. Rotational precision of WUP-class series	
	(example).....	132
	2. Precision specification.....	132
<b>12</b>	Radial Clearance.....	132
<b>13</b>	Dimensions of Crossed Roller Bearing	
	1. CB Series.....	134
	2. CH Series.....	136
	3. CA Series.....	138
<b>14</b>	Precautions for Handling Crossed Roller Bearing.....	139



# I Structure and Features of WON Crossed Roller Bearing

## I. Structure

WON Crossed Roller Bearing has the structure in which a roller as a rolling element is crossed at right angles with the rolling surface with the V-grooved inner ring and outer ring. A spacer-type retainer assembled between rollers prevents the collision and friction of rollers, and the increase in rotational torque. The device has an easy-to-use compact structure.

## 2. Features

In the rolling surface of the inner and outer rings of a crossed roller bearing, rollers are assembled. Therefore, the device reduces the elastic displacement by external load, and bears all complex loads, such as radial load, axial load, and moment load, at the same time. Since it adopts a spacer retainer, it avoids inclined surface of a roller, uneven wear caused by uneven contact, or hitching. Therefore, the product with high precision and high rigidity implements smooth rotary motion, and support preload adjustment differently depending on service conditions.

## 3. Use

This product is mainly usable in an environment that needs complex loads, high rigidity and rotational precision. It is applied to various types of equipment, such as industrial robot, machine tool index table, ATC, medical equipment, precise alignment stage, semiconductor manufacture equipment, and DD motor.

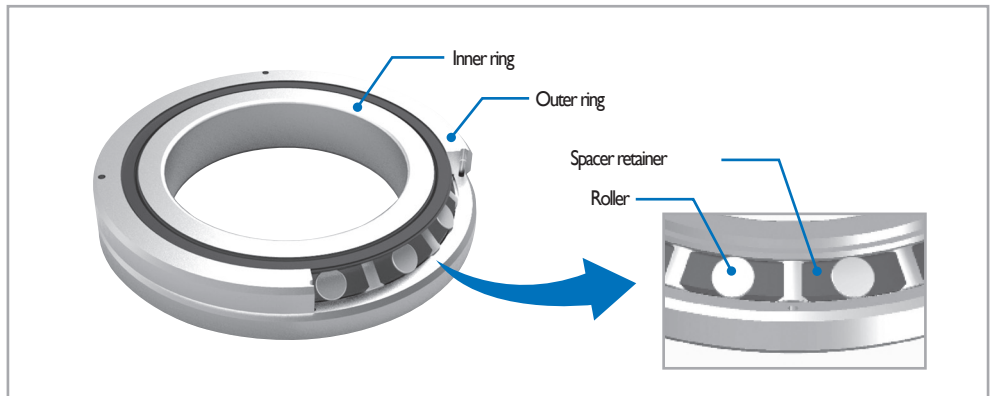

Figure I. Structure of Crossed Roller Bearing

## 2 Types of Crossed Roller Bearing

### 1. CB Series for Revolving Inner Ring

- 1) The inner ring of a crossed roller bearing has an integral type, and its outer ring is separable into upper and lower parts that are bolted for easy handling.
- 2) This model is mainly applied to the parts that needs the rotational precision of its inner ring, such as the index table of machine tool, or the joint or turning part of industrial robot.



### 2. CH Series with High Stiffness

- 1) The inner and outer rings of a crossed roller bearing have an integral type, so that the device has a small installation error. In addition, this model with high precision and high rigidity secures stablerotational precision.
- 2) This model is used in an environment where its inner and outer rings need to be rotated simultaneously or individually



### 3. CA Series for Slim Revolving Inner Ring

- 1) As a slim compact type, this model has minimum thickness of its inner and outer rings. Its inner ring has an integral type, and its outer ring is separable into upper and lower parts that are bolted for easy handling.
- 2) This model is mainly applied to the parts that needs the rotational precision of its inner ring and need to become light weight and small, such as the joint or turning part of industrial robot.



### 4. Customized Special Type CS Series

- 1) This is a customized model. If you need a special type in terms of the shape, size, material, and specification of the inner and outer rings, please contact WON ST.

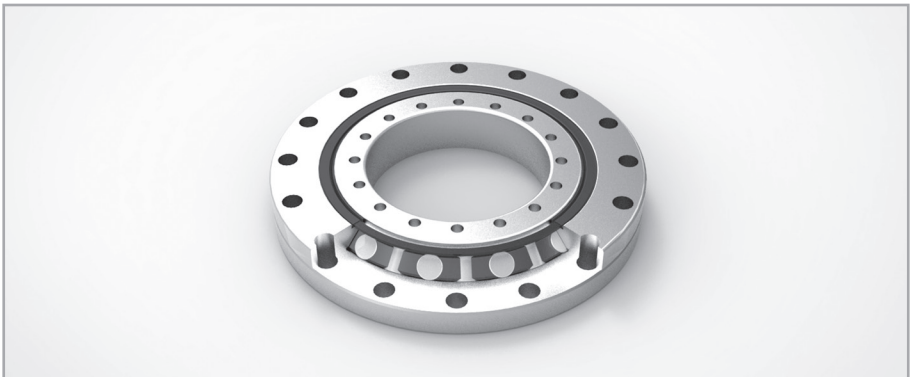









### 3 Selection of Crossed Roller Bearing

#### 1. Overview

To select a crossed roller bearing, it is necessary to identify the details of requirements, prioritize them, and then choose the one that meets the service conditions.

#### 2. Procedure

- |   |                                |   |
|---|--------------------------------|---|
| 1 | Determine service conditions   |  The equipment to be used, requirements, service environments, precision, rigidity, life, and others         |
| 2 | Select a type                  |  Integral type, Inner ring separation type, Outer ring separation type, General type, High rigidity type     |
| 3 | Calculate load                 |  Calculate radial load, axial load, moment load, and dynamic equivalent load                                 |
| 4 | Calculate rated service life   |  Calculate a rated service life  |
| 5 | Calculate static safety factor |  Calculate a static safety factor in consideration of the characteristics of equipment, external load, etc. |
| 6 | Determine rigidity and preload |  Determine clearance and preload values in consideration of motion conditions, rotational precision, etc.  |
| 7 | Determine precision level      |  Determine a level of precision in consideration of rotational precision and assembly precision.           |
| 8 | Determine lubrication          |  Determine oil, grease, or a special lubricant.  |
| 9 | Complete selection             |   |



## 4 Life Calculation

### I. Rated service life (L)

It is possible to calculate the basic rated life of cross roller bearing in the following formula.

$$L = \left( \frac{f_T \cdot C}{f_w \cdot P_c} \right)^{\frac{10}{3}} \times 10^6$$

Service life time

$$L_h = \frac{L}{60 \times N}$$

L : Rated service life

C : Basic dynamic load rating(N)

P<sub>c</sub> : Dynamic equivalent radial load(N)

f<sub>T</sub> : Temperature factor

f<sub>w</sub> : Load factor

L<sub>h</sub> : Service life time(h)

N : RPM(rpm)

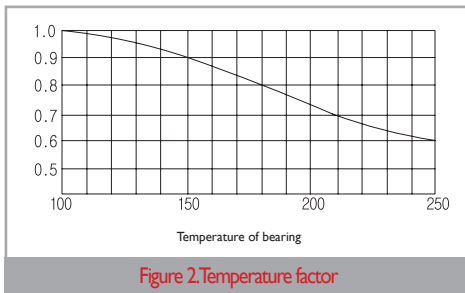

Note: Usually, workable temperature is 80°C or below. If above, please contact WON ST.

## 2. Life calculation under heaving operation condition

Service life of a bearing under heaving operation condition is calculated as follows.

$$L_{0c} = \frac{90}{\square} \left( \frac{C}{P_c} \right)^P$$

$L_{0c}$  : rated service life  $10^6$  cycle  
indicated in heaving frequency  
of the bearing under heaving operation

$\square$  : heaving angle (See Fig.3.)

$P_c$  : dynamic equivalent radial load

- $\square$  If  $\varnothing$  is small, it is hard to generate an oil film on the contact surface between the raceway surface and a rotating body. In addition, it may cause corrosion.

In case of heaving operation

Service life time

$$L_h = \frac{360 \times L}{2 \times \square \times n_o \times 60}$$

$L_h$  : Service life time (h)

$\square$  : Heaving angle (deg)

( $\square$  See the figure on the right.)

$n_o$  : Number of reciprocating motions (min-1)

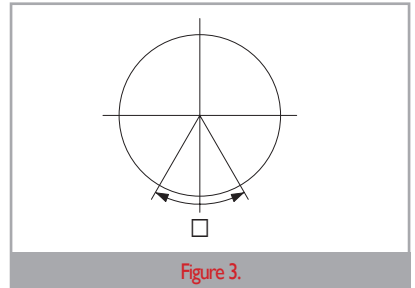

## 3. Static safety factor (fs)

Static safety factor ( $f_s$ ) of a crossed roller bearing is calculated as follows. For the general static safety factor, see Table I.

$$f_s = \frac{C_0}{P_0}$$

$f_s$  : static safety factor

$C_0$  : basic static load rating (N)

$P_0$  : static equivalent radial load (maximum load) (N)

Table I. Static safety factor ( $f_s$ )

Working condition	Lower limit of $f_s$
High rotational precision is required.	$\geq 3$
Under normal operation condition	$\geq 2$
Almost no rotation and no significance of smooth operation under normal operation condition	$\geq 1$

## 4. Static equivalent radial load ( $P_0$ )

Static equivalent radial load of a crossed roller bearing is calculated in the following formula.

$$P_0 = F_r + \frac{2M}{D_{PW}} + 0.44 F_a$$

$P_0$  : Static equivalent radial load (N)

$F_r$  : Radial load (N)

$F_a$  : Axial load (N)

$M$  : Moment (N·mm)

$D_{PW}$  : Roller set pitch diameter ( $D_{PW} \square \frac{d+D}{2}$ )

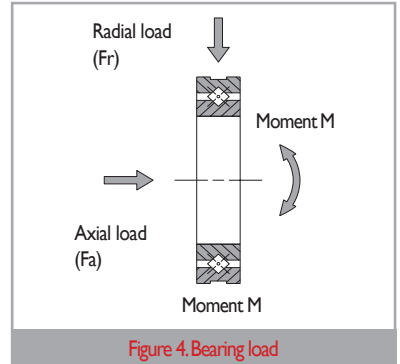

## 5. Dynamic equivalent radial load ( $P_c$ )

Dynamic equivalent radial load of a crossed roller bearing is calculated in the following formula.

$$P_c = X \left( F_r + \frac{2M}{D_{PW}} \right) + Y F_a$$

$P_c$  : Dynamic equivalent radial load (N)

$F_r$  : Radial load (N)

$F_a$  : Axial load (N)

$M$  : Moment (N·mm)

$X$  : Radial load factor (See Table 2.)

$Y$  : Axial load factor (See Table 2.)

$D_{PW}$  : Roller set pitch diameter ( $D_{PW} \square \frac{d+D}{2}$ )

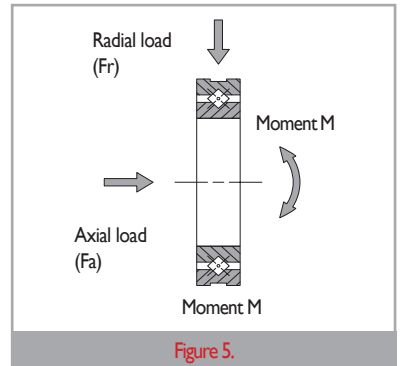

Table 2. Radial load factor and axial load factor

Classification	X	Y
$\frac{F_a}{F_r + 2M/D_{PW}} \leq 1.5$	1	0.45
$\frac{F_a}{F_r + 2M/D_{PW}} > 1.5$	0.67	0.67

## 6. Load factor ( $f_w$ )

When a crossed roller bearing is used, the load imposed on the bearing by vibration and impacts in operation is often greater than the calculated load. To select a crossed roller bearing, it is required to take into account the load factor values in the table shown below.

Table 3. Load factor ( $f_w$ )

Load condition	$f_w$		
Smooth operation condition without impacts	1	~	1.2
Normal operation condition	1.2	~	1.5
The operation condition with both vibration load and impact load	1.5	~	3

## 7. Temperature factor ( $f_t$ )

Temperature factor is presented in the following graph.

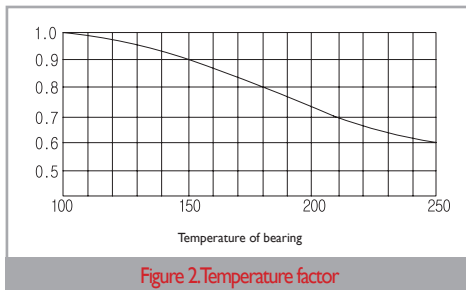

Figure 2. Temperature factor

Note: Usually, workable temperature is 80°C or below. If above, please contact WON ST

## 5 Load rating

### 1. Basic dynamic load rating ( $C$ )

It refers to the radial load with a constant size and direction, which makes it possible to meet the condition where over 90% in the group of multiple crossed roller bearings with the same model have no flaking and can rotate a million times.

### 2. Basic static load rating ( $C_0$ )

It refers to the static radial load that imposes a certain level of contact stress on the raceway surface with the maximum load and on the center of the contact part of a rotating body in a crossed roller bearing.

## 6 Permissible RPM

For the permissible RPM of a crossed roller bearing, see the table below.  
A permissible RPM depends on assembly or service conditions.

Table 4. Permissible RPM of crossed roller bearing (dm\*n)

Bearing	Type	Seal	Grease lubrication	Oil lubrication
Bearing		No seal	75,000	150,000
Spacer retainer		Seals on the both sides	60,000	-

$$dm \cdot n = dm \times n$$

dm : The mean value of inside and outside dimeters (mm)

n : Revolution count (rpm)

## 7 Lubrication

A crossed roller bearing is commonly lubricated with grease. An oil inlet of the inner ring and outer ring is used for grease supply. A crossed roller bearing with double-sided seal mounting type is filled with Albania EP2 grease. If a bearing is not filled with a lubricant, please fill it with the grease or oil suitable for service conditions before use. Without lubrication, it is possible to make the rolling surface worn out more and shorten of a bearing life.

## 8 Cautions in Designing Compression Plate and Housing

A crossed roller bearing is compact and slim. It is required to evaluate the rigidity of a pressure plate or housing plate and the torque of bolts in the process of designing an installation part. In the case of poor rigidity, it is impossible to assemble the inner and outer rings of a bearing evenly and tightly, and the bearing can be deformed in moment load. In such deformation, a roller fails to make contact uniform and thus performance of the bearing is degraded significantly.

### 1. Housing design for installation

Housing thickness should be at least 60% of cross-section height of a bearing.

$$T = \frac{D-d}{2} \times 0.6 \text{ or more}$$

T : Housing thickness

D : The outside diameter of the outer ring

d : The outside diameter of the inner ring

### 2. Tap for separation

If a separation tap is applied to a design, it is easy to separate the inner and outer rings without any damage to a bearing.

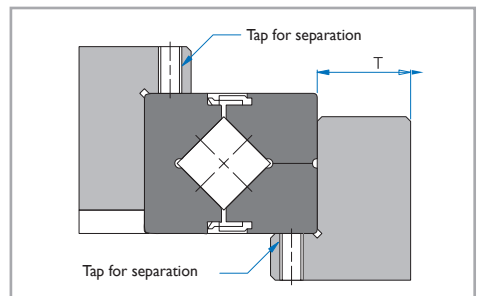
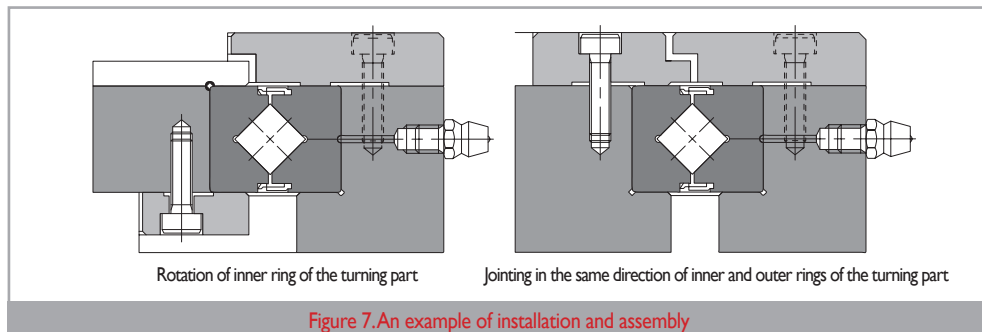

Figure 6.

### 3. Installation and assembly

For installation and assembly, see the following figure.



### 4. Selection of compression flange and bolt

The more numbers of the fastening bolts for compression, the more stable. Bolts are arranged in the equimultiples as shown in Table 5. For the thickness (F) and gap (S) of the flange for compression, see the following table of dimensions

$$F = B \times 0.5 \sim B \times 1.2$$

$$H = B_{0.1}^0$$

$$S = 0.5\text{mm}$$

To prevent a flange for compression from being loosened, it is required to make firm connection in an appropriate torque level. If a shaft or housing is made of a light alloy material, use steel. For general heavy or light steel, see the following table.

Table 5. Number of compression bolts and bolt size

Unit:mm

external diameter of outer ring		No. of bolts	Bolt size
Above	Below		
-	100	8 or more	M3 ~ M5
100	200	12 or more	M4 ~ M8
200	300	16 or more	M5 ~ M12

Table 6. Maximum clamping torque of bolts

Unit:N·m

Bolt No.	Clamping torque	Bolt No.	Clamping torque
M3	2	M8	30
M4	4	M10	70
M5	9	M12	120
M6	14	-	-

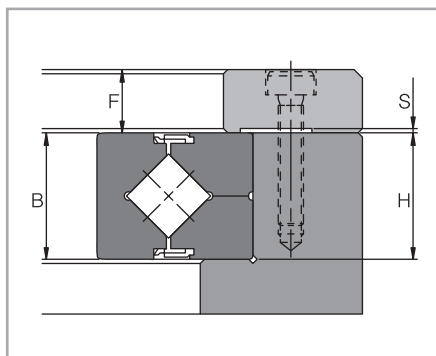

Figure 8.

## 5. Assembly procedure for installation

The assembly procedure of a crossed roller bearing is as follows.

### 1. Preliminary check before mounting

Wash a housing or other assembly parts clearly and check if they have any scratch or sharp edge.

### 2. Axis or housing assembly

Since a bearing is slim, it can be easily inclined in the process of assembly. Make it balanced horizontally with the use of a plastic hammer, and then hammer the cylinder of the outer ring gradually and insert it. Carefully hammer it until the part is set in the contact surface completely.

### 3. Compression-flange mounting

- 1) Mount a flange for compression. Check a position for bolt fastening by shaking the flange before assembly.
- 2) Check that a bolt is positioned well in a hole before fastening the bolt.
- 3) The bolt fastening process is comprised of 2 to 5 steps from temporary fastening to complete fastening. If the inner ring and outer ring are separated from each other, rotate the integral axis gently and slowly in order to secure an assembly position, and then fasten a bolt in 2 to 5 steps.

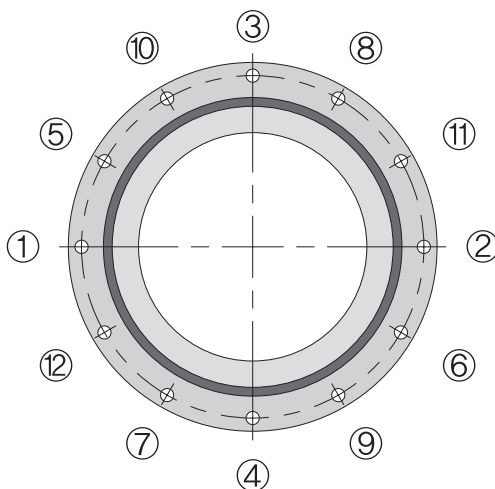

Figure 9.

## 9 Fitting

For fitting, see the following table

Table 7. Recommended fitting in normal load

Radial internal clearance	Tolerance range class			
	Load fixed to inner ring		Load fixed to outer ring	
	Shaft	Housing bore	Shaft	Housing bore
G <sub>2</sub> clearance	h5	H7	g5	J7 <sup>(1)</sup>
G <sub>1</sub> clearance	j5	H7	g5	J7 <sup>(1)</sup>

Note<sup>(1)</sup> It is recommended to fit to a small edge according to measured value of a bearing.

Table8. Recommended fitting for the normal clearance of a slim type

Inside diameter of bearing (d)	Load fixed to inner ring				Load fixed to outer ring			
	Shaft		Housing bore		Shaft		Housing bore	
	Max.	Min.	Max.	Min.	Max.	Min.	Max.	Min.
50	+15	0	+13	0	-15	-30	-13	-25
60	+15	0	+13	0	-15	-30	-13	-25
70	+15	0	+15	0	-15	-30	-15	-30
80	+20	0	+15	0	-20	-40	-15	-30
90	+20	0	+15	0	-20	-40	-15	-30
100	+20	0	+15	0	-20	-40	-15	-30
110	+20	0	+20	0	-20	-40	-20	-40
120	+25	0	+20	0	-25	-50	-20	-40
130	+25	0	+25	0	-25	-50	-25	-50
140	+25	0	+25	0	-25	-50	-25	-50
150	+25	0	+25	0	-25	-50	-25	-50
160	+25	0	+25	0	-25	-50	-25	-50
170	+25	0	+30	0	-25	-50	-30	-60
180	+30	0	+30	0	-30	-60	-30	-60
190	+30	0	+30	0	-30	-60	-30	-60
200	+30	0	+30	0	-30	-60	-30	-60



## 10 Precision Specification of Crossed Roller Bearing

Precision of a crossed roller bearing and dimensional tolerance are calculated with the dimensions described in Table 9 to Table 18.

Table 9. Rotational precision of the inner ring of CH Series

Unit : □

Model No.	Inner ring radial runout tolerance			Inner ring axis runout tolerance		
	Precision	Super precision	Ultra precision	Precision	Super precision	Ultra precision
	P5	P4	P2	P5	P4	P2
CH42	4	3	2.5	4	3	2.5
CH66	5	4	2.5	5	4	2.5
CH85	5	4	2.5	5	4	2.5
CHI24	5	4	2.5	5	4	2.5
CHI48	6	5	2.5	6	5	2.5
CHI78	6	5	2.5	6	5	2.5
CH228	8	6	5	8	6	5
CH297	10	8	5	10	8	5
CH445	15	12	7	15	12	7

Note<sup>(1)</sup>: Standard rotational precision of CH series is P5.

Table 10. Rotational precision of the outer ring of CH Series

Unit : □

Model No.	Inner ring radial runout tolerance			Inner ring axis runout tolerance		
	Precision	Super precision	Ultra precision	Precision	Super precision	Ultra precision
	P5	P4	P2	P5	P4	P2
CH42	8	5	4	8	5	4
CH66	10	6	5	10	6	5
CH85	10	6	5	10	6	5
CHI24	13	8	5	13	8	5
CHI48	15	10	7	15	10	7
CHI78	15	10	7	15	10	7
CH228	18	11	7	18	11	7
CH297	20	13	8	20	13	8
CH445	25	16	10	25	16	10

Note<sup>(1)</sup>: Standard rotational precision of CH series is P5.

Table 11. Rotational precision of the inner ring of CB Series

Unit : □

Nominal dimension (mm) of the inside diameter (d) of bearing		Inner ring radial runout tolerance					Inner ring axis runout tolerance				
		0	PE6	PE5	PE4	PE2	0	PE6	PE5	PE4	PE2
			P6	P5	P4	P2		P6	P5	P4	P2
Above	Below										
18	30	13	8	4	3	2.5	13	8	4	3	2.5
30	50	15	10	5	4	2.5	15	10	5	4	2.5
50	80	20	10	5	4	2.5	20	10	5	4	2.5
80	120	25	13	6	5	2.5	25	13	6	5	2.5
120	150	30	18	8	6	2.5	30	18	8	6	2.5
150	180	30	18	8	6	5	30	18	8	6	5
180	250	40	20	10	8	5	40	20	10	8	5
250	315	50	25	13	10	(6)	50	25	13	10	(6)
315	400	60	30	15	12	(7)	60	30	15	12	(7)
400	500	65	35	18	14	(9)	65	35	18	14	(9)
500	630	70	40	20	16	(10)	70	40	20	16	(10)
630	800	80	(45)	(23)	(18)	(11)	80	(45)	(23)	(18)	(11)
800	1000	90	(50)	(25)	(20)	(12)	90	(50)	(25)	(20)	(12)

Table 12. Rotational precision of the inner ring of CA Series

Unit : □

Nominal dimension (mm) of the inside diameter (d) of bearing		Radial run-out Allowable value of axial run-out
Above	Below	
40	65	13
65	80	15
80	100	15
100	120	20
120	140	25
140	180	25
180	200	30

Table 13. Dimensional tolerance of the inside diameter of bearing

Unit : □

Nominal dimension (mm) of the inside diameter (d) of bearing		Tolerance of dm <sup>Note (2)</sup>							
Above	Below	0,P6,P5,P4,P2,WVUP		PE6		PE5		PE4, PE2	
		Max.	Min.	Max.	Min.	Max.	Min.	Max.	Min.
18	30	0	-10	0	-8	0	-6	0	-5
30	50	0	-12	0	-10	0	-8	0	-6
50	80	0	-15	0	-12	0	-9	0	-7
80	120	0	-20	0	-15	0	-10	0	-8
120	150	0	-25	0	-18	0	-13	0	-10
150	180	0	-25	0	-18	0	-13	0	-10
180	250	0	-30	0	-22	0	-15	0	-12
250	315	0	-35	0	-25	0	-18	-	-
315	400	0	-40	0	-30	0	-23	-	-
400	500	0	-45	0	-35	-	-	-	-
500	630	0	-50	0	-40	-	-	-	-
630	800	0	-75	0	-	-	-	-	-
800	1000	0	-100	-	-	-	-	-	-

Note<sup>(1)</sup>: Standard precision of the inside diameter of CH series is class 0. For higher precision, please contact WON ST.

Note<sup>(2)</sup>: dm is the mean value between the max diameter and min diameter of the 2-point measurement values of bearing inside diameter.

Note<sup>(3)</sup>: In case of no indication of precision class, the highest of the low precision classes is applied.

Table 14. Dimensional tolerance of the outside diameter of bearing

Unit : □

Nominal dimension (mm) of the inside diameter (d) of bearing		Tolerance of dm <sup>Note (2)</sup>							
Above	Below	0,P6,P5,P4,P2,WUP		PE6		PE5		PE4, PE2	
		Max.	Min.	Max.	Min.	Max.	Min.	Max.	Min.
30	50	0	-11	0	-9	0	-7	0	-6
50	80	0	-13	0	-11	0	-9	0	-7
80	120	0	-15	0	-13	0	-10	0	-8
120	150	0	-18	0	-15	0	-11	0	-9
150	180	0	-25	0	-18	0	-13	0	-10
180	250	0	-30	0	-20	0	-15	0	-11
250	315	0	-35	0	-25	0	-18	0	-13
315	400	0	-40	0	-28	0	-20	0	-15
400	500	0	-45	0	-33	0	-23	-	-
500	630	0	-50	0	-38	0	-28	-	-
630	800	0	-75	0	-45	0	-35	-	-
800	1000	0	-100	-	-	-	-	-	-

Note<sup>(1)</sup>: Standard precision of the inside diameter of CH series is class 0. For higher precision, please contact WON ST.

Note<sup>(2)</sup>: dm is the mean value between the max diameter and min diameter of the 2-point measurement values of bearing outside diameter

Note<sup>(3)</sup>: In case of no indication of precision class, the highest of the low precision classes is applied.

Table 15. Tolerance of the inner &amp; outer ring width of CB Series

Unit : □

Model No.	Tolerance of BI	
	Max.	Min.
CH42	0	-75
CH66	0	-75
CH85	0	-75
CH124	0	-75
CH148	0	-75
CH178	0	-100
CH228	0	-100
CH297	0	-100
CH445	0	-150

Table 15. Tolerance of the inner &amp; outer ring width of CB Series

Unit : □

Nominal dimension (mm) of the inside diameter (d) of bearing		Tolerance of BI		Tolerance of BI	
		Applied to the inner ring of CB		Applied to the outer ring of CB	
Above	Below	Max.	Min.	Max.	Min.
18	30	0	-75	0	-100
30	50	0	-75	0	-100
50	80	0	-75	0	-100
80	120	0	-75	0	-100
120	150	0	-100	0	-120
150	180	0	-100	0	-120
180	250	0	-100	0	-120
250	315	0	-120	0	-150
315	400	0	-150	0	-200
400	500	0	-150	0	-200
500	630	0	-150	0	-200
630	800	0	-150	0	-200
800	1000	0	-300	0	-400

## II Precision Specification of WUP-class Series

### I. Rotational precision of WUP-class series (example)

WUP-class Series has higher rotational precision than those of ISO Class2, KS 2, DIN P2,AFBMA ABCE9, and JIS2.

### 2. Precision specification

The runout precision of CH, CB and WUP-class crossed roller bearing series is based on the Table 17 and Table 18.

Table 17. Runout precision of CH and WUP-class series Unit :

Model No.	Runout precision of the inner ring of CH series		Runout precision of the outer ring of CH series	
	Radial runout tolerance	Axis runout tolerance	Radial runout tolerance	Axis runout tolerance
CH42	2	2	3	3
CH66	2	2	3	3
CH85	2	2	3	3
CH124	2	2	3	3
CH148	2	2	4	4
CH178	2	2	4	4
CH228	2.5	2.5	4	4
CH297	3	3	5	5
CH445	4	4	7	7

Table 18. Runout precision of CB and WUP-class series Unit :

Nominal dimensions (mm) of the inner diameter (d) and outside diameter (D)		Runout precision of the inner ring of CB series	
Above	Below	Radial runout tolerance	Axis runout tolerance
80	180	2.5	2.5
180	250	3	3
250	315	4	4
315	400	4	4
400	500	5	5
500	630	6	6
630	800	-	-

## 12 Radial Clearance

The radial clearance of CH, CB, and CA series is shown in the following tables

Table 19. Radial clearance of CH series Unit :

Model No.	G <sub>3</sub>		G <sub>2</sub>	
	Starting torque (N·m)		Radial clearance (□)	
	Min.	Max.	Min.	Max.
CH42	0.1	0.5	0	25
CH66	0.3	2.2	0	30
CH85	0.4	3	0	40
CH124	1	6	0	40
CH148	1	10	0	40
CH178	3	15	0	50
CH228	5	20	0	60
CH297	10	35	0	70
CH445	20	55	0	100

Note: G<sub>3</sub> clearance of CH series is controlled by starting torque, and the starting torque of G<sub>3</sub> clearance has no seal resistance.

Table 20. Radial clearance of CB and WUP-class series Unit :

Pitch circle diameter of roller (dp) (mm)		G <sub>3</sub>		G <sub>2</sub>	
Above	Below	Min.	Max.	Min.	Max.
120	160	-10	0	0	40
160	200	-10	0	0	50
200	250	-10	0	0	60
250	280	-15	0	0	80
280	315	-15	0	0	100
315	355	-15	0	0	110
355	400	-15	0	0	120
400	500	-20	0	0	130
500	560	-20	0	0	150
560	630	-20	0	0	170
630	710	-20	0	0	190

Table 21. Radial clearance of CB series

Unit : □

Pitch circle diameter of roller (dp) (mm)		G <sub>3</sub>		G <sub>2</sub>		G <sub>1</sub>	
Above	Below	Min.	Max.	Min.	Max.	Min.	Max.
18	30	-8	0	0	15	15	35
30	50	-8	0	0	25	25	50
50	80	-10	0	0	30	30	60
80	120	-10	0	0	40	40	70
120	140	-10	0	0	40	40	80
140	160	-10	0	0	40	40	90
160	180	-10	0	0	50	50	100
180	200	-10	0	0	50	50	110
200	225	-10	0	0	60	60	120
225	250	-10	0	0	60	60	130
250	280	-15	0	0	80	80	150
280	315	-15	0	30	100	100	170
315	355	-15	0	30	110	110	190

Unit : □

Pitch circle diameter of roller (dp) (mm)		G <sub>3</sub>		G <sub>2</sub>		G <sub>1</sub>	
Above	Below	Min.	Max.	Min.	Max.	Min.	Max.
355	400	-15	0	30	120	120	210
400	450	-20	0	30	130	130	230
450	500	-20	0	30	130	130	250
500	560	-20	0	30	150	150	280
560	630	-20	0	40	170	170	310
630	710	-20	0	40	190	190	350
710	800	-30	0	40	210	210	390
800	900	-30	0	40	230	230	430
900	1000	-30	0	50	260	260	480
1000	1120	-30	0	60	290	290	530
1120	1250	-30	0	60	320	320	580
1250	1400	-30	0	70	350	350	630

Table 22. Radial clearance of CA series

Unit : □

Pitch circle diameter of roller (dp) (mm)		G <sub>3</sub>		G <sub>2</sub>	
Above	Below	Min.	Max.	Min.	Max.
50	80	-8	0	0	15
80	120	-8	0	0	15
120	140	-8	0	0	15
140	160	-8	0	0	15
160	180	-10	0	0	20
180	200	-10	0	0	20
200	225	-10	0	0	20

## 13 Dimensions of Crossed Roller Bearing

### I. CB Series

Composition of Model Name & Number

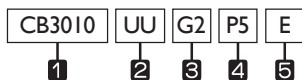

- 1 Model No.
- 2 No symbol- No seal / UU- Two-side seal / U- One-side seal
- 3 Symbol of clearance: G<sub>i</sub>-Normal preload / G<sub>l</sub>-Light preload / G<sub>h</sub>-Heavy preload / G<sub>s</sub>-Special preload
- 4 Symbol of precision: No symbol-Moderate / H6-High / P4-Super Precision / P2-Ultra Precision
- 5 No symbol-Standard product / E-special specification

- Standard type, The structure inner ring rotation and outer ring separation

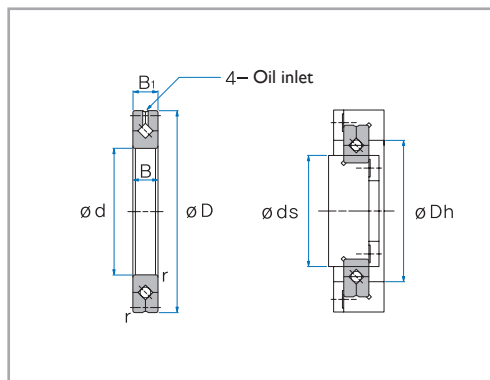

Unit : mm

Shaft diameter	Model No.	Major dimensions							Assembly dimensions		Basic load rating (radial)		Mass kg
		Inner diameter d	Outside diameter D	Pitch circle diameter of roller dp	Width B B <sub>1</sub>	Oil inlet		r min	ds max	Dh min	C kN	C <sub>0</sub> kN	
						a	b						
20	CB 2008	20	36	27	8	2	0.8	0.5	23.5	30.5	3.23	3.1	0.04
25	CB 2508	25	41	32	8	2	0.8	0.5	28.5	35.5	3.63	3.83	0.05
30	CB 3010	30	55	41.5	10	2.5	1	0.6	37	47	7.35	8.36	0.12
35	CB 3510	35	60	46.5	10	2.5	1	0.6	41	51.5	7.64	9.12	0.13
40	CB 4010	40	65	51.5	10	2.5	1	0.6	47.5	57.5	8.33	10.6	0.16
45	CB 4510	45	70	56.5	10	2.5	1	0.6	51	61.5	8.62	11.3	0.17
50	CB 5013	50	80	64	13	2.5	1.6	0.6	57.4	72	16.7	20.9	0.27
60	CB 6013	60	90	74	13	2.5	1.6	0.6	68	82	18	24.3	0.3
70	CB 7013	70	100	84	13	2.5	1.6	0.6	78	92	19.4	27.7	0.35
80	CB 8016	80	120	98	16	3	1.6	0.6	91	111	30.1	42.1	0.7
90	CB 9016	90	130	108	16	3	1.6	1	98	118	31.4	45.3	0.75
100	CB 10016	100	140	119.3	16	3.5	1.6	1	109	129	31.7	48.6	0.83
	CB 10020		150	123	20	3.5	1.6	1	113	133	33.1	50.9	1.45
110	CB 11012	110	135	121.8	12	2.5	1	0.6	117	127	12.5	24.1	0.4
	CB 11015		145	126.5	15	3.5	1.6	0.6	122	136	23.7	41.5	0.75
	CB 11020		160	133	20	3.5	1.6	1	120	143	34	54	1.56

Unit : mm

Shaft diameter	Model No.	Major dimensions							Assembly dimensions		Basic load rating (radial)		Mass
		Inner diameter d	Outside diameter D	Pitch circle diameter of roller dp	Width B B <sub>1</sub>	Oil inlet		r min	ds max	Dh min	C kN	C <sub>0</sub> kN	kg
						a	b						
120	CB 12016	120	150	134.2	16	3.5	1.6	0.6	127	141	24.2	43.2	0.72
	CB 12025		180	148.7	25	3.5	2	1.5	133	164	66.9	100	2.62
130	CB 13015	130	160	144.5	15	3.5	1.6	0.6	137	152	25	46.7	0.72
	CB 13025		190	158	25	3.5	2	1.5	143	174	69.5	107	2.82
140	CB 14016	140	175	154.8	16	2.5	1.6	1	147	162	25.9	50.1	1
	CB 14025		200	168	25	3.5	2	1.5	154	185	74.8	121	2.96
150	CB 15013	150	180	164	13	2.5	1.6	0.6	157	172	27	53.5	0.68
	CB 15025		210	178	25	3.5	2	1.5	164	194	76.8	128	3.16
	CB 15030		230	188	30	4.5	3	1.5	173	211	100	156	5.3
160	CB 16025	160	220	188.6	25	3.5	2	1.5	173	204	81.7	135	3.14
170	CB 17020	170	220	191	20	3.5	1.6	1.5	184	198	29	62.1	2.21
180	CB 18025	180	240	210	25	3.5	2	1.5	195	225	84	143	3.44
190	CB 19025	190	240	211.9	25	3.5	1.6	1	202	222	41.7	82.9	2.99
200	CB 20025	200	260	230	25	3.5	2	2	215	245	84.2	157	4
	CB 20030		280	240	30	4.5	3	2	221	258	114	200	6.7
	CB 20035		295	247.7	35	5	3	2	225	270	151	252	9.6
220	CB 22025	220	280	250.1	25	3.5	2	2	235	265	92.3	171	4.1
240	CB 24025	240	300	269	25	3.5	2	2.5	256	281	68.3	145	4.5
250	CB 25025	250	310	277.5	25	3.5	2	2.5	265	290	69.3	150	5
	CB 25030		330	287.5	30	4.5	3	2.5	269	306	126	244	8.1
	CB 25040		355	300.7	40	6	3.5	2.5	275	326	195	348	14.8
300	CB 30025	300	360	328	25	3.5	2	2.5	315	340	76.3	178	5.9
	CB 30035		395	345	35	5	3	2.5	322	368	183	367	13.4
	CB 30040		405	351.6	40	6	3.5	2.5	326	377	212	409	17.2
350	CB 35020	350	400	373.4	20	3.5	1.6	2.5	363	383	54.1	143	3.9
400	CB 40035	400	480	440.3	35	5	3	2.5	422	459	156	370	14.5
	CB 40040		510	453.4	40	6	3.5	2.5	428	479	241	531	23.5
450	CB 45025	450	500	474	25	3.5	1.6	1	464	484	61.7	182	6.6
500	CB 50025	500	550	524.2	25	3.5	1.6	1	514	534	65.5	201	7.3
	CB 50040		600	548.8	40	6	3	2.5	526	572	239	607	26
	CB 50050		625	561.6	50	6	3.5	2.5	536	587	267	653	41.7
600	CB 60040	600	700	650	40	6	3	3	627	673	264	721	29
700	CB 70045	700	815	753.5	45	6	3	3	731	777	281	836	46
800	CB 80070	800	950	868.1	70	6	4	4	836	900	468	1330	105
900	CB 90070	900	1050	969	70	6	4	4	937	1001	494	1490	120



## 2. CH Series

### Composition of Model Name & Number

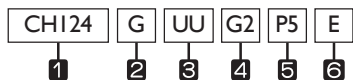

- 1 Model No.
- 2 Shape: **No symbol**-The same direction of counterbore / **G**-Opposite direction of counterbore/ **X**-inner ring tap hole
- 3 **No symbol**- No seal / **UU**- Two-side seal / **U**- One-side seal (one-side seal of the counterbore of outer ring)/**UT**-One-side seal (the opposite of the counterbore of outer ring)
- 4 Symbol of clearance: **G**-Normal preload / **G**-Light preload / **Gs**-Heavy preload / **Gs**-Special preload
- 5 Symbol of precision: **No symbol**-Moderate / **H6**-High / **P4**-Super Precision / **P2**-Ultra Precision
- 6 **No symbol**-Standard product / **E**-special specification

- High-rigidity type, Integral structure of the inner and outer rings

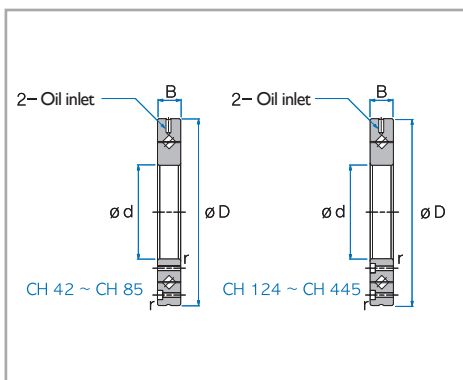

Unit : mm

Shaft diameter	Model No.	Major dimensions						Assembly dimensions		Basic load rating (radial)		Mass kg
		Inner diameter d	Outside diameter D	Pitch circle diameter of roller dp	Width B	Oil inlet		ds max	Dh min	C kN	C0 kN	
						d1	r min					
20	CH 42	20	70	41.5	12	3.1	0.6	37	47	7.35	8.35	0.29
35	CH 66	35	95	66	15	3.1	0.6	59	74	17.5	22.3	0.62
55	CH 85	55	120	85	15	3.1	0.6	79	93	20.3	29.5	1
80	CH 124(G)	80	165	124	22	3.1	1	114	134	33.1	50.9	2.6
	CH 124X											
90	CH 148(G)	90	210	147.5	25	3.1	1.5	133	162	49.1	76.8	4.9
	CH 148X											
115	CH 178(G)	115	240	178	28	3.1	1.5	161	195	80.3	135	6.8
	CH 178X											
160	CH 228(G)	160	295	227.5	35	6	2	208	246	104	173	11.4
	CH 228X											
210	CH 297(G)	210	380	297.3	40	6	2.5	272	320	156	281	21.3
	CH 297X											
350	CH 445(G)	350	540	445.4	45	6	2.5	417	473	222	473	35.4
	CH 445X											

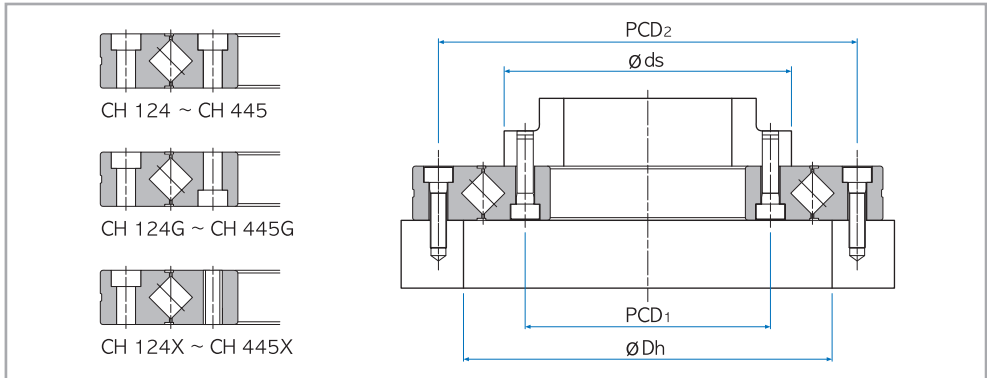

Unit : mm

Shaft diameter	Model No.	Inner ring		Outer ring	
		PCD <sub>1</sub>	Mounting hole	PCD <sub>2</sub>	Mounting hole
20	CH 42	28	6-M3 penetrated	57	6-ø3.4 penetrated, ø6.5 counterbore depth 3.3
35	CH 66	45	8-M4 penetrated	83	8-ø4.5 penetrated, ø8 counterbore depth 4.4
55	CH 85	65	8-M5 penetrated	105	8-ø5.5 penetrated, ø9.5 counterbore depth 5.4
80	CH 124(G)	97	10-ø5.5 penetrated, ø9.5 counterbore depth 5.4	148	10-ø5.5 penetrated, ø9.5 counterbore depth 5.4
	CH 124X		10-M5 penetrated		
90	CH 148(G)	112	12-ø9 penetrated, ø14 counterbore depth 8.6	187	12-ø9 penetrated, ø14 counterbore depth 8.6
	CH 148X		12-M8 penetrated		
115	CH 178(G)	139	12-ø9 penetrated, ø14 counterbore depth 8.6	217	12-ø9 penetrated, ø14 counterbore depth 8.6
	CH 178X		12-M8 penetrated		
160	CH 228(G)	184	12-ø11 penetrated, ø17.5 counterbore depth 10.8	270	12-ø11 penetrated, ø17.5 counterbore depth 10.8
	CH 228X		12-M10 penetrated		
210	CH 297(G)	240	16-ø14 penetrated, ø20 counterbore depth 13	350	16-ø14 penetrated, ø20 counterbore depth 13
	CH 297X		16-M12 penetrated		
350	CH 445(G)	385	24-ø14 penetrated, ø20 counterbore depth 13	505	24-ø14 penetrated, ø20 counterbore depth 13
	CH 445X		24-M12 penetrated		

### 3. CA Series

#### Composition of Model Name & Number

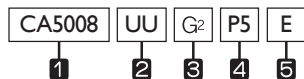

- 1** Model No.
- 2** No symbol- No seal / UU- Two-side seal / U- One-side seal
- 3** Symbol of clearance: G1-Normal preload / G2-Light preload / G3-Heavy preload / G5-Special preload
- 4** Symbol of precision: No symbol-Moderate / H6-High / P4-Super Precision / P2-Ultra Precision
- 5** No symbol-Standard product /E-special specification

- Slim type. The structure inner ring rotation and outer ring separation

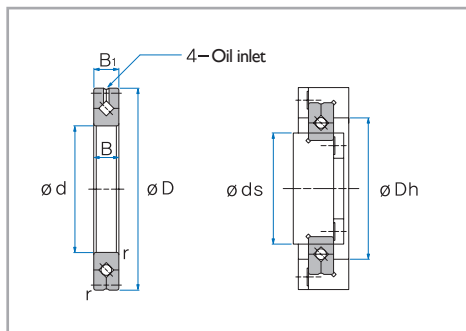

Unit : mm

Shaft diameter	Model No.	Major dimensions							Assembly dimensions		Basic load rating (radial)		Mass kg
		Inner diameter d	Outside diameter D	Pitch circle diameter of roller dp	Width B B1	Oil inlet		r <sub>min</sub>	ds (max)	Dh (min)	C kN	C <sub>0</sub> kN	
						a	b						
50	CA 5008	50	66	57	8	2	0.8	0.5	53.5	60.5	5.1	7.19	0.08
60	CA 6008	60	76	67	8	2	0.8	0.5	63.5	70.5	5.68	8.68	0.09
70	CA 7008	70	86	77	8	2	0.8	0.5	73.5	80.5	5.98	9.8	0.1
80	CA 8008	80	96	87	8	2	0.8	0.5	83.5	90.5	6.37	11.3	0.11
90	CA 9008	90	106	97	8	2	0.8	0.5	93.5	100.5	6.76	12.4	0.12
100	CA 10008	100	116	107	8	2	0.8	0.5	103.5	110.5	7.15	13.9	0.14
110	CA 11008	110	126	117	8	2	0.8	0.5	113.5	120.5	7.45	15	0.15
120	CA 12008	120	136	127	8	2	0.8	0.5	123.5	130.5	7.84	16.5	0.17
130	CA 13008	130	146	137	8	2	0.8	0.5	133.5	140.5	7.94	17.6	0.18
140	CA 14008	140	156	147	8	2	0.8	0.5	143.5	150.5	8.33	19.1	0.19
150	CA 15008	150	166	157	8	2	0.8	0.5	153.5	160.5	8.82	20.6	0.2
160	CA 16013	160	186	172	13	2.5	1.6	0.8	165	179	23.3	44.9	0.59
170	CA 17013	170	196	182	13	2.5	1.6	0.8	175	189	23.5	46.5	0.64
180	CA 18013	180	206	192	13	2.5	1.6	0.8	185	199	24.5	49.8	0.68
190	CA 19013	190	216	202	13	2.5	1.6	0.8	195	209	24.9	51.5	0.69
200	CA 20013	200	226	212	13	2.5	1.6	0.8	205	219	25.8	54.7	0.71

## 14 Precautions for Handling Crossed Roller Bearing

1. If the assembly part for installation fails to have sufficient rigidity, the contact part of the rollers has intensive stress that severely degrades the performance of a bearing. In an environment with large moment, it is required to evaluate the rigidity of housing and bolts in the process of design.
2. Some parts of a crossed roller bearing are made of special synthetic rubber and synthetic resin. For the use at above 80°C, please contact WONST.
3. It is required to manage dimensional tolerance of assembly parts according to standards in order to make the inner and outer rings in tight contact with the sides.
4. A crossed roller bearing may be damaged by its fall or hit. Any impact to the bearing may cause functional loss even if there is no damage to its appearance. Be careful to handle the product.
5. If foreign substances flow in a crossed roller bearing, they may cause its functional loss. It is required to take measures to prevent cutting chips or dust from intruding in the device.
6. A crossed roller bearing is already filled with lithium soap grease at the time of shipment. So, it can be used without refilling at the time of assembly. It is necessary to connect a lubrication hole with the oil inlet of the inner or outer ring. Regardless of rotation frequency, it is required to refill enough not for a lubricant to ooze out in the cycle of six months to one year.
7. Avoid lubricants with different thickeners or additives, if possible.
8. If you need to use the product in a place with impact or vibration load, in cleanroom, or in a special environment with vacuum, low temperature, or high temperature, please contact WON ST.



**WON**  
LINEAR MOTION SYSTEM

# Ball Spline Contents

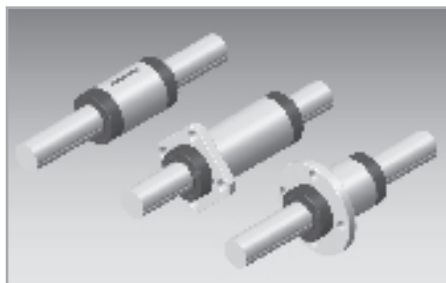

<b>1</b> Ball Spline	<b>6</b> Lubrication and Dust Proof	152
1. Structure and Features		142
2. Transmission of high torque		142
3. High load capacity and long life	<b>7</b> Assembly	152
7. Basic static rating torque ( $T_0$ )	2. High load capacity and long life	174
Basic static rating moment ( $T_M$ )	3. Torque transmission with	
	high precision	174
<b>4</b> Preload	4. High speed movement	
	and high speed rotation	174
	5. Product components	174
<b>5</b> Precision	6. Easy further processing	174

# WON Ball Spline

## 1. Structure and Features

WON Ball Spline consists of a nut and a shaft. The ball of the nut has a rolling linear motion along the groove of the precisely-ground spline shaft. The spline has the linear motion to deliver torque in the circumferential direction of the shaft. Based on one nut, the device exerts high performance in the radial direction, in an environment with vibration and impact load, in an environment that requires high positioning precision, or in an environment that needs high-speed motion.

## 2. Transmission of high torque

A spline groove is precisely ground in the shape close to a ball diameter. For this reason, if torque load is imposed on a shaft or nut, it is evenly applied to two rows of the ball in the torque load direction in the transmission of rotatory force.

## 3. High load capacity and long life

WON Ball Spline can be designed to be compact. It ensures high stability and long life in an environment with high load or torsional load.

## 4. Zero gap

Since a ball spline minimizes the gap of the rotational direction, and, if necessary, imposes preload on one spline nut to make clearance zero, it can have a small displacement value and obtain high rigidity and high positioning precision.

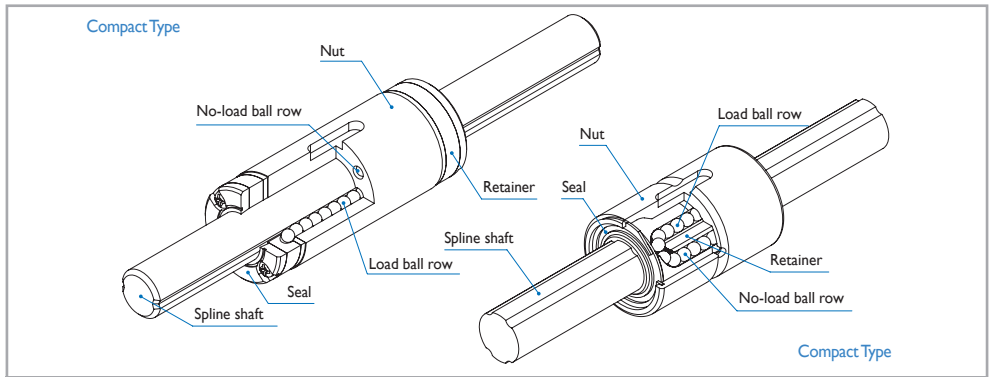

Figure 1. Structure of ball spline













Ball Spline	Compact Ball Spline	- 2 rows and 4 points contact type - Simple structure and very compact type
	Linear Ball Spline	- 4 rows and 2 points contact type - Angular contact type, and high load rating in radial direction and torque direction

## 2 Selection of Ball Spline

### I. Overview

To select a ball spline, it is necessary to identify the details of requirements, prioritize them, and then choose the one that meets the service conditions.

### 2. Procedure

- |   |  |
|---|--|
| 1 Determine service conditions                    |  The equipment to be used, maintenance structure, installation space, assembly state, functional requirements, service environments   |
| 2 Select a type                                   |  Determine an appropriate type in consideration of motion conditions, load magnitude, rigidity, friction, and assembly.   |
| 3 Select a model number                           |  Determine an appropriate model number and a quantity of nuts in consideration of the assembled space, load, etc.   |
| 4 Calculate load                                  |  Calculate the vertical, horizontal, and moment load imposed on nut and shaft, a critical speed of shaft, an operating speed of shaft, etc.   |
| 5 Calculate equivalent load                       |  Convert each load imposed on nut and shaft into equivalent load.   |
| 6 Calculate mean load                             |  Convert each load imposed on nut and shaft and the variable load at deceleration & acceleration into mean load.  |
| 7 Calculate static safety factor                  |  Calculate the static safety factor with basic load rating and maximum equivalent load, and check if the calculated value meets a service condition.   |
| 8 Calculate life                                  |  Calculate load rating and life, and check if the calculated values meet service conditions.  |
| 9 Review preload and clearance                    |  Determine the preload and clearance that meet service conditions.  |
| 10 Determine a class of precision                 |  Determine a class of precision for the travel or rotation that a ball spline needs.  |
| 11 Lubrication, dust proof, and surface treatment |  Determine a grease lubricant, oil lubricant, or a special lubricant suitable for an environment. Select a dust-proof seal/ Determine the surface treatment for dust proof and low dust generation. |
| 12 Complete selection                             |  Determine the final specifications of a ball spline.   |



### 3 Life Calculation

#### 1. Life

When a ball spline runs in the course of bearing external load, the stress, which arises when the raceway surface of nut and axis and a rolling element bear continuously repeated load, causes fatigue failure and leads to flaking. Life of a ball spline refers to a total travel distance until the point that flaking arises due to initial fatigue failure.

•A ball spline can have defects earlier than the time of normal flaking caused by its wear or fatigue in the following cases

- a. Excess load by the imprecise assembly following a difference in temperature or tolerance
- b. If a ball spline is contaminated with foreign substances
- c. Driving with insufficient lubrication
- d. Reciprocating motion in a very short distance in the form of vibration or wave during halting or driving
- e. Excessive load or rotational torque imposed on a ball spline
- f. Deformation of plastic end-plate

#### 2. Rating fatigue life L

Generally Ball Spline does not always have an equal life span even though its products are manufactured in the same way, because of the difference in scattering of original fatigue of raw material. For this reason, the reference value of life of a ball spline is defined as the rating fatigue life which is a total driving distance that 90% of ball splines in one group with the same specifications can reach without flaking at the time when all in the group run under the same conditions.

Radial load

$$L = \left( \frac{f_H \cdot f_T \cdot f_C}{f_W} \cdot \frac{C}{P_C} \right)^3 \times 50 \text{ km}$$

L : Rated life (km)

C : Basic dynamic rated load (N)

T : Basic dynamic rated torque (N□m)

P<sub>C</sub> : Calculated load (N)

P<sub>T</sub> : Calculated torque (N□m)

f<sub>H</sub> : Hardness factor (See Figure 2.)

f<sub>T</sub> : Temperature factor (See Figure 3.)

f<sub>C</sub> : Contact factor (See Table 2.)

f<sub>W</sub> : Load factor (See Table 3.)

Torque load

$$L = \left( \frac{f_H \cdot f_T \cdot f_C}{f_W} \cdot \frac{T}{P_T} \right)^3 \times 50 \text{ km}$$

L<sub>h</sub> : Life time (h)

l : Stroke length (m)

n<sub>l</sub> : No. of reciprocating motions per minute (min<sup>-1</sup>)

$$L_h = \frac{10^3 \cdot L}{2 \times l_s \times n_l \times 60}$$

• Hardness factor ( $f_H$ )

To implement the best performance of a ball spline, it is necessary to maintain appropriately the hardness and depth of the raceway surface of the nut and shaft that contact a ball as a rolling element. WON Ball Spline has HRC58-64 surface hardness. There is no need to consider hardness factor. If the hardness is lowered than a baseline, load capacity of a ball spline decreases. In this case, it is necessary to apply hardness factor to life calculation

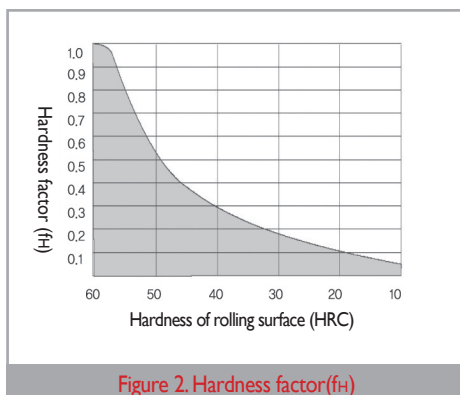

Figure 2. Hardness factor( $f_H$ )

• Temperature factor ( $f_T$ )

If high temperature over 100°C is applied to a ball spline, it is necessary to take into account the temperature factor ( $f_T$ ) shown in the figure at the time when a ball spline is selected. For use at over 80°C, please contact WON ST.

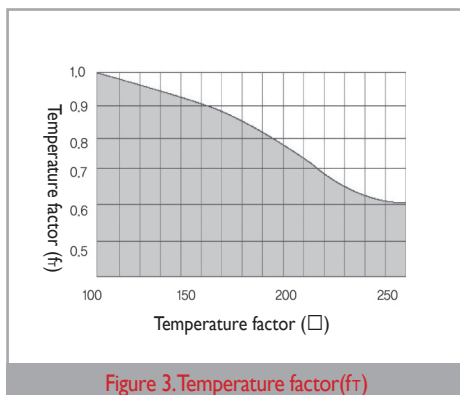

Figure 3. Temperature factor( $f_T$ )

Note) If ambient temperature is over 80°C, it is necessary to change the material of seal, end plate, and support plate to the one which meets the specifications for high temperature.

• Contact factor ( $f_c$ )

If over two blocks of a ball splines are closely assembled and mounted, uniform load may not be applied to them due to difference among mounting surfaces. Therefore, it is required to multiply basic static load rating (C) and basic dynamic load rating ( $C_0$ ) by the contact factor shown in Table 1.

Table 2. Contact factor ( $f_c$ )

No. of nuts in close contact	Contact factor $f_c$
2	0.81
3	0.72
4	0.66
5	0.61
Over 6	0.6
Common use	1.0

• Load factor (fw)

Generally the static load applied to the nut of a linear motion guide can be calculated in formula. However, while a machine is running, the load imposed on the nut tends to come from vibration or impacts. Therefore, as for the vibration or impact load at high-speed running, it is necessary to divide the basic dynamic load rating of a ball spline by the load factor (fw) shown in Table 3.

Table 3. Load facto (fw)

External condition	Service conditions	Load factor(fw)
Low	Smooth running at mild speed; no external vibration or impacts	1.0 ~ 1.3
Moderate	Moderate - Low speed; moderate external vibration or impacts	1.2 ~ 1.5
High	High - High speed; strong vibration or impacts	1.5 ~ 2.0
Very high	Very high - Very high speed; strong vibration and impacts at running	2.0 ~ 4.0

### 3. Static Safety Factor fs

If heavy load or big impact is imposed on a ball spline, its rolling element and raceway surface have local and permanent deformation that leads to lowering its running performance. Limit of a ball spline depends on its service conditions and requirements.

In this case, the static safety factor fs is calculated in the following formula, and its general values are presented in Table 4.

$$f_s = \frac{C_o}{P_{ro}} \quad \text{또는} \quad f_s = \frac{T_o}{P_{to}}$$

- fs : Static safety factor
- Co : Basic static rated load (N)
- To : Basic static rated torque (N□m)
- Pro : Calculated load (N)
- Pto : Calculated torque (N□m)

Table 4. Static safety factor (fs)

Service condition	safety factor (fs)
Vibration and impacts	3 ~ 5
High running	2 ~ 4
Normal operation	1 ~ 3

### 4. Basic Dynamic Load Rating (C)

Basic dynamic load rating is ability of a ball spline to bear load, which represents an applicable constant load in direction and magnitude when the rated fatigue life is 50km. The reference value of basic dynamic load rating of WON Ball Spline is 50km (ball type). It is used for calculating life of a ball spline while driving under constant load in magnitude from the center of a nut to bottom.

Each value of basic dynamic load rating (C) is described in the catalogue.

## 5. Basic static load rating $C_0$

If a ball spline is applied by excessive load or instantly by big impact load, partially permanent deformation occurs between a rolling element and the raceway surface. If deformation reaches to a certain extent, it hinders smooth driving.

Basic static load rating is defined as the constant static load in direction and magnitude when the total permanent deformation of the raceway surface of nut and shaft and a ball as a rolling element is 0.0001 times bigger than the diameter of the rolling element.

In a ball spline, it refers to the load in radial direction on the center of the contact of nut and ball. Each value of basic static load rating ( $C_0$ ) is described in the specification table.

## 6. Basic Dynamic Rated Torque $T$

Load rated torque refers to the constant torque in direction and size in the condition where 90% in one group of ball splines with the same specification travel 50km without material damage (flaking). See Figure 5.

## 7. Basic Static Rated Torque $T_0$ □ Basic Static Rated Moment $T_M$

Basic static torque and basic static moment refer to the static torque and moment that can face a certain amount of contact stress at the center of the contact of the rolling element with the maximum load and the raceway surface, when torque or moment load is imposed on. The  $T_M$  described in the table of dimensions is the basic static rated moment of one sleeve and of two sleeves in close contact.

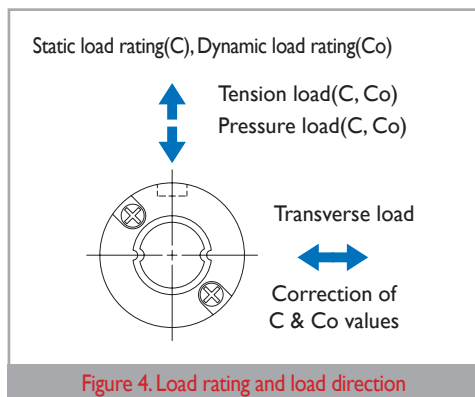

Figure 4. Load rating and load direction

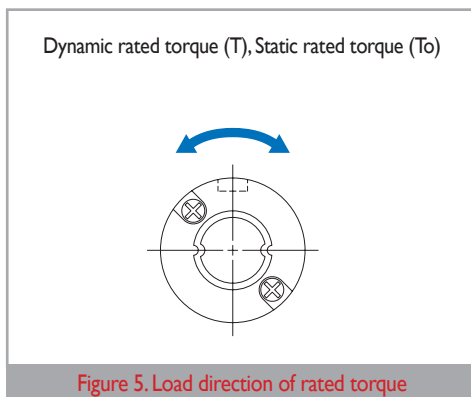

Figure 5. Load direction of rated torque

A compact-type ball spline is used after load rating is corrected in the direction of load.

The basic dynamic load rating and basic static load rating shown in the table of dimensions are corrected according to the following table.

(Basic dynamic rated torque, basic static rated torque and basic rated moment are also corrected in the same multiple.)

Size	Basic dynamic load rating			Basic static load rating		
	Pressure load	Tension load	Transverse load	Pressure load	Tension load	Transverse load
4~12	C	C	1.73 $C_0$	$C_0$	$C_0$	1.73 $C_0$
15~40	C	C	1.19 $C_0$	$C_0$	$C_0$	1.19 $C_0$

## 4 Preload of Ball Spline

### Preload

A ball spline can be preloaded differently depending on service conditions. In order to increase rigidity of a ball spline and lessen the displacement for external load, it is possible to preload the device in the way of removing a gap with the use of the ball (as a rolling element) inserted in between a shaft and a nut, or inserting a ball larger than the gap between the shaft and nut.

If vibration or variable load is imposed on and high rigidity are needed, it is necessary to determine the preload suitable for service conditions in consideration of life of a ball spline.

Table 5. Preload

External condition	Symbol	Preload (N)	Applied equipment
Zero preload	CL	$0^{(1)} \sim +$	•Mechanical equipment requiring light running with small torque
Standard	CM	$0^{(2)} \sim -$	•General mechanical equipment •Mechanical equipment requiring small motion resistance
Light preload	CT	$0.02C_0$	•Mechanical equipment requiring rigidity •Mechanical equipment to which large vibration or impact load is applied •Mechanical equipment to which big moment load or variable load is applied

Note. (1) Zero preload

(2) Zero or a little of preload

Remark: Light preload is not applied to WSP (F) (K) 4.

## 5 Precision

Precision of a ball spline is related to its outside diameter of nut runout on the basis of shaft. WON Ball Spline has the precision of KS B 1422(JIS B 1193).

The precision of ball spline is categorized into three classes: normal (no symbol), high (H), and precision (P). A class of precision is described according to the arrangement of a model number.

The values in the tables include the precision in the case where the shaft ends are processed.

For the precision class of ball spline, see tables 6, 7, and 8.

WON ST also manufactures a product that has higher precision than in the tables, or a product with a special shape at request of a customer. If necessary, please contact us.

Table 6. Torsion of ball spline

External condition	Torsion(MAX)		
	Normal	High	Precision
Tolerance	33□/100□	13□/100□	6□/100□

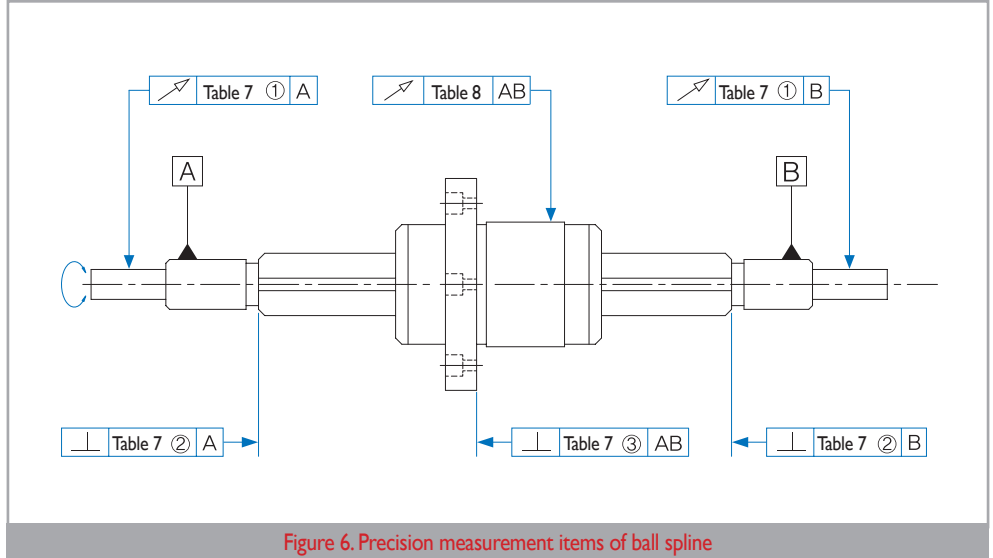

Figure 6. Precision measurement items of ball spline

Table 7. Precision of each part of ball spline

Unit :  $\mu\text{m}$

Model no.		WSP 4	WSP 5	WSP 6	WSP 8	WSP 10	WSP 12	-	WSP 15	WSP 20	WSP 25	WSP 30	WSP 40	
		-			WLS 8	WLS 10	-	WLS 13	WLS 16	WLS 20	WLS 25	WLS 30	WLS 40	
$\mu\text{m}$ Radial direction runout of installation part	Normal (No symbol)	33			41			46			53		62	
	High (H)	14			17			19			22		25	
	Precision (P)	8			10			12			13		15	
$\mu\text{m}$ Vertical angle of the cross section of spline part	Normal (No symbol)	22						27			33		39	
	High (H)	9						6			13		16	
	Precision (P)	6						8			9		11	
$\mu\text{m}$ Vertical angle of the flange side from the central line of spline shaft	Normal (No symbol)	27						33			39		46	
	High (H)	11						13			16		19	
	Precision (P)	8						9			11		13	

Table 8. Radial direction runout of the central line of ball spline shaft

 Unit :  $\mu\text{m}$ 

Length of spline shaft (mm)	Above	-	200	315	400	500	630	800	1000	1250
	Below	200	315	400	500	630	800	1000	1250	1600
WSP 4 WSP 5 WSP 6 WSP 8  WLS 8	Normal (No symbol)	72	133	185	236	-	-	-	-	-
	High (H)	46	89	128	163	-	-	-	-	-
	Precision (P)	26	57	82	108	-	-	-	-	-
WSP 10 WSP 12  WLS 10	Normal (No symbol)	59	83	103	123	151	190	-	-	-
	High (H)	36	54	68	82	102	130	-	-	-
	Precision (P)	20	32	41	51	65	85	-	-	-
WSP 15 WSP 20  WLS 13 WLS 16 WLS 20	Normal (No symbol)	56	71	83	95	112	137	170	-	-
	High (H)	34	45	53	62	75	92	115	-	-
	Precision (P)	18	25	31	38	46	58	75	-	-
WSP 25 WSP 30  WLS 25 WLS 30	Normal (No symbol)	53	58	70	78	88	103	124	151	-
	High (H)	32	39	44	50	57	68	83	102	-
	Precision (P)	18	21	25	29	34	42	52	65	-
WSP 40  WLS 40	Normal (No symbol)	53	58	63	68	74	84	97	114	139
	High (H)	32	36	39	43	47	54	63	76	93
		16	19	21	24	27	32	38	47	-



## 6 Lubrication and Dust Resistance

A ball spline has the treatment with anti-rust additives that has affinity with all mineral oils. It can be lubricated with oil or grease. Grease lubrication generates an additional sealing effect, and sticks well in a ball spline. Therefore, it is recommended to use grease.

In case of grease refilling, it is necessary to use a ball spline whose nut has an oil hole. WON Ball Spline is dust resistant through its special rubber seal. Nevertheless, if a lot of foreign substances or dust float, it is recommended to attach an anti-dust device to protect a spline shaft against relatively large impurities like cutting chips or sand.

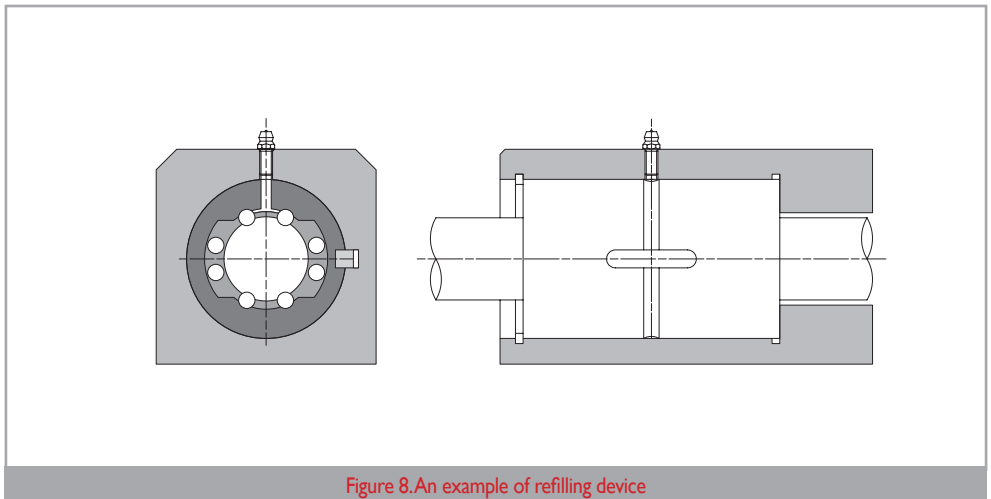
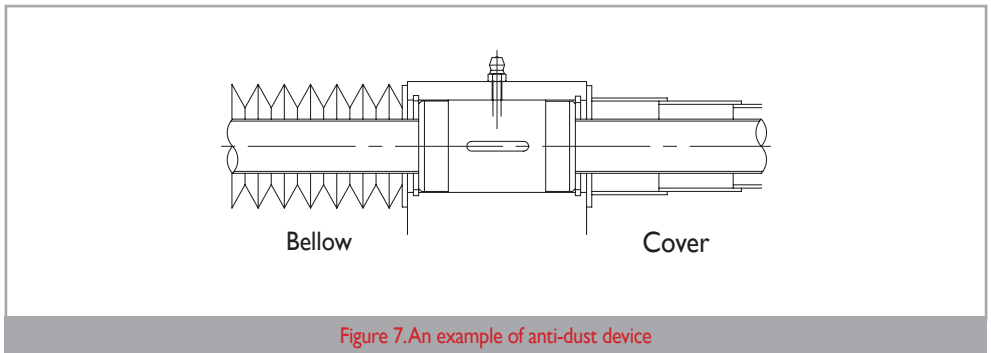

## 7 Assembly

### Nut fitting

As for nut and housing fitting, WON Ball Spline has a transition fit (J7).

If precision and rigidity are not needed much, it is possible to apply a clearance fit (H7).

### Insertion of spline nut

Inserting a spline nut into a housing may affect the operation of a device. In order to prevent any impact from being imposed on a retainer, use a jig for installation as shown in the following figure when inserting the nut.

### Insertion of spline shaft

When a spline shaft is inserted into a spline nut, a ball may come out. Therefore, set raceway groove of the shaft, ball row of the spline nut, and position of a seal rightly before insertion.

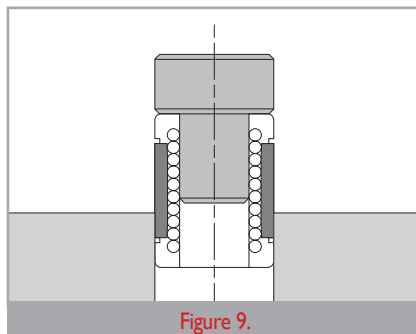

## 8 Caution for Use

The working temperature of WON Ball Spline is max. 120°C in case of discontinuous use, and max. 80°C for continuous use. If above 80°C, please contact WON ST.

WON Ball Spline is set to optimal precision in the condition where its spline shaft and nut mark are in the same direction and position (See Figure 10). To attach it to a machine, it is careful not to change steering of a spline shaft, arrangement of a nut, and a steering direction.

If more than two keys are used to fix the rotation direction of an outer sleeve on the basis of one shaft and over two nuts, it is required to make the position of each key groove of nut in parallel. For this case, please contact WON ST.

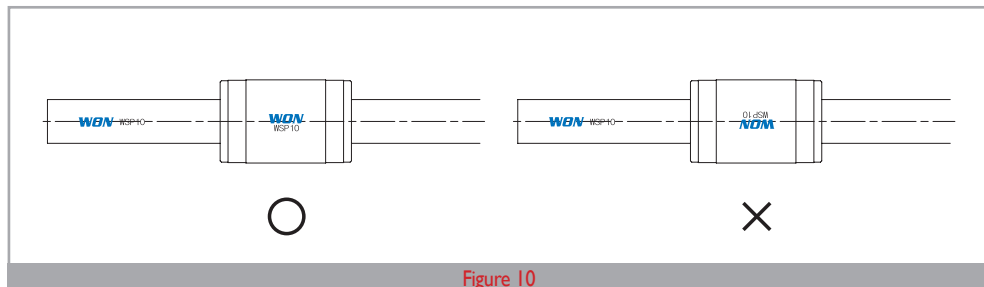

Figure 10

## 9 Compact Ball Spline

### 1. Structure and Features

WON Ball Spline is composed of a nut and a shaft. The nut has a ball as a rolling element installed in. The rolling surface of the shaft has a Gothic arch shaped groove processed. The ball of the nut rolls in a linear line along the precisely polished groove of the rolling surface.

With one nut, the device can bear radial load and moment load and can transmit rotational torque in the circumferential direction of the shaft. With the use of the ball in between the raceways of nut and shaft, it is possible to apply preload. For this reason, the ball spline is strongly resistant for vibration or impact load. The linear motion system is applicable to an environment that needs high positioning precision, high-speed motion, and a long life span.

### 2. Transmission of high torque

A ball spline have Gothic arch shaped grooves in two rows on the rolling surface of nut and the rolling surface of shaft, which are precisely polished. Therefore, a ball can contact four points. Thanks to such a structure, it is possible to let the two rows evenly bear the rotational torque of nut and transmit rotational force.

### 3. High load capacity and long life

A ball spline has a linear type and has the structure of contact between the rolling surface of nut and shaft, and a ball as a rolling element. In the condition diameter of a shaft is equal, the device is capable of bearing rated load about ten times more than a ball bushing, ensuring a long life span. Therefore, it supports a compact design of equipment and bears moment load and overhang load as well as radial load.

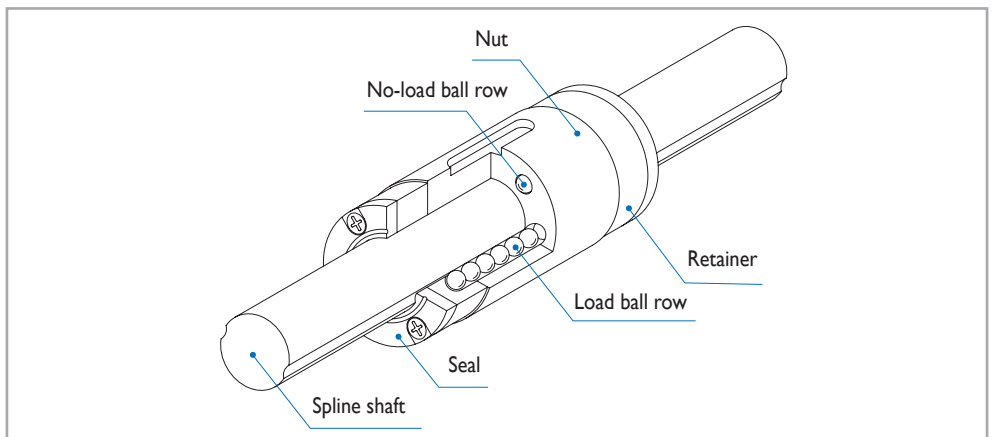
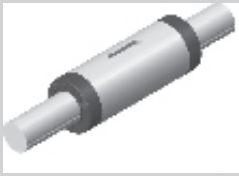
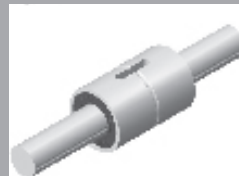
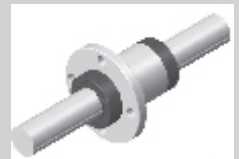
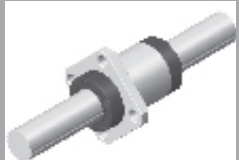

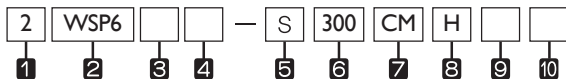

Figure 11. Structure of compact ball spline

Classification	Type	Shape and Features	
Cylinder Type	WSP WSPL		It has a general spline nut that has a key groove helping to fix the position of a rotational direction accurately.
	WSP WSPL		Since a retainer is placed inside, this ball spline has good appearance and rigidity.
	WSPF WSPFL		As a round flange type, it can be installed easily.
	WSPK WSPKL		As a square flange type, it can be installed easily.
Flange Type	WSPTF WSPTFO		As a round flange type, it can be installed easily.

## WSP Series

An example of the Composition of Model Name & Number



- 1** Number of nuts assembled in one shaft
- 2** Model No.
- 3** Material of nut: **No symbol**-Standard material/**M**-Stainless
- 4** **No symbol**-Standard nut / **E**-Special nut specification
- 5** Type of shaft: **S**-Solid / **H**-Hollow
- 6** Length of shaft
- 7** Symbol of clearance : **CL**-No preload / **CM**-Standard / **CT**-Light preload
- 8** Symbol of precision : **No symbol**-Normal / **H**-Precision / **P**-Super
- 9** Material of shaft : **No symbol**-Standard material / **M**-Stainless
- 10** **No symbol**-Standard shaft / **E**-Special shaft specification

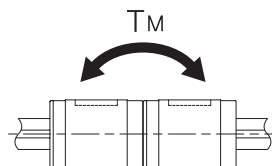

Model No.	Major dimensions											
	Outside diameter		L <sub>1</sub>	L <sub>2</sub>	Dimension of key groove				Main		Length L	Max. length
	D	Tolerance			W	Tolerance	t	l	d	Tolerance		
WSP 4 <sup>(2)</sup>	8	0 -0.009	12	79	-	+0.014 0	1	-	4	0 -0.012	100 150	200
WSP 5	10	0 -0.009	17.5	89	2	+0.014 0	1.2	6	5	0 -0.012	100 150	200
WSP 6	12	0 -0.011	20.6	12	2	+0.014 0	1.2	8	6	0 -0.012	150 200	300
WSP 8	15	0 -0.011	24.4	14	2.5	+0.014 0	1.5	8.5	8	0 -0.015	150 200 250	500
WSP 10	19	0 -0.013	29.6	17.8	3	+0.014 0	1.8	11	10	0 -0.015	200 300	600
WSP 12	21	0 -0.013	34.7	22.7	3	+0.014 0	1.8	15	12	0 -0.018	200 300 400	800
WSP 15	23	0 -0.013	40	27	3.5	+0.018 0	2	20	13.6	0 -0.018	200 300 400	1000
WSP 20	30	0 -0.016	50	33	4	+0.018 0	2.5	26	18.2	0 -0.021	300 400 500 600	1000
WSP 25	37	0 -0.016	60	39.2	5	+0.018 0	3	29	22.6	0 -0.021	300 400 500 600 800	1200
WSP 30	45	0 -0.016	70	43	7	+0.022 0	4	35	27.2	0 -0.021	400 500 600 700 1100	1200
WSP 40	60	0 -0.019	100	70.8	10	+0.022 0	4.5	55	37.2	0 -0.025	400 500 600 700 1100	1200

Note (1) The top value of the static rated moment  $T_M$  means the value of one nut, and the bottom value represents the value of two nuts in contact.

(2) WSP4 has no seal.

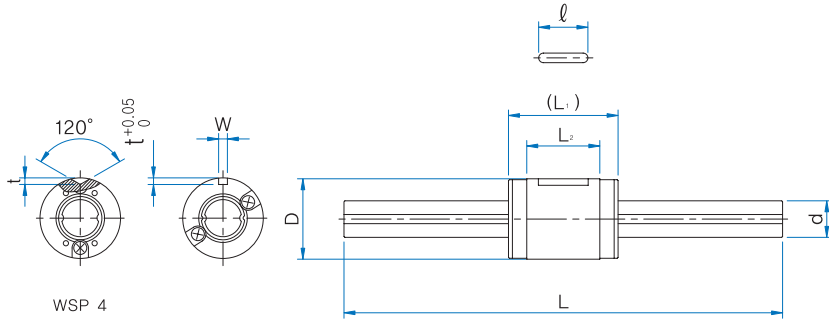

Unit : mm

Basic dynamic load rating <b>C</b> N	Basic static load rating <b>Co</b> N	Basic dynamic rated torque <b>T</b> N·m	Basic static rated torque <b>To</b> N·m	Basic static rated moment <sup>(1)</sup> <b>Tm</b> N·m	Spline nut		Model No.
					Spline nut g	Spline shaft g/100mm	
304	382	0.686	0.882	0.49 2.94	2.5	9.6	WSP 4
588	637	1.764	1.96	1.078 7.84	4.8	14.9	WSP 5
715	853	2.45	3.038	1.764 11.76	8.9	19	WSP 6
1176	1372	5.488	6.174	3.234 21.56	15.9	39	WSP 8
1862	2156	10.78	12.74	6.958 41.16	31.5	60.5	WSP 10
2156	2646	14.7	18.62	10.78 58.80	44	87.5	WSP 12
4241	6076	31.36	45.08	27.44 151.90	59.5	111	WSP 15
6566	9016	65.66	90.6	49.00 287.14	130	202	WSP 20
11196	14294	138.94	177.93	92.76 550.78	220	310	WSP 25
15394	19392	230.91	291.88	146.94 873.65	430	450	WSP 30
21291	31587	425.83	631.75	363.85 1939.22	760	808	WSP 40

IN0.102kgf

## WSPL Series

An example of the Composition of Model Name & Number

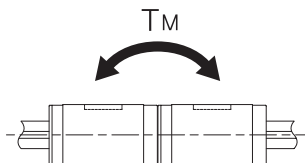
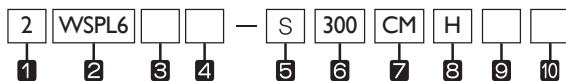

- 1 Number of nuts assembled in one shaft
- 2 Model No.
- 3 Material of nut: **No symbol**-Standard material / **M**-Stainless
- 4 **No symbol**-Standard nut / **E**-Special nut specification
- 5 Type of shaft: **S**-Solid / **H**-Hollow
- 6 Length of shaft
- 7 Symbol of clearance : **CL**-No preload / **CM**-Standard / **CT**-Light preload
- 8 Symbol of precision : **No symbol**-Normal / **H**-Precision / **P**-Super
- 9 Material of shaft : **No symbol**-Standard material / **M**-Stainless
- 10 **No symbol**-Standard shaft / **E**-Special shaft specification

Model No.	Major dimensions											
	Outside diameter		L <sub>1</sub>	L <sub>2</sub>	Dimension of key groove				Main		Length L	Max. length
	D	Tolerance			W	Tolerance	t	l	d	Tolerance		
WSPL 5	10	0 -0.009	26	17.4	2	+0.014 0	1.2	6	5	0 -0.012	100 150	200
WSPL 6	12	0 -0.011	29.8	21.2	2	+0.014 0	1.2	8	6	0 -0.012	150 200	300
WSPL 8	15	0 -0.011	36.7	26.3	2.5	+0.014 0	1.5	8.5	8	0 -0.012	150 200 250	500
WSPL 10	19	0 -0.013	47	34.9	3	+0.014 0	1.8	11	10	0 -0.015	200 300	600
WSPL 12	21	0 -0.013	53.1	41.1	3	+0.014 0	1.8	15	12	0 -0.015	200 300 400	800
WSPL 15	23	0 -0.013	65	52	3.5	+0.018 0	2	20	13.6	0 -0.018	200 300 400	1000
WSPL 20	30	0 -0.016	71	54	4	+0.018 0	2.5	26	18.2	0 -0.018	300 400 500 600	1000
WSPL 25	37	0 -0.016	84	63.2	5	+0.018 0	3	29	22.6	0 -0.021	300 400 500 600 800	1200
WSPL 30	45	0 -0.016	98	71	7	+0.022 0	4	35	27.2	0 -0.021	400 500 600 700 1100	1200

Note (1) The top value of the static rated moment  $T_M$  means the value of one nut, and the bottom value represents the value of two nuts in contact.

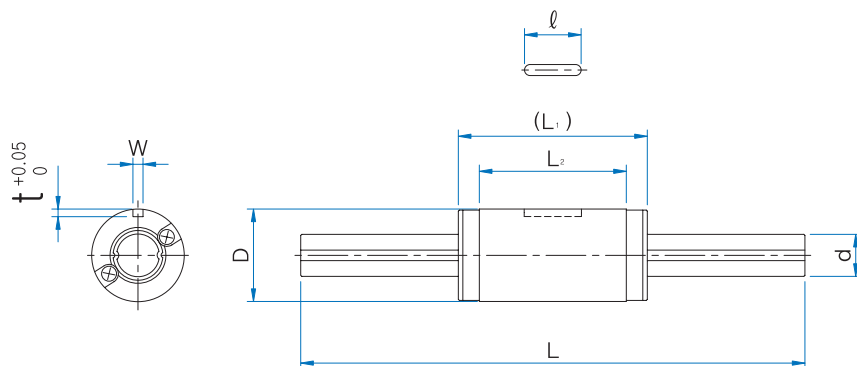

Unit : mm

Basic dynamic load rating <b>C</b> N	Basic static load rating <b>C<sub>0</sub></b> N	Basic dynamic rated torque <b>T</b> N·m	Basic static rated torque <b>T<sub>0</sub></b> N·m	Basic static rated moment <sup>(1)</sup> <b>T<sub>M</sub></b> N·m	Spline nut		Model No.
					Spline nut g	Spline shaft g/100mm	
882	1176	2.646	3.528	3.136	7.9	14.9	WSPL 5
				19.60			
1078	1470	3.626	5.194	4.998	14.5	19	WSPL 6
				27.44			
1764	2450	8.33	11.76	9.80	26.5	39	WSPL 8
				56.84			
2842	4018	16.66	23.52	22.54	56.5	60.5	WSPL 10
				115.64			
3234	4802	21.56	33.32	32.34	76.8	87.5	WSPL 12
				156.80			
6370	11564	48.02	86.24	94.08	110	111	WSPL 15
				447.86			
9310	15092	93.10	150.92	127.40	198	202	WSPL 20
				619.36			
15394	23191	192.92	289.88	228.91	336	310	WSPL 25
				1189.52			
21291	31587	319.87	473.81	363.85	634	450	WSPL 30
				1899.24			

IN 0.102kgf



## WSPT Series

An example of the Composition of Model Name & Number

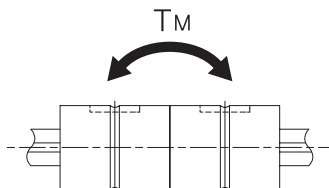
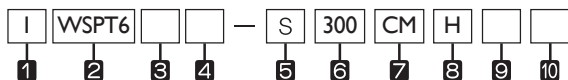

- 1 Number of nuts assembled in one shaft
- 2 Model No.
- 3 Material of nut: **No symbol**-Standard material / **M**-Stainless
- 4 **No symbol**-Standard nut / **E**-Special nut specification
- 5 Type of shaft: **S**-Solid / **H**-Hollow
- 6 Length of shaft
- 7 Symbol of clearance : **CL**-No preload / **CM**-Standard / **CT**-Light preload
- 8 Symbol of precision : **No symbol**-Normal / **H**-Precision / **P**-Super
- 9 Material of shaft : **No symbol**-Standard material / **M**-Stainless
- 10 **No symbol**-Standard shaft / **E**-Special shaft specification

Model No.	Major dimensions										
	Outside diameter		L1	Dimension of key groove				Main		Length L	Max. length
	D	Tolerance		W	Tolerance	t	l	d	Tolerance		
WSPT 4	10	0 -0.009	16	2	+0.014 0	1.2	6	4	0 -0.012	100 150	200
WSPT 5	12	0 -0.011	20	2.5	+0.014 0	1.2	8	5	0 -0.012	100 150	200
WSPT 6	14	0 -0.011	25	2.5	+0.014 0	1.2	10.5	6	0 -0.012	150 200	300
WSPT 8	16	0 -0.011	25	2.5	+0.014 0	1.2	10.5	8	0 -0.015	150 200 250	500
WSPT 10	21	0 -0.013	33	3	+0.014 0	1.5	13	10	0 -0.015	200 300	600
WSPT 12	24	0 -0.013	36	3	+0.014 0	1.5	15	12	0 -0.018	200 300 400	800
WSPT 15	31	0 -0.013	50	3.5	+0.018 0	2	17.5	13.6	0 -0.018	200 300 400	1000
WSPT 20	35	0 -0.016	63	4	+0.018 0	2.5	29	18.2	0 -0.021	300 400 500 600	1000

Note (1) The top value of the static rated moment  $T_M$  means the value of one nut, and the bottom value represents the value of two nuts in contact.

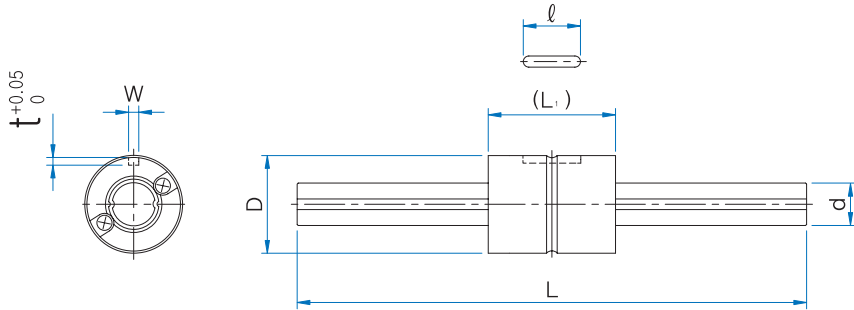

Unit : mm

Basic dynamic load rating	Basic static load rating	Basic dynamic rated torque	Basic static rated torque	Basic static rated moment <sup>(1)</sup>	Spline nut		Model No.
					Spline nut g	Spline shaft g/100mm	
C N	C <sub>0</sub> N	T N·m	T <sub>0</sub> N·m	T <sub>M</sub> N·m			
441	637	0.588	0.784	0.882 6.272	2.5	9.6	WSPT 4 <sup>(2)</sup>
686	882	0.882	1.372	1.47 11.368	4.8	14.9	WSPT 5
1176	2156	0.98	1.96	4.9 35.57	8.9	19	WSPT 6
1470	2548	1.96	2.94	5.88 43.12	15.9	39	WSPT 8
2842	4900	3.92	7.84	15.68 96.04	31.5	60.5	WSPT 10
3528	5782	5.88	10.78	19.20 135.24	44	87.5	WSPT 12
7056	12642	31.36	34.30	66.84 385.14	59.5	111	WSPT 30
10192	17836	56.84	55.86	115.64 686.0	130	202	WSPT 40

IN 0.102kgf

## WSPTF Series

An example of the Composition of Model Name & Number

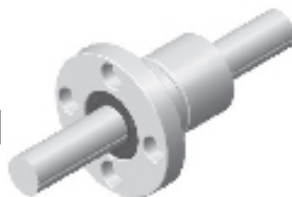
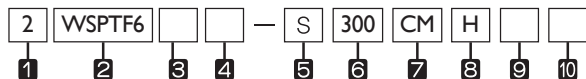

- 1 Number of nuts assembled in one shaft
- 2 Model No.
- 3 Material of nut: **No symbol**-Standard material/**M**-Stainless
- 4 **No symbol**-Standard nut / **E**-Special nut specification
- 5 Type of shaft: **S**-Solid / **H**-Hollow
- 6 Length of shaft
- 7 Symbol of clearance : **CL**-No preload / **CM**-Standard / **CT**-Light preload
- 8 Symbol of precision : **No symbol**-Normal / **H**-Precision / **P**-Super
- 9 Material of shaft : **No symbol**-Standard material / **M**-Stainless
- 10 **No symbol**-Standard shaft / **E**-Special shaft specification

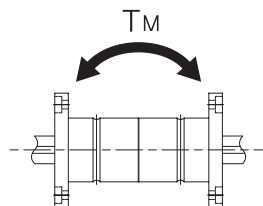

Model No.	Major dimensions										
	Outside diameter		L <sub>1</sub>	D <sub>1</sub>	T	pcd	X x Y x Z	Axial diameter		Length L	Max. length
	D	Tolerance						d	Tolerance		
WSPTF 6	14	0 -0.011	25	30	5	22	3.4 x 6.5 x 3.3	6	0 -0.012	150 200	300
WSPTF 8	16	0	25	32	5	24	3.4 x 6.5 x 3.3	8		150 200 250	500
WSPTF 10	21	-0.013	33	42	6	32	4.5 x 8 x 4.4	10	0 -0.015	200 300	600
WSPTF 12	24	0 -0.016	36	44	7	33	4.5 x 8 x 4.4	12		200 300 400	800
WSPTF 15	31		50	51	7	40	4.5 x 8 x 4.4	13.6		200 300 400	1000
WSPTF 20	35		63	58	9	45	5.5 x 9.5 x 5.4	18.2	0 -0.018	300 400 500 600	1000

Note (1) The top value of the static rated moment  $T_M$  means the value of one nut, and the bottom value represents the value of two nuts in contact.

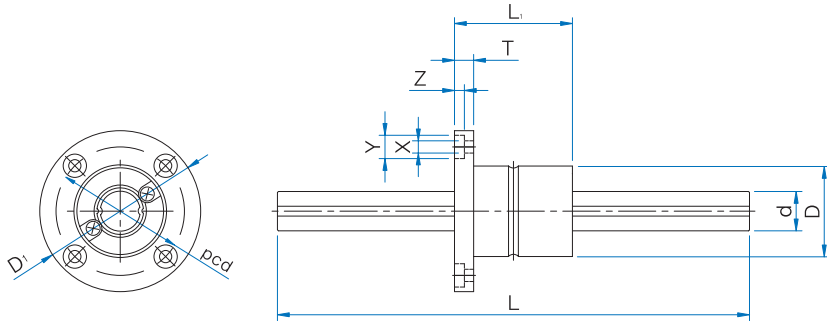

Unit : mm

Basic dynamic load rating	Basic static load rating	Basic dynamic rated torque	Basic static rated torque	Basic static rated moment <sup>(1)</sup>	Spline nut		Model No.
					Spline nut g	Spline shaft g/100mm	
C N	Co N	T N·m	To N·m	Tm N·m			
1176	2156	0.98	1.96	4.9	37.2	19	WSPTF 6
				35.57			
1470	2548	1.96	2.94	5.88	39.5	39	WSPTF 8
				43.12			
2842	4900	3.92	7.84	15.68	64.2	60.5	WSPTF 10
				96.04			
3528	5782	5.88	10.78	19.20	124.7	87.5	WSPTF 12
				135.24			
7056	12642	31.36	34.30	66.64	265.7	111	WSPTF 15
				385.14			
10192	17836	56.84	55.86	115.64	392.5	202	WSPTF 20
				686			

IN 0.102kgf

## WSPF Series

An example of the Composition of Model Name & Number

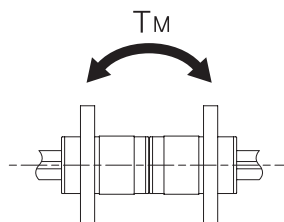
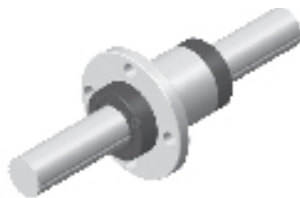
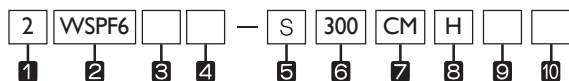

- 1 Number of nuts assembled in one shaft
- 2 Model No.
- 3 Material of nut: **No symbol**-Standard material / **M**-Stainless
- 4 **No symbol**-Standard nut / **E**-Special nut specification
- 5 Type of shaft: **S**-Solid / **H**-Hollow
- 6 Length of shaft
- 7 Symbol of clearance : **CL**-No preload / **CM**-Standard / **CT**-Light preload
- 8 Symbol of precision : **No symbol**-Normal / **H**-Precision / **P**-Super
- 9 Material of shaft : **No symbol**-Standard material / **M**-Stainless
- 10 **No symbol**-Standard shaft / **E**-Special shaft specification

Model No.	Major dimensions												
	Outside diameter		L <sub>1</sub>	L <sub>2</sub>	D <sub>1</sub>	E	T	pcd	d <sub>i</sub>	Axial diameter		Length L	Max. length
	D	Tolerance								d	Tolerance		
WSPF 5	10	0 -0.009	17.5	8.9	23	7	2.7	17	3.4	5	0	100 150	200
WSPF 6	12	0 -0.011	20.6	12	25	7	2.7	19	3.4	6	-0.012	150 200	300
WSPF 8	15		24.4	14	28	9	3.8	22	3.4	8	0	150 200 250	500
WSPF 10	19	0 -0.013	29.6	17.8	36	10	4.1	28	4.5	10	-0.015	200 300	600
WSPF 12	21		34.7	22.7	38	10	4	30	4.5	12	0	200 300 400	800
WSPF 15	23	0 -0.018	40	27	40	11	4.5	32	4.5	13.6	-0.018	200 300 400	1000
WSPF 20	30		50	33	46	14	5.5	38	4.5	18.2	0	300 400 500 600	1000
WSPF 25	37	0 -0.016	60	39.2	57	17	6.6	47	5.5	22.6	0	300 400 500 600 800	1200
WSPF 30	45		70	43	65	21	7.5	54	6.6	27.2	-0.021	400 500 600 700 1100	
WSPF 40	60	0 -0.019	100	70.8	93	26.6	12	73	9	37.2	0	700 1100	

Note (1) The top value of the static rated moment  $T_M$  means the value of one nut, and the bottom value represents the value of two nuts in contact.

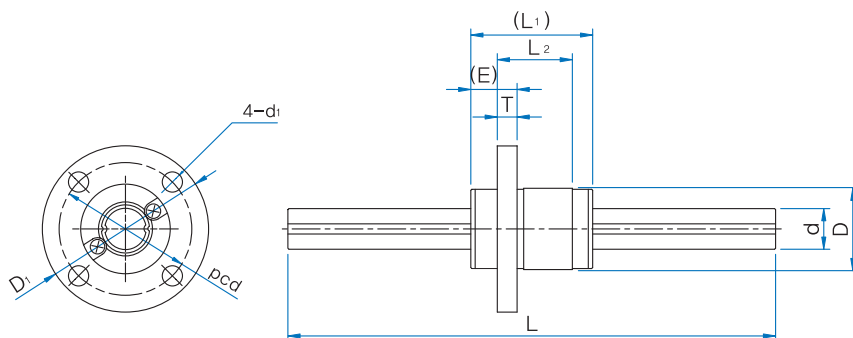

Unit : mm

Basic dynamic load rating	Basic static load rating	Basic dynamic rated torque	Basic static rated torque	Basic static rated moment <sup>(1)</sup>	Spline nut		Model No.
					Spline nut g	Spline shaft g/100mm	
C N	Co N	T N·m	To N·m	Tm N·m			
588	637	1.764	1.96	1.078	8.9	14.9	WSPF 5
				7.84			
715.4	853	2.45	3.038	1.764	13.9	19	WSPF 6
				11.76			
1176	1372	5.488	6.174	3.234	23.5	39	WSPF 8
				21.56			
1862	2156	10.78	12.74	6.958	45	60.5	WSPF 10
				41.16			
2156	2646	14.70	18.62	10.78	59	87.5	WSPF 12
				58.80			
4214	6076	31.36	45.08	27.44	77	111	WSPF 15
				151.90			
6566	9016	65.66	90.16	49.00	150	202	WSPF 20
				287.14			
11196	14294	138.94	177.93	92.76	255	310	WSPF 25
				550.78			
15349	19392	230.91	291.88	146.94	476	450	WSPF 30
				873.65			
21291	31587	425.83	631.75	363.85	962	808	WSPF 40
				1939.22			

IN 0.102kgf

## WSPFL Series

An example of the Composition of Model Name & Number

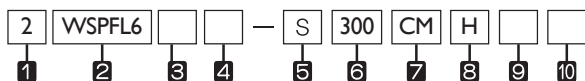

- 1 Number of nuts assembled in one shaft
- 2 Model No.
- 3 Material of nut: **No symbol**-Standard material/**M**-Stainless
- 4 **No symbol**-Standard nut / **E**-Special nut specification
- 5 Type of shaft: **S**-Solid / **H**-Hollow
- 6 Length of shaft
- 7 Symbol of clearance : **CL**-No preload / **CM**-Standard / **CT**-Light preload
- 8 Symbol of precision : **No symbol**-Normal / **H**-Precision / **P**-Super
- 9 Material of shaft : **No symbol**-Standard material / **M**-Stainless
- 10 **No symbol**-Standard shaft / **E**-Special shaft specification

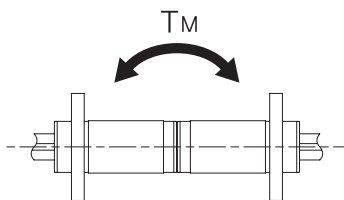
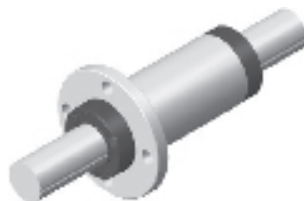

Model No.	Major dimensions												
	Outside diameter		L <sub>1</sub>	L <sub>2</sub>	D <sub>1</sub>	E	T	pcd	d <sub>i</sub>	Axial diameter		Length L	Max. length
	D	Tolerance								d	Tolerance		
WSPFL 5	10	0 -0.009	26	17.4	23	7	2.7	17	3.4	5	0	100 150	200
WSPFL 6	12	0 -0.011	29.8	21.2	25	7	2.7	19	3.4	6	-0.012	150 200	300
WSPFL 8	15	0 -0.015	36.7	26.3	28	9	3.8	22	3.4	8	0	150 200 250	500
WSPFL 10	19	0 -0.013	47	34.9	36	10	4.1	28	4.5	10	-0.015	150 200 250	600
WSPFL 12	21	0 -0.018	53.1	41.1	38	10	4	30	4.5	12	0	200 300	800
WSPFL 15	23	0 -0.016	65	52	40	11	4.5	32	4.5	13.6	-0.018	200 300 400	1000
WSPFL 20	30	0 -0.021	71	54	46	14	5.5	38	4.5	18.2	0	300 400 500 600	1000
WSPFL 25	37	0 -0.016	84	63.2	57	17	6.5	47	5.5	22.6	0	300 400 500 600 800	1200
WSPFL 30	45	0 -0.016	98	71	65	21	7.5	54	6.5	27.2	-0.021	400 500 600 700 1100	

Note (1) The top value of the static rated moment  $T_M$  means the value of one nut, and the bottom value represents the value of two nuts in contact.

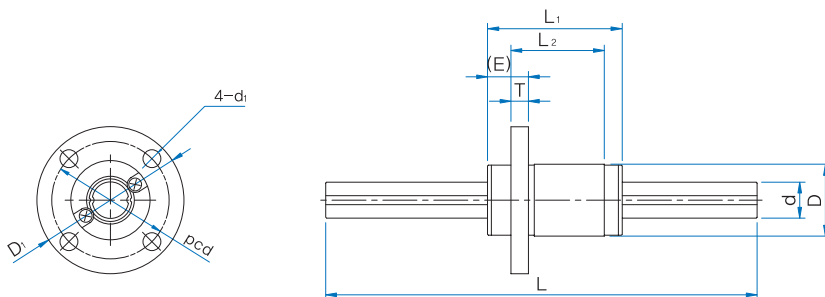

Unit : mm

Basic dynamic load rating	Basic static load rating	Basic dynamic rated torque	Basic static rated torque	Basic static rated moment <sup>(1)</sup>	Spline nut		Model No.
					Spline nut g	Spline shaft g/100mm	
C N	Co N	T N·m	To N·m	Tm N·m			
882	1176	2.646	3.528	3.136	12	14.9	WSPFL 5
				19.60			
1078	1470	3.626	5.194	4.998	19.5	19	WSPFL 6
				27.44			
1764	2450	8.33	11.76	9.80	34.1	39	WSPFL 8
				56.84			
2842	4018	16.66	23.52	22.54	70	60.5	WSPFL 10
				115.64			
3234	4802	21.56	33.32	32.34	91.8	87.5	WSPFL 12
				156.80			
6370	11564	48.02	86.24	94.08	127.5	111	WSPFL 15
				447.86			
9310	15092	93.10	150.92	127.40	218	202	WSPFL 20
				619.36			
15394	23191	192.92	289.88	228.91	371	310	WSPFL 25
				1189.52			
21291	31587	319.84	473.81	363.85	680	450	WSPFL 30
				1899.24			

IN 0.102kgf



## WSPK Series

An example of the Composition of Model Name & Number

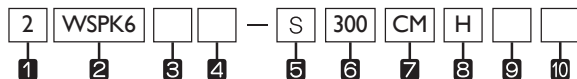

- 1 Number of nuts assembled in one shaft
- 2 Model No.
- 3 Material of nut: **No symbol**-Standard material/**M**-Stainless
- 4 **No symbol**-Standard nut / **E**-Special nut specification
- 5 Type of shaft: **S**-Solid / **H**-Hollow
- 6 Length of shaft
- 7 Symbol of clearance : **CL**-No preload / **CM**-Standard / **CT**-Light preload
- 8 Symbol of precision : **No symbol**-Normal / **H**-Precision / **P**-Super
- 9 Material of shaft : **No symbol**-Standard material / **M**-Stainless
- 10 **No symbol**-Standard shaft / **E**-Special shaft specification

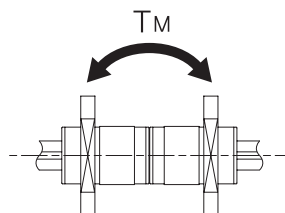
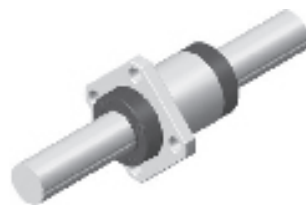

Model No.	Major dimensions													Length L	Max. length	
	Outside diameter		L <sub>1</sub>	L <sub>2</sub>	D <sub>1</sub>	B	E	T	pcd	d <sub>1</sub>	Axial diameter		Length L			Max. length
	D	Tolerance									d	Tolerance				
WSPK 4 <sup>(2)</sup>	8	0	12	7.9	21	10	4.6	2.5	15	3.4	4	0 -0.012	100 150	200		
WSPK 5	10	-0.009	17.5	8.9	23	18	7	2.7	17	3.4	5		100 150	200		
WSPK 6	12	0	20.6	12	25	20	7	2.7	19	3.4	6	0 -0.015	150 200	300		
WSPK 8	15	-0.011	24.4	14	28	22	9	3.8	22	3.4	8		150 200 250	500		
WSPK 10	19	0 -0.013	29.6	17.8	36	28	10	4.1	28	4.5	10	0 -0.018	200 300	600		
WSPK 12	21		34.7	22.7	38	30	10	4	30	4.5	12		200 300 400	800		
WSPK 15	23	0 -0.016	40	27	40	31	11	4.5	32	4.5	13.6	0 -0.021	200 300 400	1000		
WSPK 20	30		50	33	46	35	14	5.5	38	4.5	18.2		300 400 500 600	1000		
WSPK 25	37	0 -0.019	60	39.2	57	43	17	6.6	47	5.5	22.6	0 -0.025	300 400 500 600 800	1200		
WSPK 30	45		70	43	65	50	21	7.5	54	6.6	27.2		400 500 600 700 1100			
WSPK 40	60	0 -0.019	100	70.8	93	73	26.6	12	73	9	37.2	0 -0.025				

Note (1) The top value of the static rated moment  $T_M$  means the value of one nut, and the bottom value represents the value of two nuts in contact.

(2) WSPK4 has no seal.

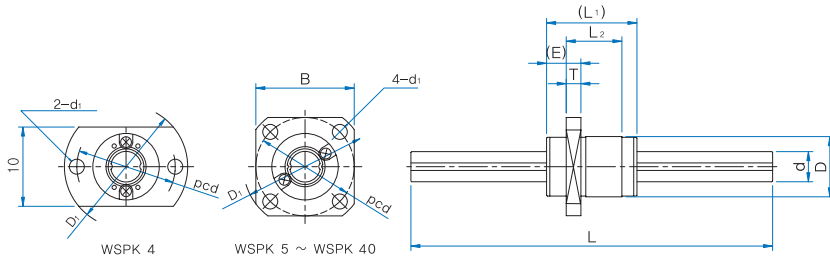

Unit : mm

Basic dynamic load rating	Basic static load rating	Basic dynamic rated torque	Basic static rated torque	Basic static rated moment <sup>(1)</sup>	Spline nut		Model No.
					Spline nut g	Spline shaft g/100mm	
C N	Co N	T N·m	To N·m	Tm N·m			
303	382	0.686	0.882	0.49	5.1	9.6	WSPK 4 <sup>(2)</sup>
				2.94			
588	637	1.764	1.96	1.078	8.9	14.9	WSPK 5
				7.84			
715.4	852.6	2.45	3.038	1.764	13.9	19	WSPK 6
				11.76			
1176	1372	5.488	6.174	3.234	23.5	39	WSPK 8
				21.56			
1862	2156	10.78	12.74	6.958	45	60.5	WSPK 10
				41.16			
2156	2646	14.70	18.62	10.78	59	87.5	WSPK 12
				58.80			
4214	6076	31.36	45.08	27.44	77	111	WSPK 15
				151.90			
6566	9016	65.66	90.16	49.00	150	202	WSPK 20
				287.14			
11196	14294	138.94	177.93	92.76	255	310	WSPK 25
				550.78			
15394	19392	230.91	291.88	146.94	476	450	WSPK 30
				873.65			
21291	31587	425.83	631.75	363.85	962	808	WSPK 40
				1939.22			

IN0.102kgf

## WSPKL Series

An example of the Composition of Model Name & Number

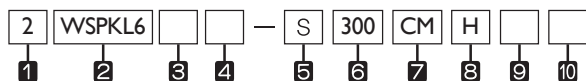

- 1 Number of nuts assembled in one shaft
- 2 Model No.
- 3 Material of nut: **No symbol**-Standard material/**M**-Stainless
- 4 **No symbol**-Standard nut / **E**-Special nut specification
- 5 Type of shaft: **S**-Solid / **H**-Hollow
- 6 Length of shaft
- 7 Symbol of clearance : **CL**-No preload / **CM**-Standard / **CT**-Light preload
- 8 Symbol of precision : **No symbol**-Normal / **H**-Precision / **P**-Super
- 9 Material of shaft : **No symbol**-Standard material / **M**-Stainless
- 10 **No symbol**-Standard shaft / **E**-Special shaft specification

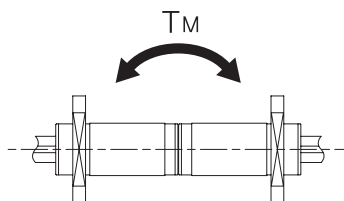
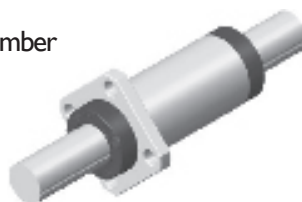

Model No.	Major dimensions													Length L	Max. length	
	Outside diameter		L <sub>1</sub>	L <sub>2</sub>	D <sub>1</sub>	E	B	T	pcd	d <sub>i</sub>	Axial diameter		Length L			Max. length
	D	Tolerance									d	Tolerance				
WSPKL 5	10	0 -0.009	26	17.4	23	7	18	2.7	17	3.4	5	0	100 150	200		
WSPKL 6	12	0 -0.011	29.8	21.2	25	7	20	2.7	19	3.4	6	-0.012	150 200	300		
WSPKL 8	15	0 -0.015	36.7	26.3	28	9	22	3.8	22	3.4	8	0	150 200 250	500		
WSPKL 10	19	0 -0.013	47	34.9	36	10	28	4.1	28	4.5	10	-0.015	200 300	600		
WSPKL 12	21	0 -0.013	53.1	41.1	38	10	30	4	30	4.5	12	0	200 300 400	800		
WSPKL 15	23	0 -0.018	65	52	40	11	31	4.5	32	4.5	13.6	-0.018	200 300 400	1000		
WSPKL 20	30	0 -0.016	71	54	46	14	35	5.5	38	4.5	18.2	0	300 400 500 600	1000		
WSPKL 25	37	0 -0.021	84	63.2	57	17	43	6.6	47	5.5	22.6	-0.021	300 400 500 600 800	1200		
WSPKL 30	45	0 -0.021	98	71	65	21	50	7.5	54	6.6	27.2	-0.021	400 500 600 700 1100			

Note (1) The top value of the static rated moment  $T_M$  means the value of one nut, and the bottom value represents the value of two nuts in contact.

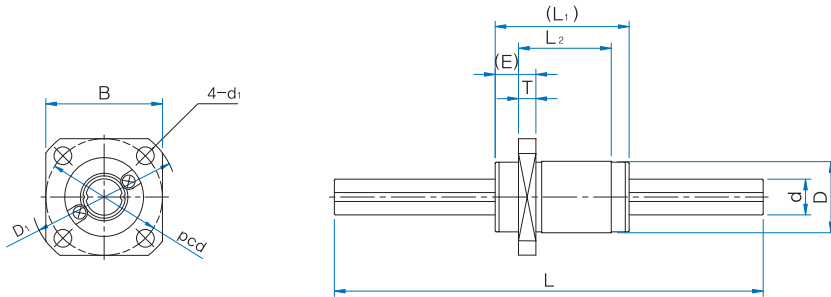

Unit : mm

Basic dynamic load rating	Basic static load rating	Basic dynamic rated torque	Basic static rated torque	Basic static rated moment <sup>(1)</sup>	Spline nut		Model No.
					Spline nut g	Spline shaft g/100mm	
C N	C <sub>0</sub> N	T N·m	T <sub>0</sub> N·m	T <sub>M</sub> N·m			
882	1176	2.646	3.528	3.136	12	14.9	WSPKL 5
				19.60			
1078	1470	3.626	5.194	4.998	19.5	19	WSPKL 6
				27.44			
1764	2450	8.33	11.76	9.80	34.1	39	WSPKL 8
				56.84			
2842	4010	16.66	23.52	22.54	70	60.5	WSPKL 10
				115.64			
3234	4802	21.56	33.32	32.34	91.8	87.5	WSPKL 12
				156.80			
6370	11564	48.02	86.24	94.08	127.5	111	WSPKL 15
				447.86			
9310	15092	93.10	150.92	127.40	218	202	WSPKL 20
				619.36			
15394	23191	192.92	289.88	228.91	371	310	WSPKL 25
				1189.52			
21291	31587	319.87	473.81	363.85	680	450	WSPKL 30
				1899.24			

IN 0.102kgf

## WSPTO Series

An example of the Composition of Model Name & Number

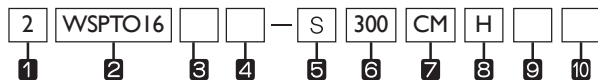

- 1 Number of nuts assembled in one shaft
- 2 Model No.
- 3 Material of nut: **No symbol**-Standard material / **M**-Stainless
- 4 **No symbol**-Standard nut / **E**-Special nut specification
- 5 Type of shaft: **S**-Solid / **H**-Hollow
- 6 Length of shaft
- 7 Symbol of clearance : **CL**-No preload / **CM**-Standard / **CT**-Light preload
- 8 Symbol of precision : **No symbol**-Normal / **H**-Precision / **P**-Super
- 9 Material of shaft : **No symbol**-Standard material / **M**-Stainless
- 10 **No symbol**-Standard shaft / **E**-Special shaft specification

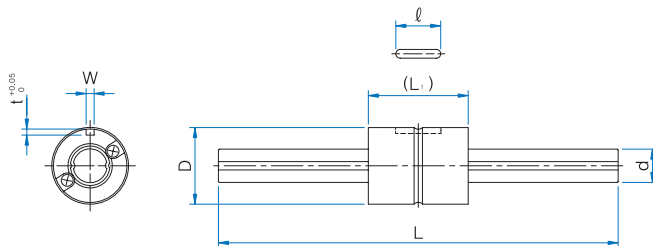
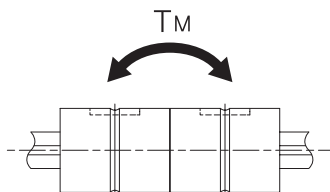

□ □ : mm

Model No.	Major dimensions										
	Outside diameter		L <sub>i</sub>	Dimension of key groove				Axial diameter		Length L	Max. length
	D	Tolerance		W	Tolerance	t	l	d	Tolerance		
WSPTO 16	31	$\begin{matrix} 0 \\ -0.013 \end{matrix}$	50	35	$\begin{matrix} +0.018 \\ 0 \end{matrix}$	2	175	16	$\begin{matrix} 0 \\ -0.017 \end{matrix}$	200 300 400	1000
WSPTO 20	35	$\begin{matrix} 0 \\ -0.016 \end{matrix}$	63	4	$\begin{matrix} +0.018 \\ 0 \end{matrix}$	25	29	20	$\begin{matrix} 0 \\ -0.020 \end{matrix}$	300 400 500 600	1000

Model No.	Basic dynamic load rating	Basic static load rating	Basic dynamic rated torque	Basic static rated torque	Basic static rated moment (1)	Spline nut	
	C N	C <sub>0</sub> N	T N*m	T <sub>0</sub> N*m	T <sub>M</sub> N*m	Spline nut g	Spline shaft g/100mm
WSPTO 16	7060	12600	31.4	34.3	67.6	165	160
					393		
WSPTO 20	10200	17800	56.9	55.9	118	225	250
					700		

1N□0.102kgf

Note (1) The top value of the static rated moment T<sub>M</sub> means the value of one nut, and the bottom value represents the value of two nuts in contact.

## WSPTFO Series

An example of the Composition of Model Name & Number

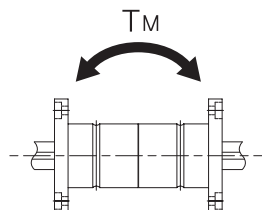
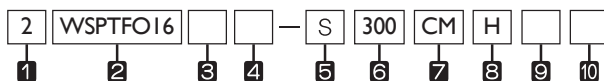

- 1** Number of nuts assembled in one shaft
- 2** Model No.
- 3** Material of nut: **No symbol**-Standard material / **M**-Stainless
- 4** **No symbol**-Standard nut / **E**-Special nut specification
- 5** Type of shaft: **S**-Solid / **H**-Hollow
- 6** Length of shaft
- 7** Symbol of clearance : **CL**-No preload / **CM**-Standard / **CT**-Light preload
- 8** Symbol of precision : **No symbol**-Normal / **H**-Precision / **P**-Super
- 9** Material of shaft : **No symbol**-Standard material / **M**-Stainless
- 10** **No symbol**-Standard shaft / **E**-Special shaft specification

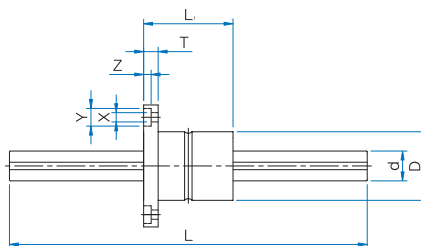
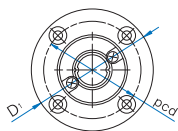

Unit : mm

Model No.	Major dimensions										Length L	Max. length
	Outside diameter		L <sub>i</sub>	D <sub>i</sub>	T	pcd	X x Y x Z	Axial diameter		Length L		
	D	Tolerance						d	Tolerance			
WSPTFO 16	31	0 -0.013	50	51	7	40	4.5x8x4.4	16	0 -0.017	200 300 400	1000	
WSPTFO 20	35	0 -0.016	63	58	9	45	55x95x54	20	0 -0.020	300 400 500 600	1000	

Model No.	Basic dynamic load rating	Basic static load rating	Basic dynamic rated torque	Basic static rated torque	Basic static rated moment (1)	Spline nut	
	C N	C <sub>0</sub> N	T N·m	T <sub>0</sub> N·m	T <sub>M</sub> N·m	Spline nut g	Spline shaft g/100mm
WSPTFO 16	7060	12600	31.4	34.3	67.6	165	160
					393		
WSPTFO 20	10200	17800	56.9	55.9	118	225	250
					700		

1N 0.102kgf

Note (1) The top value of the static rated moment T<sub>M</sub> means the value of one nut, and the bottom value represents the value of two nuts in contact.

## 10 Linear Ball Spline

### 1. Structure and Features

WON Linear Ball Spline is composed of a spline shaft with a groove and a nut. The spline nut has a retainer, a seal, and a ball installed in. It supports smooth motion.

### 2. High load capacity and long life

The raceway surface an R-shape similar to diameter of a ball. Since it is precisely polished, it has a wide area of contact with a ball. Therefore, the device a high load capacity and a long life span.

### 3. Torque transmission with high precision

The groove of shaft and cylinder adjusts a ball at an appropriate contact angle. Therefore, with one shaft, it is possible to transmit torque.

In addition, by setting the gap of the rotation direction for preload to zero, it is possible to increase rigidity and determine an accurate position of rotation.

### 4. High speed movement and high speed rotation

The cylinder of a linear ball spline is compact and is balanced well. Therefore, it has good performance in high-speed motion or high-speed rotation.

### 5. Product components

WON Linear Ball Spline has eight different types (8 to 40) of sizes, and has two different types of nut shapes (cylinder type:WLS, flange type:WLSF).

If you need a linear ball spline with a different material, please contact us.

### 6. Easy further processing

WON Linear Ball Spline has a groove installed in its round shaft. Therefore, the device supports multiple types of processing easily and is applicable in wide areas.

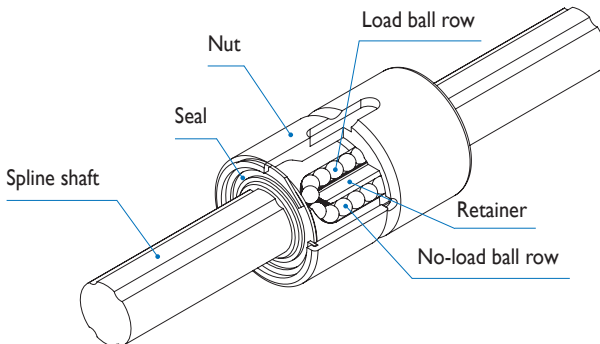



Figure 12. Structure of linear ball spline

Classification	Type	Shape and Features	Shape and Features
Cylinder Type	WLS		It has a general spline nut that has a key groove helping to fix the position of a rotational direction accurately.
Flange Type	WLSF		Flange Type - As a round flange type, it can be installed easily.

It is possible to select a different type of WON Linear Ball Spline depending on a use. A seal is basically installed in any type of nut.



## WLS Series

An example of the Composition of Model Name & Number

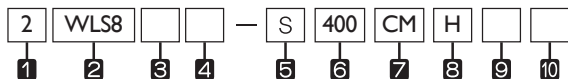

- 1 Number of nuts assembled in one shaft
- 2 Model No.
- 3 Material of nut: **No symbol**-Standard material/**M**-Stainless
- 4 **No symbol**-Standard nut / **E**-Special nut specification
- 5 Type of shaft: **S**-Solid / **H**-Hollow
- 6 Length of shaft
- 7 Symbol of clearance : **CL**-No preload / **CM**-Standard / **CT**-Light preload
- 8 Symbol of precision : **No symbol**-Normal / **H**-Precision / **P**-Super
- 9 Material of shaft : **No symbol**-Standard material / **M**-Stainless
- 10 **No symbol**-Standard shaft / **E**-Special shaft specification



Model No.	Major dimensions										
	Outside diameter		Length		Dimension of key groove				O	Axial diameter	
	D	Tolerance	L <sub>i</sub>	Tolerance	W	Tolerance	t	l		d	Tolerance
WLS 8	16	0 -0.011	25	0 -0.011	25	+0.014 0	1.2	105	15	8	0
WLS 10	21	0 -0.013	33		3		1.5	13	15	10	-0.015
WLS 13	24	0 -0.016	36	0 -0.019	3	+0.018 0	1.5	15	15	13	0 -0.018
WLS 16	31		50		35		2	175	2	16	
WLS 20	35	0 -0.016	63	0 -0.019	4	+0.018 0	2.5	29	2	20	0 -0.021
WLS 25	42		71		4		2.5	36	3	25	
WLS 30	47	0 -0.019	80	0 -0.025	4	+0.018 0	2.5	42	3	30	0 -0.025
WLS 40	64		100		6		3.5	52	4	40	

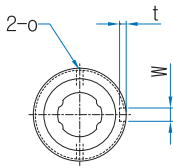

WLS 8~13

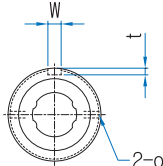

WLS 16~40

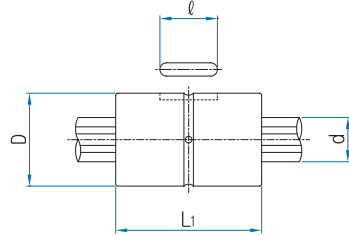

Unit : mm

Basic dynamic load rating <b>C</b> N	Basic static load rating <b>Co</b> N	Basic dynamic rated torque <b>T</b> N·m	Basic static rated torque <b>To</b> N·m	Basic static rated torque <b>T<sub>M</sub></b> N·m	Spline nut		Model No.
					Spline nut g	Spline shaft g/100mm	
1,450	2,870	2.1	3.7	7.4	23	38	WLS 8
2,730	5,070	4.4	8.2	18.0	54	60	WLS 10
2,670	4,890	21	39.2	13.7	70	100	WLS 13
6,120	11,200	60	110	46	150	150	WLS 16
8,900	16,300	105	194	110	220	240	WLS 20
12,800	23,400	189	346	171	330	370	WLS 25
18,600	23,200	307	439	181	360	540	WLS 30
30,800	37,500	647	934	358	950	960	WLS 40

IN 0.102kgf

## WLSF Series

An example of the Composition of Model Name & Number

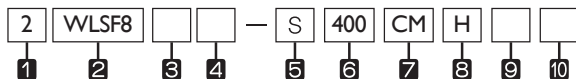

- 1 Number of nuts assembled in one shaft
- 2 Model No.
- 3 Material of nut: **No symbol**-Standard material/**M**-Stainless
- 4 **No symbol**-Standard nut / **E**-Special nut specification
- 5 Type of shaft: **S**-Solid / **H**-Hollow
- 6 Length of shaft
- 7 Symbol of clearance : **CL**-No preload / **CM**-Standard / **CT**-Light preload
- 8 Symbol of precision : **No symbol**-Normal / **H**-Precision / **P**-Super
- 9 Material of shaft : **No symbol**-Standard material / **M**-Stainless
- 10 **No symbol**-Standard shaft / **E**-Special shaft specification



Model No.	Major dimensions											
	Outside diameter		Length		D <sub>1</sub>	T	PCD	X x Y x Z	L <sub>1</sub>	o	Axial diameter	
	D	Tolerance	L <sub>1</sub>	Tolerance							d	Tolerance
WLSF 8	16	0 -0.011	25	0 -0.2	32	5	24	34x65x33	75	1.5	8	0 -0.015
WLSF 10	21	0 -0.013	33		42	6	32	45x8x44	105	1.5	10	
WLSF 13	24		36		44	7	33	45x8x44	11	1.5	13	0 -0.018
WLSF 16	31	50	50		7	40	45x8x44	18	2	16		
WLSF 20	35	0 -0.016	63	0 -0.3	58	9	45	55x95x54	225	2	20	0 -0.021
WLSF 25	42		71		65	9	52	55x95x54	265	3	25	
WLSF 30	47		80		75	10	60	66x11x65	30	3	30	
WLSF 40	64		0 -0.019		100	100	14	82	9x14x86	36	4	40

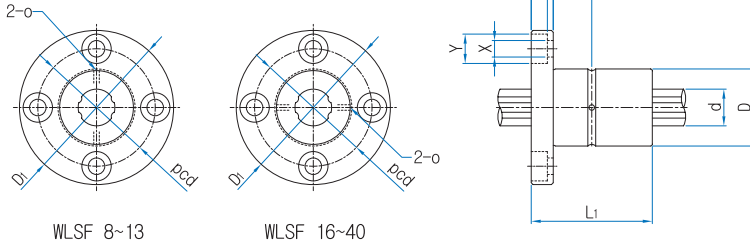

Unit : mm

Basic dynamic load rating <b>C</b> <b>N</b>	Basic static load rating <b>C<sub>0</sub></b> <b>N</b>	Basic dynamic rated torque <b>T</b> <b>N·m</b>	Basic static rated torque <b>T<sub>0</sub></b> <b>N·m</b>	Basic static rated torque <b>T<sub>M</sub></b> <b>N·m</b>	Spline nut		Model No.
					Spline nut <b>g</b>	Spline shaft <b>g/100mm</b>	
1,450	2,870	2.1	3.7	7.4	42	38	WLSF 8
2,730	5,070	4.4	8.2	18.0	94	60	WLSF 10
2,670	4,890	21	39.2	13.7	100	100	WLSF 13
6,120	11,200	60	110	46	200	150	WLSF 16
8,900	16,300	105	194	110	330	240	WLSF 20
12,800	23,400	189	346	171	450	370	WLSF 25
18,600	23,200	307	439	181	550	540	WLSF 30
30,800	37,500	647	934	358	1,410	960	WLSF 40

IN 0.102kgf



**WON**  
LINEAR MOTION SYSTEM

# Cross Roller Guide Way Contents

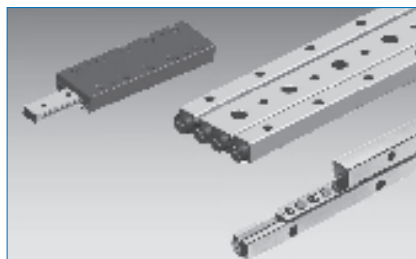

<b>1</b>	Structure and Features of Cross Roller Guide Way	
	1. Precise and fine linear motion.....	182
	2. Low noise.....	182
	3. High load capacity.....	182
<b>2</b>	Structures and Features of Anti-Creep Cross Roller Guide Way	
	1. Responses to multiple types of operation.....	183
	2. Low noise and smooth movement.....	183
	3. High load capacity based on complete compatibility of installation dimensions.....	183
<b>3</b>	Types and Features.....	184
<b>4</b>	Precision .....	185
<b>5</b>	Load rating and life.....	186
<b>6</b>	Preload.....	188
<b>7</b>	Precision of mounting surface.....	189
<b>8</b>	How to install.....	189
<b>9</b>	Lubrication and Dust Proof.....	191
<b>10</b>	Caution for Use .....	192

# I Structure and Features of Cross Roller Guide Way

WON Cross Roller Guide Way is composed of the race rail and roller cage precisely polished. For use, the roller cages assembled in the reverse direction of precise roller are put together with the 90°V grooved raceway surface of a race rail. The device has the non-circular and highly-precise linear motion system with low frictional resistance. It is mainly applied to electric discharge machine, optical equipment, measuring equipment, and electronic parts assembly & inspection equipment.

## 1. Precise and fine linear motion

A cross roller guide way has very low frictional resistance and almost no static and dynamic frictional resistance. Therefore, it supports precise and fine linear motion, obtaining stable linear motion in the conditions of light load and low speed.

## 2. Low noise

WON Cross Roller Guide Way has a non-circular linear motion system. Therefore, it has no noise of circulation part. Since its roller cage supports a roller at a certain interval, the device runs smoothly without any noise of contact between rollers. .

## 3. High load capacity

Since a cross roller guide way uses a precise roller as a rolling element, it has high rigidity and a high load capacity.

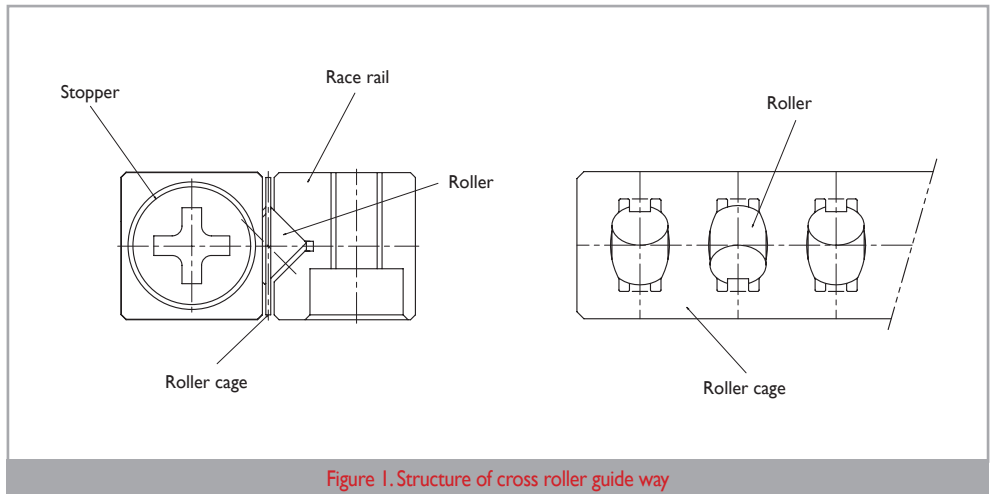
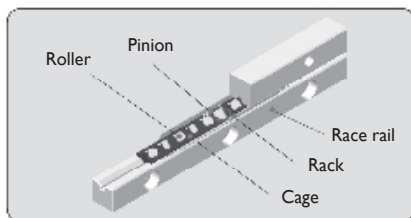

Figure 1. Structure of cross roller guide way

## 2 WON Anti-Creep Structures and Features of Anti-Creep Cross Roller Guide Way

WON Anti-Creep Cross Roller Guide Way is the product with the rack and pinion gear built in a conventional cross roller guide way. Therefore, it has very high precision and the anti-creep protection.



Structure of WON Anti-Creep cross roller guide way

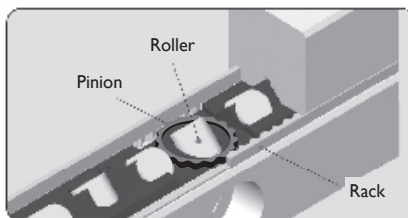

Details of Anti-Creep part

### 1. Responses to multiple types of operation

The anti-creep function makes it possible to respond to very high deceleration and acceleration. Unlike a conventional cross roller guide way, this device is safely applicable in difficult service conditions like vertical axis.

### 2. Low noise and smooth motion

This product adopts a resin cage, rather than a steel cage applied to our other products, in order to minimize the noise of friction between a case and a roller and to implement quiet and smooth running.

### 3. High load capacity based on complete compatibility of installation

This product has a unique structure in which a pinion gear wraps of roller a cage. It has the same quantity of rollers and the same load rating and stroke assembly dimension as a general cross roller guide way, so that it has good compatibility for convenient replacement.<sup>1)</sup>

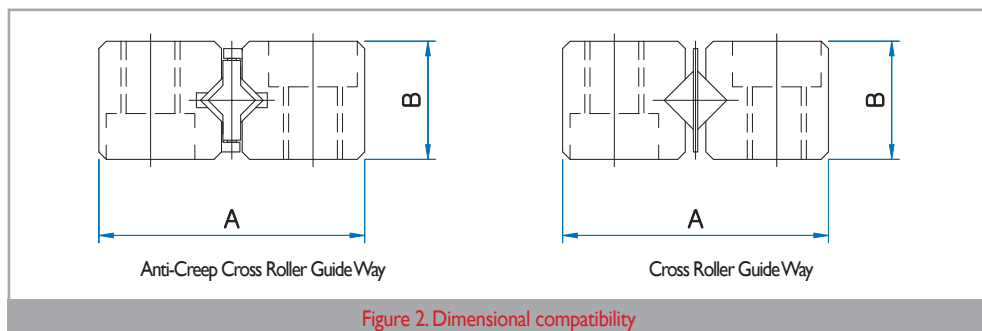
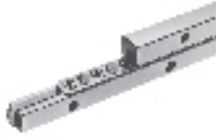

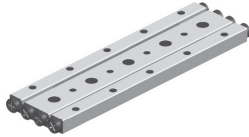
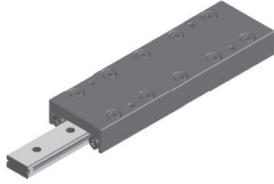
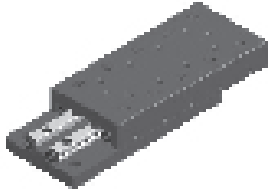

Figure 2. Dimensional compatibility

Note <sup>1)</sup>The model numbers 1 & 2 have a different quantity of rollers.



### 3 Types and Features

		Shape & Feature	
Guide	Roller Cage		<p>In WRG type, the roller cage with the precision rollers crossed at a right angle is put together with the 90° V-grooved raceway of an exclusive rail. By mounting two-roll roller guides in parallel, it is possible to bear any load in all directions, which is imposed on the shaft at a right angle. In addition, since preload can be applied simply, the cross roller guide way can become a light sliding device with no clearance and high rigidity.</p>
	WRG WRGO WRG-AC		
Table	WRGW		
	WRGT		<p>A cross roller table is the compact, highly precise and highly rigid unit guiding a finite linear line. A cross roller guide way is put in between a highly precise table and the base.</p>
	WRGU WR- GU-AC		

## 4 Precision

Precision of WON Cross Roller Guide Way is classified into normal, precision, and super precision types.

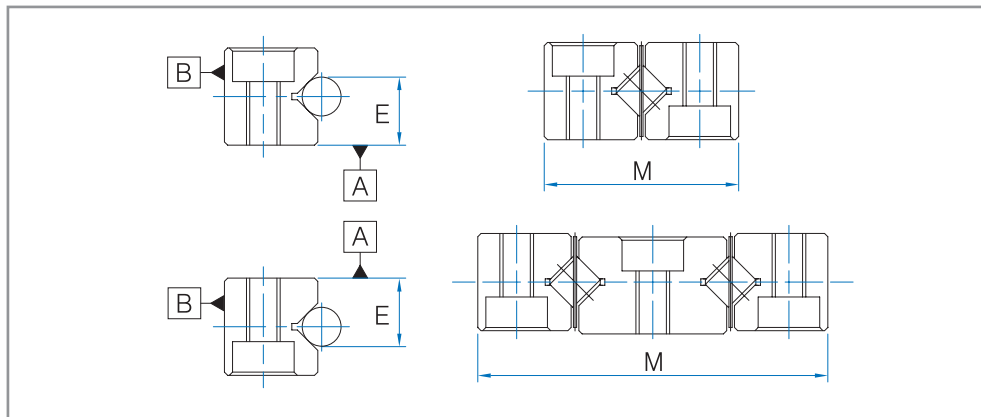

Table 1. Precision of each part of the race rail Unit : mm

Item	Symbol	Class of precision		
		Normal	Precision	Super Precision
		No symbol	H	P
Parallelism of the race rail for □&□ sides		See Table 2.		
Dimensional tolerance of the height E		±0.02		±0.01
Difference of the height E		0.02	0.01	0.005
Tolerance of M		0	0	0
		-0.2	-0.1	-0.1

Table 2. Parallelism of the race rail for □&□ sides Unit : mm

Length of race rail	Class of precision		
	Normal (No symbol)	Precision (H)	Super Precision (P)
Length > 200	8	4	2
200 ≤ length < 400	10	5	3
400 ≤ length < 600	14	7	4
600 ≤ length < 800	15	9	5
800 ≤ length	20	10	5

Note) The difference of the height E is applied to four race rails used on the same plane.

## 5 Load rating and life

As for the basic load rating C and Co, the basic load rating of the running-roller count (Z) actually applied is calculated with the basic load rating Cz and Coz equivalent to one running roller.

Basic dynamic load rating

$$C = \left(\frac{Z}{2}\right)^{\frac{3}{4}} \cdot Cz$$

Basic static load rating

$$Co = \left(\frac{Z}{2}\right) \cdot Coz \quad * \left(\frac{Z}{2}\right) = \text{Removal of decimals}$$

Rating life refers to a total travel distance that 90% in one group of linear motion systems, each of which runs under the same condition, can reach without flaking. After the basic dynamic load rating is calculated in the above formula, it is possible to calculate the life of a cross roller guide way in the following formula.

$$L = \left[ \left( \frac{f_H \cdot f_T}{f_W} \right) \cdot \left( \frac{C}{P_C} \right) \right]^{\frac{10}{3}} \cdot 100$$

Where L : basic load rating (km)  
 C : basic dynamic load rating (kN)  
 Pc : Calculated load (kN)  
 fH : Hardness factor  
 fT : Temperature factor  
 fW : Load factor

If stroke length and the number of strokes per minute are given, it is possible to calculate a service life in the following formula.

$$L_h = \frac{L \times 10^3}{2 \times l_s \times n_1 \times 60}$$

Where Lh : Rating life (hr)  
 ls : Stroke length (m)  
 n1 : Number of strokes per minute (o.p.m.)

Table 3. Hardness factor

A type of race rail	$f_H$
Carbon steel race rail	1
Stainless steel race rail	0.8

Table 4. Temperature factor

Temperature of linear motion system ( $^{\circ}\text{C}$ )	$f_T$
100	1.00
120	0.97
140	0.93
160	0.88
180	0.82

Table 5. Load factor

Impacts & vibration	Velocity (V)	Measured value of vibration (G)	$f_W$
No external impacts and vibration	Low speed $V \leq 15\text{m/mim}$	$G \leq 0.5$	1.0 ~ 1.5
Very weak impacts and vibration	Middle speed $15 < V \leq 60\text{m/mim}$	$0.5 \leq G \leq 1.0$	1.5 ~ 2.0
External impacts and vibration	High speed $V > 60\text{m/mim}$	$1.0 \leq G \leq 2.0$	2.0 ~ 3.5

## 6 Preload

If a cross roller guide way has no appropriate level of preload, it is impossible to obtain the precision needed, or it is possible to cause scratches or shorten its service life. Therefore, fasten an adjustment bolt by checking an allowable preload level.

(\* Adjust an adjustment bolt in the same line with a roller.)

Table 6. Allowable preload level of roller cage in the row I

Unit: □

Model No.	R1	R2	R3	R4	R5	R9
Allowable preload	-2	-3	-4	-5	-7	-10

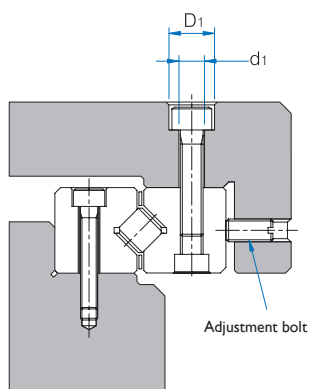
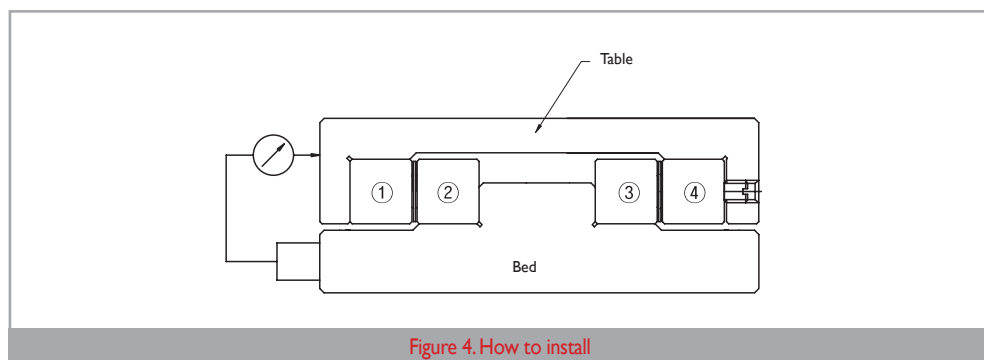

Figure 3. An example of preload adjustment

## 7 Precision of mounting surface

To obtain a certain level of travel precision, it is required for the mounting face of a race rail to secure more than a level of precision described in Table 1. Generally, polishing process is applied.

## 8 How to install



- 1) Place the mounting surfaces of the race rails □, □, and □ closely and accurately on the bed and table and connect them completely.
- 2) Connect the race rail □ temporarily with the table and secure a gap enough to push a roller cage into the side.
- 3) Set a dial gauge as shown in Figure 4. Lightly fasten an adjustment bolt until the table has no runout in order to obtain a certain amount of stroke. Set the dial gauge to zero.
- 4) Place the roller cage at the center as shown in Figure 5. Fasten the adjustment bolt with a torque wrench until the dial gauge shows a certain amount of displacement that represents an allowable preload level. Fasten the mounting bolt of the race rail □ completely.
- 5) Slide the table left and right and fasten another adjustment bolt and mounting bolt (a,e) in the same way as above. Now the installation is complete.

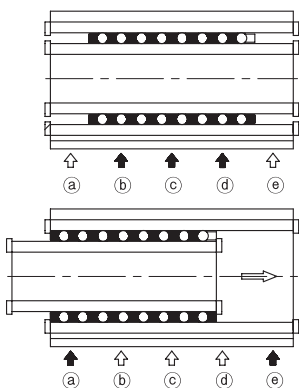
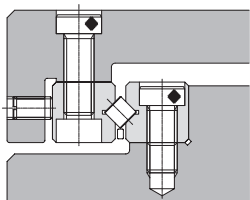
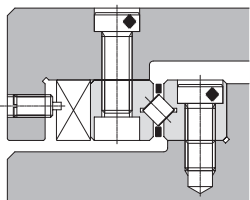

Figure 5. Procedure of fastening an adjustment bolt



Generally, push the rail with the adjustment bolt.



If precision and rigidity are needed, use a holding bar.

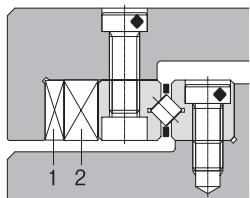

In particular, if high precision and high rigidity are needed, use tapered gibs 1 and 2.

Figure 6. An example of clearance adjustment

## 9 Lubrication and Dust Proof

WON Cross Roller Guide Way (WRGT, WRGU) is already filled with lithium grease. If you need to refill, it is recommended to use the same type of grease.

If a large amount of foreign substances or dust float, or if a cross roller guide way is exposed to relatively big foreign substances like cutting tips or sand, it is recommended to attach a cover to protect the device.

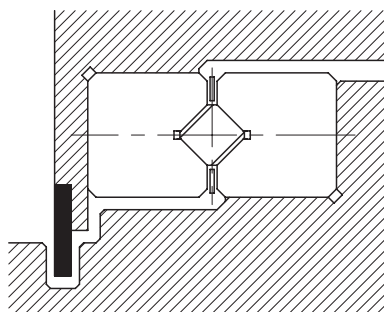

Figure 7.



## 10 Caution for Use

---

### 1. Installation

If the mounting surface is polished with lower than a required level of precision, or an inappropriate preload level is applied, a race rail can face torsion. In this case, asymmetric load, race rail wear, and a shortened service life occur. Therefore, it is recommended to meet the required precision of the polished surface and level of preload.

### 2. Stopper

Stoppers are installed on both ends of a race rail only for the purpose of preventing the separation of a roller cage. Therefore, it is required to install a table stopper separately.

### 3. Use of an equal set

As for WON Cross Roller Guide Way, WRG type has one set of four race rails, and WRGW type one set of three race rails.

The V-groove difference of each type is adjusted in the set. Therefore, a combination of different sets can cause an error that degrades precision and shortens a service life. Be careful.

## Roller Cage

An example of the composition of model name & number

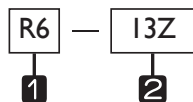

- 1** Model No.
- 2** Number of rollers

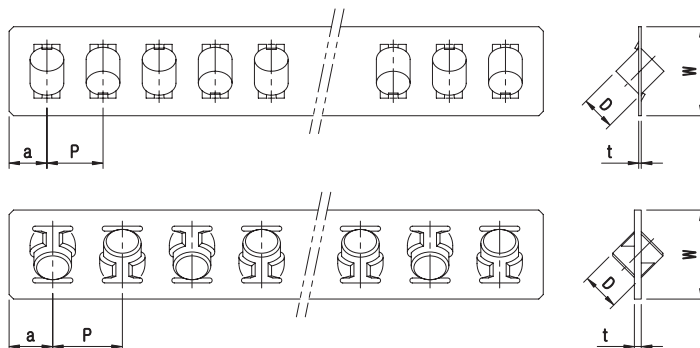
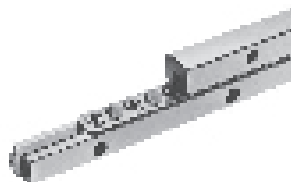

Unit : mm

Model No.	D	t	W	P	a	Cz(kN)	Coz(kN)
R1	1.5	0.2	3.8	2.5	2	0.152	0.153
R2	2	0.25	5	4	2.5	0.276	0.271
R3	3	0.3	7	5	3	0.639	0.611
R4	4	0.3	10.5	7	4.5	1.38	1.35
R6	6	0.6	13.5	10	6	3.78	3.78
R9	9	1.0	19	14	7.5	9.53	9.48

1N  $\approx$  0.102kgf

## WRG Type

An example of the composition of model name & number

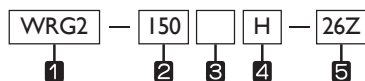

- 1** Model No.
- 2** Length of race rail
- 3** No symbol – Standard race rail / E-Special specification of race rail
- 4** Symbol of precision: No symbol – Normal / H-Precision / P-Super precision
- 5** Number of rollers

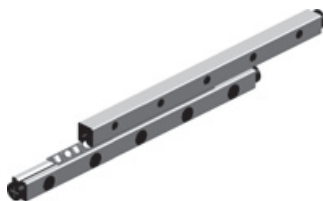

Model No.	Max. stroke	D	No. of rollers Z	Main dimensions										
				L	A	B	C	M x P	N					
WRG 1020	12	1.5	5	20	8.5	4	3.8	1 X 10	5					
WRG 1030	22		7	30				2 X 10						
WRG 1040	27		10	40				3 X 10						
WRG 1050	32		13	50				4 X 10						
WRG 1060	37		16	60				5 X 10						
WRG 1070	42		19	70				6 X 10						
WRG 1080	52		21	80				7 X 10						
WRG 2030	18	2	5	30	12	6	5.5	1 X 15	7.5					
WRG 2045	24		8	45				2 X 15						
WRG 2060	30		11	60				3 X 15						
WRG 2075	44		13	75				4 X 15						
WRG 2090	50		16	90				5 X 15						
WRG 2105	64		18	105				6 X 15						
WRG 2120	70		21	120				7 X 15						
WRG 2135	84		23	135				8 X 15						
WRG 2150	90		26	150				9 X 15						
WRG 2165	96		29	165				10 X 15						
WRG 2180	102		32	180				11 X 15						
WRG 3050	28		3	7				50		18	8	8.3	1 X 25	12.5
WRG 3075	48			10				75					2 X 25	
WRG 3100	58			14				100					3 X 25	
WRG 3125	78	17		125	4 X 25									
WRG 3150	88	21		150	5 X 25									
WRG 3175	108	24		175	6 X 25									
WRG 3200	118	28		200	7 X 25									
WRG 3225	138	31		225	8 X 25									
WRG 3250	148	35		250	9 X 25									
WRG 3275	168	38		275	10 X 25									
WRG 3300	178	42		300	11 X 25									
WRG 3325	198	45		325	12 X 25									
WRG 3350	208	49		350	13 X 25									

Note (1) I SET (Race rail: 4EA, Roller cage: 2EA, Stopper: 8EA)

(2) Basic load rating is based on I set.

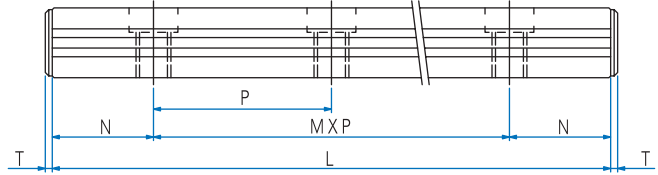
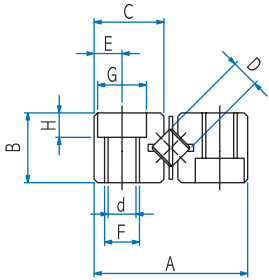

Unit : mm

Dimensions						Basic load rating		Mass (ISET) g	Model No.
E	F	d	G	H	T	Dynamic C (kN)	Static Co (kN)		
1.8	M2	1.65	3	1.4	1.5	0.46	0.61	9	WRG 1020
						0.63	0.92	13	WRG 1030
						0.95	1.53	18	WRG 1040
						1.09	1.84	22	WRG 1050
						1.37	2.45	26	WRG 1060
						1.50	2.75	30	WRG 1070
						1.63	3.06	35	WRG 1080
2.5	M3	2.55	4.4	2	2	0.84	1.08	28	WRG 2030
						1.46	2.17	43	WRG 2045
						1.74	2.71	57	WRG 2060
						2.01	3.25	71	WRG 2075
						2.52	4.34	85	WRG 2090
						2.76	4.88	98	WRG 2105
						3.00	5.42	112	WRG 2120
						3.23	5.96	126	WRG 2135
						3.68	7.05	140	WRG 2150
						3.90	7.59	153	WRG 2165
4.32	8.67	166	WRG 2180						
3.5	M4	3.30	6	3.1	2.5	2.71	3.67	98	WRG 3050
						4.06	6.11	148	WRG 3075
						5.28	8.55	195	WRG 3100
						5.86	9.78	242	WRG 3125
						6.98	12.2	289	WRG 3150
						8.05	14.7	336	WRG 3175
						9.08	17.1	384	WRG 3200
						9.58	18.33	431	WRG 3225
						10.56	20.8	478	WRG 3250
						11.52	23.2	525	WRG 3275
						12.45	25.7	572	WRG 3300
						12.91	26.9	619	WRG 3325
						13.82	29.3	647	WRG 3350

1N ≅ 0.102kgf

## WRG Type

An example of the composition of model name & number

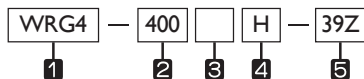

- 1** Model No.
- 2** Length of race rail
- 3** No symbol – Standard race rail / E-Special specification of race rail
- 4** Symbol of precision: No symbol – Normal / H-Precision / P-Super precision
- 5** Number of rollers

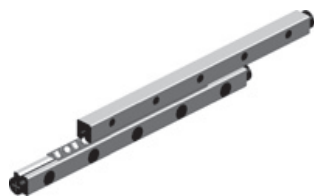

Model No.	Max. stroke	D	No. of rollers Z	Main dimensions					
				L	A	B	C	M x P	N
WRG 4080	58	4	7	80	22	11	10.2	1 X 40	20
WRG 4120	82		11	120					
WRG 4160	106		15	160					
WRG 4200	130		19	200					
WRG 4240	154		23	240					
WRG 4280	178		27	280					
WRG 4320	202		31	320					
WRG 4360	226		35	360					
WRG 4400	250		39	400					
WRG 4440	274		43	440					
WRG 4480	298	47	480						
WRG 6100	56	6	7	100	31	15	14.2	1 X 50	25
WRG 6150	96		10	150					
WRG 6200	136		13	200					
WRG 6250	156		17	250					
WRG 6300	196		20	300					
WRG 6350	216		24	350					
WRG 6400	256		27	400					
WRG 6450	276		31	450					
WRG 6500	316		34	500					
WRG 6550	336		38	550					
WRG 6600	376	41	600						
WRG 9200	118	9	10	200	44	22	20.2	1 X 100	50
WRG 9300	178		15	300					
WRG 9400	238		20	400					
WRG 9500	298		25	500					
WRG 9600	358		30	600					
WRG 9700	418		35	700					
WRG 9800	478		40	800					
WRG 9900	538		45	900					
WRG 91000	598		50	1000					

Note (1) I SET (Race rail: 4EA, Roller cage: 2EA, Stopper: 8EA)

(2) Basic load rating is based on I set.

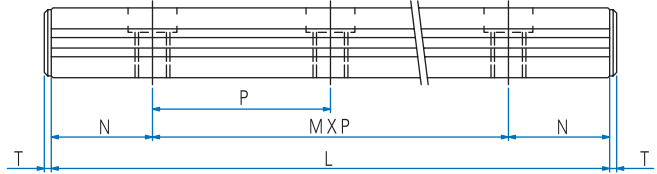
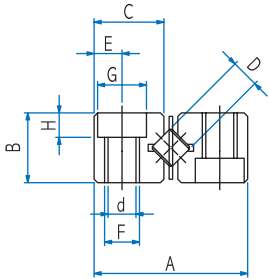

Unit : mm

Dimensions						Basic load rating		Mass (ISET) g	Model No.
E	F	d	G	H	T	Dynamic C (kN)	Static Co (kN)		
4.5	M5	4.3	8	4.2	2.5	5.92	8.10	260	WRG 4080
						8.85	13.5	400	WRG 4120
						11.5	18.9	530	WRG 4160
						14.0	24.3	660	WRG 4200
						16.4	29.7	790	WRG 4240
						18.7	35.1	920	WRG 4280
						20.88	40.5	1050	WRG 4320
						23.0	45.9	1180	WRG 4360
						25.1	51.3	1300	WRG 4400
						27.1	56.7	1430	WRG 4440
29.1	62.1	1530	WRG 4480						
6	M6	5.2	9.5	5.2	3	16.4	22.7	630	WRG 6100
						24.5	37.8	950	WRG 6150
						28.2	45.4	1260	WRG 6200
						35.4	60.5	1570	WRG 6250
						42.1	75.6	1800	WRG 6300
						48.5	90.7	2190	WRG 6350
						51.7	98.3	2490	WRG 6400
						57.8	113	2810	WRG 6450
						63.7	128	3110	WRG 6500
						69.5	143	3420	WRG 6550
72.3	151	3730	WRG 6600						
9	M8	6.8	10.5	6.2	4	62.3	94.8	2710	WRG 9200
						81.1	133	4050	WRG 9300
						107	190	5350	WRG 9400
						123	228	6680	WRG 9500
						147	284	8010	WRG 9600
						162	322	9330	WRG 9700
						184	379	10650	WRG 9800
						198	417	11970	WRG 9900
						219	474	13300	WRG 91000

1N ≅ 0,102kgf

## WRGO Type

An example of the composition of model name & number

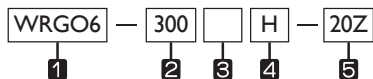

- 1** Model No.
- 2** Length of race rail
- 3** No symbol – Standard race rail / E-Special specification of race rail
- 4** Symbol of precision: No symbol – Normal / H-Precision / P-Super precision
- 5** Number of rollers



Model No.	Max. stroke	D	No. of rollers Z	Main dimensions					
				L	A	B	C	M x P	N
WRGO 6100	56	6	7	100	30	15	14.4	1 X 50	25
WRGO 6150	96		10	150				2 X 50	
WRGO 6200	136		13	200				3 X 50	
WRGO 6250	156		17	250				4 X 50	
WRGO 6300	196		20	300				5 X 50	
WRGO 6350	216		24	350				6 X 50	
WRGO 6400	256		27	400				7 X 50	
WRGO 6450	276		31	450				8 X 50	
WRGO 6500	316		34	500				9 X 50	
WRGO 6550	336		38	550				10 X 50	
WRGO 6600	376	41	600	11 X 50					
WRGO 9200	118	9	10	200	40	20	19.2	1 X 100	50
WRGO 9300	178		15	300				2 X 100	
WRGO 9400	238		20	400				3 X 100	
WRGO 9500	298		25	500				4 X 100	
WRGO 9600	359		30	600				5 X 100	
WRGO 9700	418		35	700				6 X 100	
WRGO 9800	478		40	800				7 X 100	
WRGO 9900	538		45	900				8 X 100	
WRGO 91000	598		50	1000				9 X 100	
WRGO 91100	658		55	1100				10 X 100	
WRGO 91200	718		60	1200				11 X 100	

Note (1) I SET (Race rail: 4EA, Roller cage: 2EA, Stopper: 8EA)

(2) Basic load rating is based on I set.

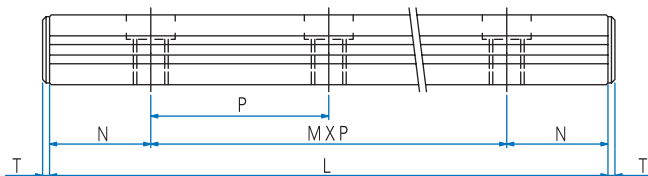
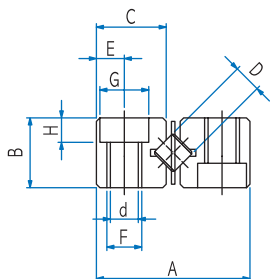

Unit : mm

Dimensions						Basic load rating		Mass (ISET) g	Model No.
E	F	d	G	H	T	Dynamic C (kN)	Static C <sub>0</sub> (kN)		
6	M6	5.2	9.5	5.2	3	16.4	22.7	640	WRGO 6100
						24.5	37.8	940	WRGO 6150
						28.2	45.4	1250	WRGO 6200
						35.4	60.5	1560	WRGO 6250
						42.1	75.6	1860	WRGO 6300
						48.5	90.7	2170	WRGO 6350
						51.7	98.3	2490	WRGO 6400
						57.8	113	2780	WRGO 6450
						63.7	128	3090	WRGO 6500
						69.5	143	3390	WRGO 6550
						72.3	151	3700	WRGO 6600
8	M8	6.8	10.5	6.2	4	62.3	94.8	2280	WRGO 9200
						81.1	133	3400	WRGO 9300
						107	190	4510	WRGO 9400
						123	228	5620	WRGO 9500
						147	284	6740	WRGO 9600
						162	322	7850	WRGO 9700
						184	379	8960	WRGO 9800
						198	417	10070	WRGO 9900
						219	474	11190	WRGO 91000
						232	512	12300	WRGO 91100
						252	569	13410	WRGO 91200

1N ≅ 0.102kgf



## WRG-AC Type

An example of the composition of model name & number

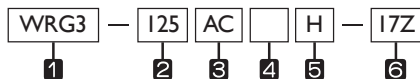

- 1** Model No.
- 2** Length of race rail
- 3** AC-Cage Anti-creep type
- 4** No symbol –Standard race rail / E-Special specification of race rail
- 5** Symbol of precision: No symbol –Normal / H-Precision / P-Super precision
- 6** Number of rollers

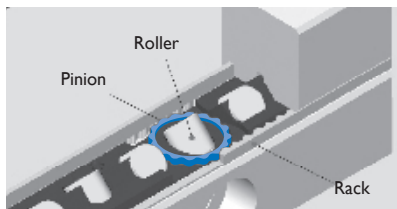

Model No.	Max. stroke	D	No. of rollers Z	Main dimensions					
				L	A	B	C	M x P	N
WRG 2030 AC	18	2	4	30	12	6	5.4	1 X 15	7.5
WRG 2045 AC	24		7	45				2 X 15	
WRG 2060 AC	30		10	60				3 X 15	
WRG 2075 AC	44		12	75				4 X 15	
WRG 2090 AC	50		15	90				5 X 15	
WRG 2105 AC	64		17	105				6 X 15	
WRG 2120 AC	70		20	120				7 X 15	
WRG 2135 AC	84		22	135				8 X 15	
WRG 2150 AC	90		25	150				9 X 15	
WRG 2165 AC	96		28	165				10 X 15	
WRG 2180 AC	102		31	180				11 X 15	
WRG3050AC2	24	4	6	50	18	8	8.6	1x25	12.5
WRG3075AC2	54		8	75				2x25	
WRG3100AC2	66		12	100				3x25	
WRG3125AC2	78		16	125				4x25	
WRG3150AC2	90		20	150				5x25	
WRG3175AC2	100		24	175				6x25	
WRG3200AC2	112		28	200				7x25	
WRG3225AC2	144		30	225				8x25	
WRG 4080 AC	58	4	7	80	22	11	10.2	1 X 40	20
WRG 4120 AC	82		11	120				2 X 40	
WRG 4160 AC	106		15	160				3 X 40	
WRG 4200 AC	130		19	200				4 X 40	
WRG 4240 AC	154		23	240				5 X 40	
WRG 4280 AC	178		27	280				6 X 40	
WRG 4320 AC	202		31	320				7 X 40	
WRG 4360 AC	226		35	360				8 X 40	
WRG 4400 AC	250		39	400				9 X 40	
WRG 4440 AC	274		43	440				10 X 40	
WRG 4480 AC	298		47	480				11 X 40	

Note (1) 1 SET (Race rail: 4EA, Roller cage: 2EA, Stopper: 8EA)

(2) Basic load rating is based on 1 set.

(3) If a stopper is needed, please make separate description.

(4) For the vertical use of the device, please contact us.

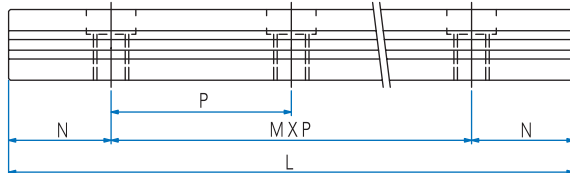
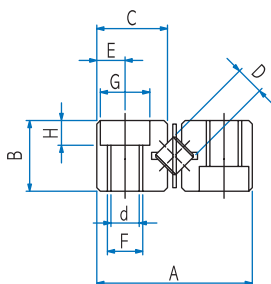

Unit : mm

Dimensions					Basic load rating		Mass (ISET) g	Model No.
E	F	d	G	H	Dynamic C (kN)	Static Co (kN)		
2.5	M3	2.55	4.4	2	0.62	0.73	28	WRG 2030 AC
					0.86	1.10	43	WRG 2045 AC
					1.28	1.83	57	WRG 2060 AC
					1.48	2.20	71	WRG 2075 AC
					1.67	2.56	85	WRG 2090 AC
					1.85	2.93	98	WRG 2105 AC
					2.2	3.66	112	WRG 2120 AC
					2.37	4.03	126	WRG 2135 AC
					2.54	4.39	140	WRG 2150 AC
					2.86	5.13	153	WRG 2165 AC
					3.02	5.49	166	WRG 2180 AC
					3.5	M4	3.30	6
8.20	12.50	144	WRG3075AC2					
11.27	18.75	190	WRG3100AC2					
14.12	25.00	236	WRG3125AC2					
16.81	31.25	281	WRG3150AC2					
19.38	37.50	327	WRG3175AC2					
21.86	43.75	373	WRG3200AC2					
23.06	46.88	418	WRG3225AC2					
4.5	M5	4.3	8	4.2	5.92	8.10	260	WRG 4080 AC
					8.85	13.5	400	WRG 4120 AC
					11.5	18.9	530	WRG 4160 AC
					14.0	24.3	660	WRG 4200 AC
					16.4	29.7	790	WRG 4240 AC
					18.7	35.1	920	WRG 4280 AC
					20.88	40.5	1050	WRG 4320 AC
					23.0	45.9	1180	WRG 4360 AC
					25.1	51.3	1300	WRG 4400 AC
					27.1	56.7	1430	WRG 4440 AC
					29.1	62.1	1530	WRG 4480 AC

1N ≅ 0.102kgf

## WRGW Type

An example of the composition of model name & number

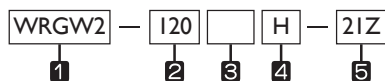

- 1** Model No.
- 2** Length of race rail
- 3** No symbol – Standard race rail / E-Special specification of race rail
- 4** Symbol of precision: No symbol –Normal / H-Precision / P-Super precision
- 5** Number of rollers



Model No.	Max. stroke	D	No. of rollers Z	Main dimensions						
				L	A	t	B <sub>1</sub>	B <sub>2</sub>	C	P <sub>1</sub>
WRGW 1020	12	1.5	5	20	4.5	0.5	17	7.6	3.8	13.4
WRGW 1030	22		7	30						
WRGW 1040	27		10	40						
WRGW 1050	32		13	50						
WRGW 1060	37		16	60						
WRGW 1070	42		19	70						
WRGW 1080	52	21	80							
WRGW 2030	18	2	5	30	6.5	0.5	24	11	5.5	19
WRGW 2045	24		8	45						
WRGW 2060	30		11	60						
WRGW 2075	44		13	75						
WRGW 2090	50		16	90						
WRGW 2105	64		18	105						
WRGW 2120	70	21	120							
WRGW 3050	28	3	7	50	8.5	0.5	36	16.6	8.3	29
WRGW 3075	48		10	75						
WRGW 3100	58		14	100						
WRGW 3125	78		17	125						
WRGW 3150	88		21	150						
WRGW 3175	108		24	175						
WRGW 3200	118	28	200							
WRGW 4080	58	4	7	80	11.5	0.5	44	20.4	10.2	35
WRGW 4120	82		11	120						
WRGW 4160	106		15	160						
WRGW 4200	130		19	200						
WRGW 4240	154		23	240						
WRGW 4280	178		27	280						

Note (1) 1 SET (Race rail: 4EA, Roller cage: 2EA, Stopper: 8EA)

(2) Basic load rating is based on 1 set.

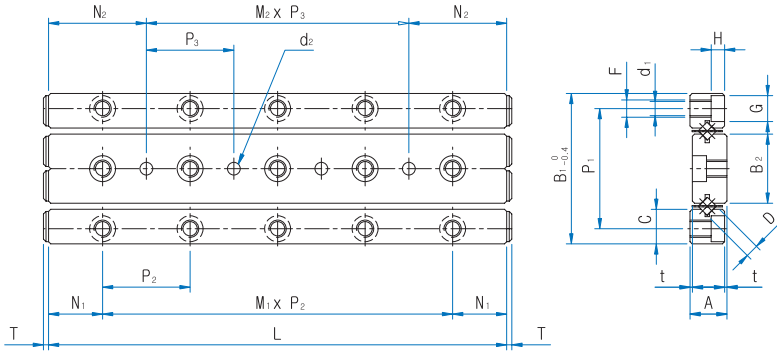

Unit : mm

Dimensions										Basic load rating		Mass	Model No.
$M_1 \times P_2$	$N_1$	$M_2 \times P_3$	$N_2$	F	$d_1$	G	H	T	$d_2$	Dynamic C (kN)	Static Co (kN)	(ISET) $\delta$	
1 X 10		-								0.46	0.61	9	WRGW 1020
2 X 10		1 X 10								0.63	0.92	14	WRGW 1030
3 X 10		2 X 10								0.95	1.53	18	WRGW 1040
4 X 10	5	3 X 10	10	M2	1.65	3	1.4	1.5	2	1.09	1.84	22	WRGW 1050
5 X 10		4 X 10								1.37	2.45	26	WRGW 1060
6 X 10		5 X 10								1.50	2.75	31	WRGW 1070
7 X 10		6 X 10								1.63	3.06	35	WRGW 1080
1 X 15		-								0.84	1.08	29	WRGW 2030
2 X 15		1 X 15								1.46	2.17	43	WRGW 2045
3 X 15		2 X 15								1.74	2.71	58	WRGW 2060
4 X 15	7.5	3 X 15	15	M3	2.55	4.4	2	2	3	2.01	3.25	72	WRGW 2075
5 X 15		4 X 15								2.52	4.34	83	WRGW 2090
6 X 15		5 X 15								2.76	4.38	99	WRGW 2105
7 X 15		6 X 15								3.00	5.42	113	WRGW 2120
1 X 25		-								2.71	3.67	101	WRGW 3050
2 X 25		1 X 25								4.06	6.11	142	WRGW 3075
3 X 25		2 X 25								5.28	8.55	197	WRGW 3100
4 X 25	12.5	3 X 25	25	M4	3.3	6	3.1	2.5	4	5.86	9.78	240	WRGW 3125
5 X 25		4 X 25								6.98	12.2	292	WRGW 3150
6 X 25		5 X 25								8.06	14.7	339	WRGW 3175
7 X 25		6 X 25								9.08	17.1	387	WRGW 3200
1 X 40		-								5.92	8.10	263	WRGW 4080
2 X 40		1 X 40								8.85	13.5	401	WRGW 4120
3 X 40		2 X 40								11.5	18.9	530	WRGW 4160
4 X 40	20	3 X 40	40	M5	4.3	8	4.2	2.5	5	14.0	24.3	660	WRGW 4200
5 X 40		4 X 40								16.4	29.7	787	WRGW 4240
6 X 40		5 X 40								18.7	35.1	920	WRGW 4280

1N  $\approx$  0.102kgf

## WRGT Series

An example of the composition of model number

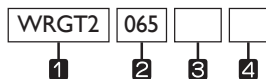

- 1** Model No.
- 2** Length of table
- 3** No symbol – Base tap type
- 4** No symbol- Standard specification / E-Special processing specification

For other sizes and specifications than those in the table of dimensions, please contact us.



Model No.	Main dimensions				Dimensions of the table surface										
	Max. stroke	Width W ±0.1	Height M ±0.1	Length L	Position of table attachment tap						F <sub>1</sub>	nX F <sub>1</sub>	D <sub>1</sub>	B <sub>1</sub>	G <sub>1</sub>
					B	F	n X F	G	S	F <sub>1</sub>					
WRGT 1025	12			25		18	1 X 18	3.5				1 X 10			
WRGT 1035	18			35		28	1 X 28	3.5				2 X 10			
WRGT 1045	25			45		20	1 X 20	12.5				3 X 10			
WRGT 1055	32	20	8	55	14	30	1 X 30	12.5	M2.6	10		4 X 10	4.1	12.4	7.5
WRGT 1065	40			65		20	2 X 20	12.5				5 X 10			
WRGT 1075	45			75		30	1 X 30	22.5				6 X 10			
WRGT 1085	50			85		30	2 X 30	12.5				7 X 10			
WRGT 2035	18			35		28	1 X 28	3.5				1 X 15			
WRGT 2050	30			50		43	1 X 43	3.5				2 X 15			
WRGT 2065	40			65		30	1 X 30	17.5				3 X 15			
WRGT 2080	50	30	12	80	22	45	1 X 45	17.5	M3	15		4 X 15	6	20	10
WRGT 2095	60			95		30	2 X 30	17.5				5 X 15			
WRGT 2110	70			110		45	1 X 45	32.5				6 X 15			
WRGT 2125	80			125		45	2 X 45	17.5				7 X 15			
WRGT 3055	30			55		40	1 X 40	7.5				1 X 25			
WRGT 3080	45			80		65	1 X 65	7.5				2 X 25			
WRGT 3105	60			105		50	1 X 50	27.5				3 X 25			
WRGT 3130	75	40	16	130	30	75	1 X 75	27.5	M4	25		4 X 25	7.5	28.4	15
WRGT 3155	90			155		50	2 X 50	27.5				5 X 25			
WRGT 3180	105			180		75	1 X 75	52.5				6 X 25			
WRGT 3205	130			205		75	2 X 75	27.5				7 X 25			

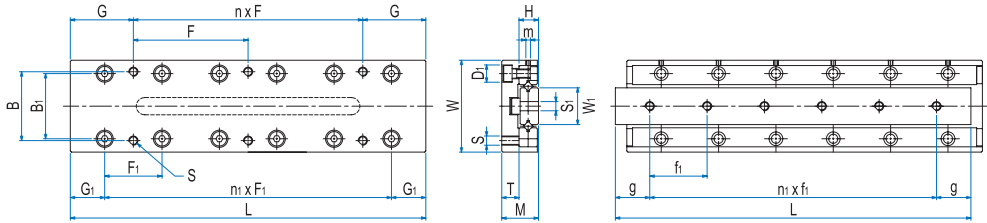

Unit: □

Dimensions of the side				Dimensions of the base side position of attachment hole				Basic load rating		Precision		Model No.
T	H	W <sub>1</sub>	m	S <sub>1</sub>	f <sub>1</sub>	n <sub>2</sub> x f <sub>1</sub>	g	Dynamic C (kN)	Static C <sub>0</sub> (kN)	∠C	∠D	
7.5	4	6.6	M2	M2.6	7.5	2 X 7.5	5	0.46	0.61	2	4	WRGT 1025
					10.0	2 X 10	7.5	0.63	0.92	2	4	WRGT 1035
					10.0	3 X 10	7.5	0.95	1.53	2	5	WRGT 1045
					10.0	4 X 10	7.5	1.09	1.84	2	5	WRGT 1055
					10.0	5 X 10	7.5	1.23	2.14	2	5	WRGT 1065
					10.0	6 X 10	7.5	1.50	2.75	2	5	WRGT 1075
					10.0	7 X 10	7.5	1.63	3.06	2	5	WRGT 1085
11.5	6	12.0	M2	M3	20.0	1 X 20	7.5	0.84	1.08	2	4	WRGT 2035
					15.0	2 X 15	10	1.17	1.63	2	4	WRGT 2050
					15.0	3 X 15	10	1.46	2.17	2	5	WRGT 2065
					15.0	4 X 15	10	2.01	3.25	2	5	WRGT 2080
					15.0	5 X 15	10	2.27	3.79	2	5	WRGT 2095
					15.0	6 X 15	10	2.52	4.34	2	5	WRGT 2110
15.5	8	16.0	M2	M4	35.0	1 X 35	10	2.71	3.67	2	5	WRGT 3055
					25.0	2 X 25	15	4.06	6.11	2	5	WRGT 3080
					25.0	3 X 25	15	4.68	7.33	3	6	WRGT 3105
					25.0	4 X 25	15	5.86	9.78	3	6	WRGT 3130
					25.0	5 X 25	15	6.98	12.2	3	6	WRGT 3155
					25.0	6 X 25	15	8.05	14.7	3	6	WRGT 3180
					25.0	7 X 25	15	8.57	15.9	3	6	WRGT 3205

1N ≅ 0.102kgf

## WRGT-B Series

An example of the composition of model number

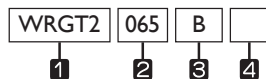

- 1 Model No.
- 2 Length of table
- 3 B-Base hole type
- 4 No symbol-Standard specification / E-Special processing specification



For other sizes and specifications than those in the table of dimensions, please contact us.

Model No.	Main dimensions				Dimensions of the table surface										
	Max. stroke	Width W ±0.1	Height M ±0.1	Length L	Position of table attachment tap						F <sub>1</sub>	n <sub>1</sub> X F <sub>1</sub>	D <sub>1</sub>	B <sub>1</sub>	G <sub>1</sub>
					B	F	n X F	G	S						
WRGT 1025B	12			25		18	1 X 18	3.5			1 X 10				
WRGT 1035B	18			35		28	1 X 28	3.5			2 X 10				
WRGT 1045B	25			45		20	1 X 20	12.5			3 X 10				
WRGT 1055B	32	20	8	55	14	30	1 X 30	12.5	M2.6	10	4 X 10	4.1	12.4	7.5	
WRGT 1065B	40			65		20	2 X 20	12.5			5 X 10				
WRGT 1075B	45			75		30	1 X 30	22.5			6 X 10				
WRGT 1085B	50			85		30	2 X 30	12.5			7 X 10				
WRGT 2035B	18			35		28	1 X 28	3.5			1 X 15				
WRGT 2050B	30			50		43	1 X 43	3.5			2 X 15				
WRGT 2065B	40			65		30	1 X 30	17.5			3 X 15				
WRGT 2080B	50	30	12	80	22	45	1 X 45	17.5	M3	15	4 X 15	6	20	10	
WRGT 2095B	60			95		30	2 X 30	17.5			5 X 15				
WRGT 2110B	70			110		45	1 X 45	32.5			6 X 15				
WRGT 2125B	80			125		45	2 X 45	17.5			7 X 15				
WRGT 3055B	30			55		40	1 X 40	7.5			1 X 25				
WRGT 3080B	45			80		65	1 X 65	7.5			2 X 25				
WRGT 3105B	60			105		50	1 X 50	27.5			3 X 25				
WRGT 3130B	75	40	16	130	30	75	1 X 75	27.5	M4	25	4 X 25	7.5	28.4	15	
WRGT 3155B	90			155		50	2 X 50	27.5			5 X 25				
WRGT 3180B	105			180		75	1 X 75	52.5			6 X 25				
WRGT 3205B	130			205		75	2 X 75	27.5			7 X 25				

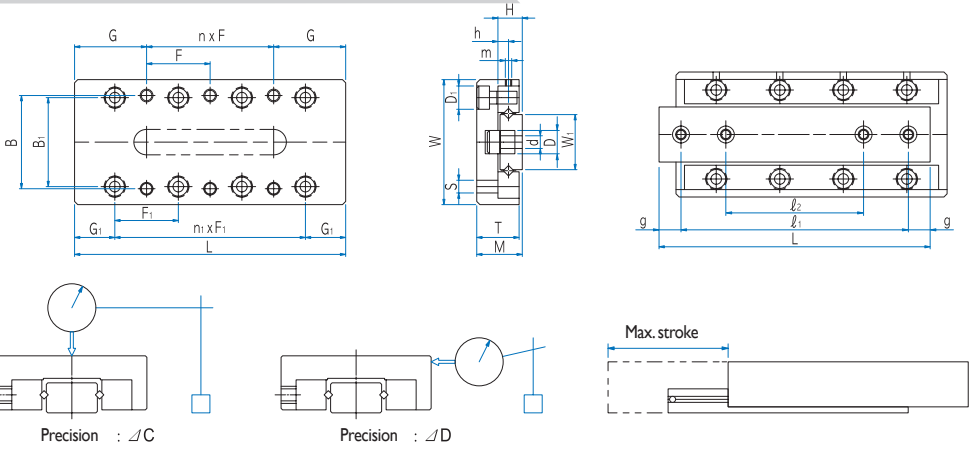

Unit: □

Dimensions of the side				Dimensions of the base side position of attachment hole			Basic load rating		Precision		Model No.	
T	H	W <sub>1</sub>	m	d X D X h	l <sub>1</sub>	l <sub>2</sub>	g	Dynamic C (kN)	Static C <sub>0</sub> (kN)	ΔC		ΔD
7.5	4	6.6	M2	25X4.1X22	18	-	3.5	0.46	0.61	2	4	WRGT 1025B
					25	-	5.0	0.63	0.92	2	4	WRGT 1035B
					38	25	3.5	0.95	1.53	2	5	WRGT 1045B
					48	29	3.5	1.09	1.84	2	5	WRGT 1055B
					55	31	5.0	1.23	2.14	2	5	WRGT 1065B
					65	35	5.0	1.50	2.75	2	5	WRGT 1075B
					75	40	5.0	1.63	3.06	2	5	WRGT 1085B
11.5	6	12.0	M2	35X6X32	25	-	5.0	0.84	1.08	2	4	WRGT 2035B
					35	-	7.5	1.17	1.63	2	4	WRGT 2050B
					55	33	5.0	1.46	2.17	2	5	WRGT 2065B
					70	40	5.0	2.01	3.25	2	5	WRGT 2080B
					85	45	5.0	2.27	3.79	2	5	WRGT 2095B
					95	50	7.5	2.52	4.34	2	5	WRGT 2110B
15.5	8	16.0	M2	45X75X42	110	55	7.5	2.76	4.88	2	5	WRGT 2125B
					40	-	7.5	2.71	3.67	2	5	WRGT 3055B
					68	43	6.0	4.06	6.11	2	5	WRGT 3080B
					90	55	7.5	4.68	7.33	3	6	WRGT 3105B
					115	65	7.5	5.86	9.78	3	6	WRGT 3130B
					140	95	7.5	6.98	12.2	3	6	WRGT 3155B
				165	85	7.5	8.05	14.7	3	6	WRGT 3180B	
				190	90	7.5	8.57	15.9	3	6	WRGT 3205B	

1N ≅ 0.102kgf



## WRGU Series

An example of the composition of model name & number

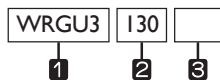

- 1 Model No.
- 2 Length of table
- 3 No symbol – Standard specification / E-Special processing specification

For other sizes and specifications than those in the table of dimensions, please contact us.



Model No.	Main dimensions						Dimensions of the table surface															
	Max. stroke	Width W	Width tolerance	Height M ±0.1	Length L	Mass (kg)	Position of table attachment tap				Side attachment tap position											
							B	n X F	G	S	B <sub>i</sub>	n <sub>i</sub> X F <sub>i</sub>	G <sub>i</sub>	K	b <sub>i</sub>	t <sub>i</sub>	S <sub>i</sub> X I					
WRGU 1025	12				25	0.08		-							1 X 10							
WRGU 1035	18				35	0.11		1 X 10							2 X 10							
WRGU 1045	25				45	0.15		2 X 10							3 X 10							
WRGU 1055	32	30	-0.2	17	55	0.18	18.4	3 X 10	12.5	M2	10			4 X 10	7.5	6.5	12	2.5			M2 X 4	
WRGU 1065	40		-0.4		65	0.21		4 X 10						5 X 10								
WRGU 1075	45				75	0.24		5 X 10						6 X 10								
WRGU 1085	50				85	0.27		6 X 10						7 X 10								
WRGU 2035	18				35	0.2		-						1 X 15								
WRGU 2050	30				50	0.26		1 X 15						2 X 15								
WRGU 2065	40				65	0.34		2 X 15						3 X 15								
WRGU 2080	50	40	-0.2	21	80	0.42	25	3 X 15	17.5	M3	15			4 X 15	10	7.5	16	3.4			M2 X 4	
WRGU 2095	60		-0.4		95	0.5		4 X 15						5 X 15								
WRGU 2110	70				110	0.58		5 X 15						6 X 15								
WRGU 2125	80				125	0.66		6 X 15						7 X 15								
WRGU 3055	30				55	0.57		-						1 X 25								
WRGU 3080	45				80	0.8		1 X 25						2 X 25								
WRGU 3105	60				105	1.03		2 X 25						3 X 25								
WRGU 3130	75	60	±0.1	28	130	1.26	39	3 X 25	27.5	M4	25			4 X 25	15	10	40	5.5			M3 X 6	
WRGU 3155	90				155	1.49		4 X 25						5 X 25								
WRGU 3180	105				180	1.72		5 X 25						6 X 25								
WRGU 3205	130				205	1.95		6 X 25						7 X 25								

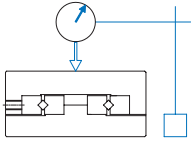
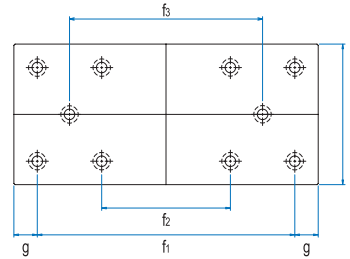
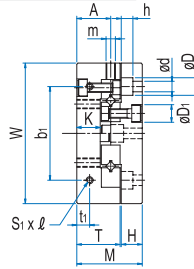
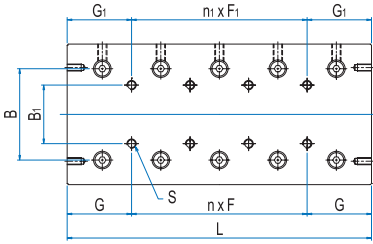

Precision :  $\angle C$

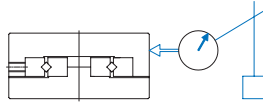

Precision :  $\angle D$

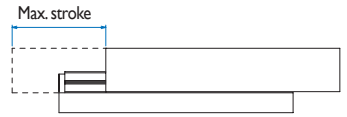

Unit : mm

Dimensions of the side				Dimensions of the base side & position of attachment hole				Basic load rating		Precision mm		Model No.			
T	H	d X D X h	D1	A	m	B2	fi	fz	fs	g	Dynamic C (kN)		Static Co (kN)	$\angle C$	$\angle D$
11	5.5	255 X 41 X 25	4.1	9	M2	22	18	-	-	3.5	0.46	0.61	2	4	WRGU 1025
							28	-	-		0.63	0.92	2	4	WRGU 1035
							38	-	-		0.95	1.53	2	4	WRGU 1045
							48	28	-	1.09	1.84	2	5	WRGU 1055	
							58	38	-	1.23	2.14	2	5	WRGU 1065	
							68	48	-	1.50	2.75	2	5	WRGU 1075	
78	58	-	1.63	3.06	2	5	WRGU 1085								
14	6.5	35 X 6 X 35	6.0	11	M3	30	25	-	-	5	0.84	1.08	2	4	WRGU 2035
							40	-	-		1.17	1.63	2	4	WRGU 2050
							55	-	-		1.46	2.17	2	5	WRGU 2065
							70	40	-	2.01	3.25	2	5	WRGU 2080	
							85	55	-	2.27	3.79	2	5	WRGU 2095	
							100	70	-	2.52	4.34	3	6	WRGU 2110	
115	85	-	2.76	4.88	4	6	WRGU 2125								
18.5	9	45 X 75 X 5	7.5	14.5	M4	40	35	-	-	10	2.71	3.67	2	5	WRGU 3055
							60	-	-		4.06	6.11	2	5	WRGU 3080
							85	-	-		4.68	7.33	3	6	WRGU 3105
							110	-	-	5.86	9.78	3	6	WRGU 3130	
							135	-	85	6.98	12.2	3	6	WRGU 3155	
							160	-	110	8.05	14.7	3	7	WRGU 3180	
185	85	135	8.57	15.9	3	7	WRGU 3205								

1N  $\cong$  0.102kgf

## WRGU Series

An example of the composition of model name & number

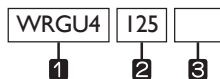

- 1 Model No.
- 2 Length of table
- 3 No symbol – Standard specification / E-Special processing specification

For other sizes and specifications than those in the table of dimensions, please contact us.



Model No.	Main dimensions					Dimensions of the table surface																						
	Max. stroke	Width W	Height M ±0.1	Length L	Mass (kg)	Position of table attachment tap				Side attachment tap position																		
						B	n X F	G	S	B <sub>1</sub>	n <sub>1</sub> X F <sub>1</sub>	G <sub>1</sub>	G <sub>2</sub>	b <sub>1</sub>	b <sub>2</sub>	t <sub>1</sub>	t <sub>2</sub>	S <sub>1</sub> X I										
WRGU 4085	50			85	1.5		-								1X40		10.5											
WRGU 4125	75			125	2.3		1X40								2X40		18.0											
WRGU 4165	105	80	35	165	3.1		2X40	42.5	M5	40				3X40		23.0												
WRGU 4205	135			205	3.8		3X40							4X40		30.5												
WRGU 4245	155			245	4.6		4X40							5X40		38												
WRGU 4285	185			285	5.3		5X40							6X40		43.0												
WRGU 6110	60			110	3.2		-							1X50		16.0												
WRGU 6160	95			160	4.6		1X50							2X50		23.5												
WRGU 6210	130			210	6.0		2X50							3X50		31.0												
WRGU 6260	165	100	45	260	7.4	63	3X50	55	M6	50				4X50	30.0	38.5	60	92	8	15						M4X8		
WRGU 6310	200			310	8.7		4X50							5X50		46.0												
WRGU 6360	235			360	10.1		5X50							6X50		53.5												
WRGU 6410	265			410	11.5		6X50							7X50		63.5												
WRGU 9210	130			210	12.0		-									27.0												
WRGU 9310	180			310	17.6		1X100								1X100		52.0											
WRGU 9410	350			410	23.2		2X100								2X100		17.0											
WRGU 9510	450			510	28.8		3X100								3X100		17.0											
WRGU 9610	550	145	60	610	34.4	96	4X100	105	M8	85				4X100	55.0	17.0	90	135	11	20						M4X8		
WRGU 9710	650			710	40.0		5X100							5X100		17.0												
WRGU 9810	750			810	45.6		6X100							6X100/7X100		17.0												
WRGU 9910	850			910	51.2		7X100							8X100		17.0												
WRGU 91010	950			1010	56.8		8X100							9X100		17.0												

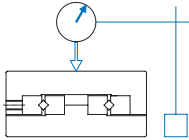
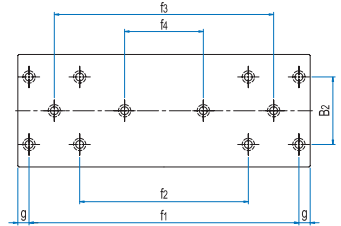
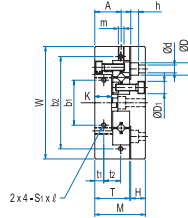
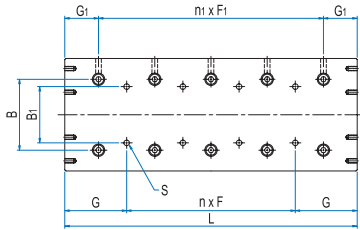

Precision :  $\Delta C$

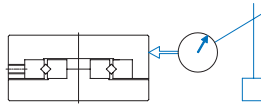

Precision :  $\Delta D$

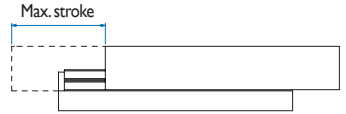

Unit : mm

Dimensions of the side							Dimensions of the base side & position of attachment hole					Basic load rating		Precision mm		Model No.
T	H	d X D X h	D1	m1	m2	B2	f1	f2	f3	f4	g	Dynamic C (kN)	Static Co (kN)	$\Delta C$	$\Delta D$	
24	10.5	55 X 9.5 X 6	9.5	M4	M4	60	65	-	-	-	10	5.92	8.10	2	5	WRGU 4085
							80	-	-	-	22.5	8.85	13.5	2	6	WRGU 4125
							120	-	-	-	22.5	11.5	18.9	2	7	WRGU 4165
							160	80	-	-	22.5	14.0	24.3	2	7	WRGU 4205
							200	120	-	-	22.5	16.4	29.7	2	7	WRGU 4245
							240	160	-	-	22.5	18.7	35.1	2	7	WRGU 4285
31	13	7 X 11 X 7	11	M5	M5	60	90	-	-	-	10	16.4	22.7	2	6	WRGU 6110
							140	-	-	-	10	20.5	30.2	2	6	WRGU 6160
							190	-	90	-	10	28.2	45.4	2	7	WRGU 6210
							240	-	140	-	10	35.4	60.5	2	7	WRGU 6260
							290	-	190	-	10	38.8	68.0	2	8	WRGU 6310
							340	140	240	-	10	45.4	83.2	3	8	WRGU 6360
43	16	9 X 14 X 9	14	M8	M6	90	100	-	-	-	55	52.3	75.8	3	7	WRGU 9210
							200	-	-	-	55	81.1	133	3	7	WRGU 9310
							300	-	100	-	55	81.1	133	4	8	WRGU 9410
							400	-	200	-	55	98.7	171	4	8	WRGU 9510
							500	100	300	-	55	115	209	4	9	WRGU 9610
							600	200	400	-	55	131	246	4	9	WRGU 9710
							700	300	500	100	55	139	265	5	10	WRGU 9810
							800	400	600	200	55	155	303	5	10	WRGU 9910
							900	500	700	300	55	169	341	5	10	WRGU 91010

1N  $\approx$  0.102kgf

## WRG-AC Type

An example of the composition of model name & number

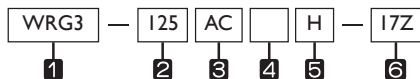

- 1** Model No.
- 2** Length of race rail
- 3** AC-Cage Anti-creep type
- 4** No symbol –Standard race rail / E-Special specification of race rail
- 5** Symbol of precision: No symbol –Normal / H-Precision / P-Super precision
- 6** Number of rollers

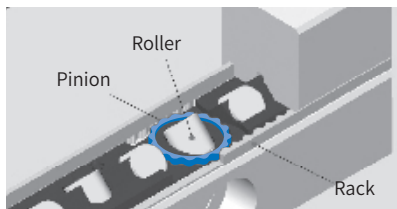

Model No.	Max. stroke	D	No. of rollers Z	Main dimensions					
				L	A	B	C	M x P	N
WRG 2030 AC	18	2	4	30	12	6	54	1 X 15	75
WRG 2045 AC	24		7	45				2 X 15	
WRG 2060 AC	30		10	60				3 X 15	
WRG 2075 AC	44		12	75				4 X 15	
WRG 2090 AC	50		15	90				5 X 15	
WRG 2105 AC	64		17	105				6 X 15	
WRG 2120 AC	70		20	120				7 X 15	
WRG 2135 AC	84		22	135				8 X 15	
WRG 2150 AC	90		25	150				9 X 15	
WRG 2165 AC	96		28	165				10 X 15	
WRG 2180 AC	102	31	180	11 X 15					
WRG3050AC2	24	4	6	50	18	8	86	1x25	125
WRG3075AC2	54		8	75				2x25	
WRG3100AC2	66		12	100				3x25	
WRG3125AC2	78		16	125				4x25	
WRG3150AC2	90		20	150				5x25	
WRG3175AC2	100		24	175				6x25	
WRG3200AC2	112		28	200				7x25	
WRG3225AC2	144		30	225				8x25	
WRG 4080 AC	58	4	7	80	22	11	102	1 X 40	20
WRG 4120 AC	82		11	120				2 X 40	
WRG 4160 AC	106		15	160				3 X 40	
WRG 4200 AC	130		19	200				4 X 40	
WRG 4240 AC	154		23	240				5 X 40	
WRG 4280 AC	178		27	280				6 X 40	
WRG 4320 AC	202		31	320				7 X 40	
WRG 4360 AC	226		35	360				8 X 40	
WRG 4400 AC	250		39	400				9 X 40	
WRG 4440 AC	274		43	440				10 X 40	
WRG 4480 AC	298	47	480	11 X 40					

- Note (1) 1 SET (Race rail: 4EA, Roller cage: 2EA, Stopper: 8EA)  
 (2) Basic load rating is based on 1 set.  
 (3) If a stopper is needed, please make separate description.  
 (4) For the vertical use of the device, please contact us.

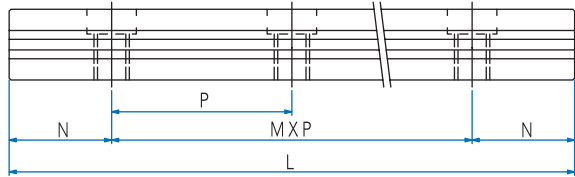
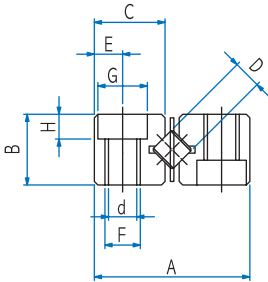

Unit : mm

Dimensions					Basic load rating		Mass (ISET) g	Model No.
E	F	d	G	H	Dynamic C (kN)	Static Co (kN)		
25	M3	2.55	44	2	0.62	0.73	28	WRG 2030 AC
					0.86	1.10	43	WRG 2045 AC
					1.28	1.83	57	WRG 2060 AC
					1.48	2.20	71	WRG 2075 AC
					1.67	2.56	85	WRG 2090 AC
					1.85	2.93	98	WRG 2105 AC
					2.2	3.66	112	WRG 2120 AC
					2.37	4.03	126	WRG 2135 AC
					2.54	4.39	140	WRG 2150 AC
					2.86	5.13	153	WRG 2165 AC
					3.02	5.49	166	WRG 2180 AC
35	M4	3.30	6	3.1	6.53	9.37	99	WRG3050AC2
					8.20	12.50	144	WRG3075AC2
					11.27	18.75	190	WRG3100AC2
					14.12	25.00	236	WRG3125AC2
					16.81	31.25	281	WRG3150AC2
					19.38	37.50	327	WRG3175AC2
					21.86	43.75	373	WRG3200AC2
					23.06	46.88	418	WRG3225AC2
45	M5	4.3	8	4.2	5.92	8.10	260	WRG 4080 AC
					8.85	13.5	400	WRG 4120 AC
					11.5	18.9	530	WRG 4160 AC
					14.0	24.3	660	WRG 4200 AC
					16.4	29.7	790	WRG 4240 AC
					18.7	35.1	920	WRG 4280 AC
					20.88	40.5	1050	WRG 4320 AC
					23.0	45.9	1180	WRG 4360 AC
					25.1	51.3	1300	WRG 4400 AC
					27.1	56.7	1430	WRG 4440 AC
					29.1	62.1	1530	WRG 4480 AC

1N ≅ 0.102kgf

## WRGW Type

An example of the composition of model name & number

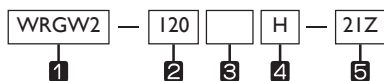

- 1** Model No.
- 2** Length of race rail
- 3** No symbol – Standard race rail / E-Special specification of race rail
- 4** Symbol of precision: No symbol –Normal / H-Precision / P-Super precision
- 5** Number of rollers



Model No.	Max. stroke	D	No. of rollers Z	Main dimensions						
				L	A	t	B <sub>1</sub>	B <sub>2</sub>	C	P <sub>1</sub>
WRGW 1020	12	1.5	5	20	4.5	0.5	17	7.6	3.8	13.4
WRGW 1030	22		7	30						
WRGW 1040	27		10	40						
WRGW 1050	32		13	50						
WRGW 1060	37		16	60						
WRGW 1070	42		19	70						
WRGW 1080	52	21	80							
WRGW 2030	18	2	5	30	6.5	0.5	24	11	5.5	19
WRGW 2045	24		8	45						
WRGW 2060	30		11	60						
WRGW 2075	44		13	75						
WRGW 2090	50		16	90						
WRGW 2105	64		18	105						
WRGW 2120	70	21	120							
WRGW 3050	28	3	7	50	8.5	0.5	36	16.6	8.3	29
WRGW 3075	48		10	75						
WRGW 3100	58		14	100						
WRGW 3125	78		17	125						
WRGW 3150	88		21	150						
WRGW 3175	108		24	175						
WRGW 3200	118	28	200							
WRGW 4080	58	4	7	80	11.5	0.5	44	20.4	10.2	35
WRGW 4120	82		11	120						
WRGW 4160	106		15	160						
WRGW 4200	130		19	200						
WRGW 4240	154		23	240						
WRGW 4280	178		27	280						

Note (1) 1 SET (Race rail: 4EA, Roller cage: 2EA, Stopper: 8EA)

(2) Basic load rating is based on 1 set.

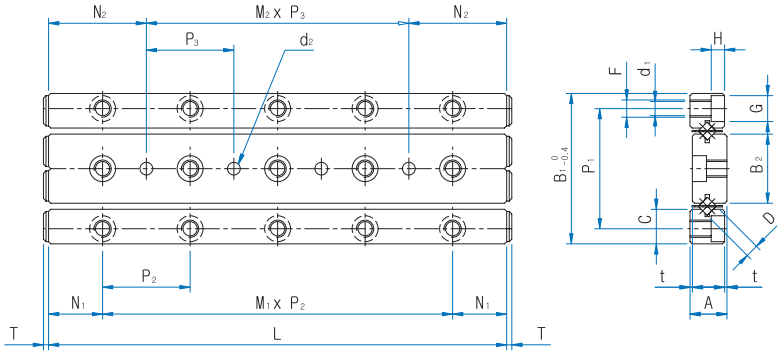

Unit : mm

Dimensions										Basic load rating		Mass (ISET)	Model No.
M1 X P2	N1	M2 X P3	N2	F	d1	G	H	T	d2	Dy- namic C (kN)	Static Co (kN)	g	
1 X 10		-								0.46	0.61	9	WRGW 1020
2 X 10		1 X 10								0.63	0.92	14	WRGW 1030
3 X 10		2 X 10								0.95	1.53	18	WRGW 1040
4 X 10	5	3 X 10	10	M2	1.65	3	1.4	1.5	2	1.09	1.84	22	WRGW 1050
5 X 10		4 X 10								1.37	2.45	26	WRGW 1060
6 X 10		5 X 10								1.50	2.75	31	WRGW 1070
7 X 10		6 X 10								1.63	3.06	35	WRGW 1080
1 X 15		-								0.84	1.08	29	WRGW 2030
2 X 15		1 X 15								1.46	2.17	43	WRGW 2045
3 X 15		2 X 15								1.74	2.71	58	WRGW 2060
4 X 15	7.5	3 X 15	15	M3	2.55	4.4	2	2	3	2.01	3.25	72	WRGW 2075
5 X 15		4 X 15								2.52	4.34	83	WRGW 2090
6 X 15		5 X 15								2.76	4.38	99	WRGW 2105
7 X 15		6 X 15								3.00	5.42	113	WRGW 2120
1 X 25		-								2.71	3.67	101	WRGW 3050
2 X 25		1 X 25								4.06	6.11	142	WRGW 3075
3 X 25		2 X 25								5.28	8.55	197	WRGW 3100
4 X 25	12.5	3 X 25	25	M4	3.3	6	3.1	2.5	4	5.86	9.78	240	WRGW 3125
5 X 25		4 X 25								6.98	12.2	292	WRGW 3150
6 X 25		5 X 25								8.06	14.7	339	WRGW 3175
7 X 25		6 X 25								9.08	17.1	387	WRGW 3200
1 X 40		-								5.92	8.10	263	WRGW 4080
2 X 40		1 X 40								8.85	13.5	401	WRGW 4120
3 X 40		2 X 40								11.5	18.9	530	WRGW 4160
4 X 40	20	3 X 40	40	M5	4.3	8	4.2	2.5	5	14.0	24.3	660	WRGW 4200
5 X 40		4 X 40								16.4	29.7	787	WRGW 4240
6 X 40		5 X 40								18.7	35.1	920	WRGW 4280

1N ≅ 0.102kgf



## WRGT Series

An example of the composition of model number

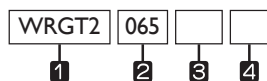

- 1** Model No.
- 2** Length of table
- 3** No symbol – Base tap type
- 4** No symbol- Standard specification / E-Special processing specification



For other sizes and specifications than those in the table of dimensions, please contact us.

Model No.	Main dimensions				Dimensions of the table surface										
	Max. stroke	Width W ±0.1	Height M ±0.1	Length L	Position of table attachment tap						F <sub>1</sub>	n <sub>1</sub> X F <sub>1</sub>	D <sub>1</sub>	B <sub>1</sub>	G <sub>1</sub>
					B	F	n X F	G	S						
WRGT 1025	12			25		18	1 X 18	3.5			1 X 10				
WRGT 1035	18			35		28	1 X 28	3.5			2 X 10				
WRGT 1045	25			45		20	1 X 20	12.5			3 X 10				
WRGT 1055	32	20	8	55	14	30	1 X 30	12.5	M2.6	10	4 X 10	4.1	12.4	7.5	
WRGT 1065	40			65		20	2 X 20	12.5			5 X 10				
WRGT 1075	45			75		30	1 X 30	22.5			6 X 10				
WRGT 1085	50			85		30	2 X 30	12.5			7 X 10				
WRGT 2035	18			35		28	1 X 28	3.5			1 X 15				
WRGT 2050	30			50		43	1 X 43	3.5			2 X 15				
WRGT 2065	40			65		30	1 X 30	17.5			3 X 15				
WRGT 2080	50	30	12	80	22	45	1 X 45	17.5	M3	15	4 X 15	6	20	10	
WRGT 2095	60			95		30	2 X 30	17.5			5 X 15				
WRGT 2110	70			110		45	1 X 45	32.5			6 X 15				
WRGT 2125	80			125		45	2 X 45	17.5			7 X 15				
WRGT 3055	30			55		40	1 X 40	7.5			1 X 25				
WRGT 3080	45			80		65	1 X 65	7.5			2 X 25				
WRGT 3105	60			105		50	1 X 50	27.5			3 X 25				
WRGT 3130	75	40	16	130	30	75	1 X 75	27.5	M4	25	4 X 25	7.5	28.4	15	
WRGT 3155	90			155		50	2 X 50	27.5			5 X 25				
WRGT 3180	105			180		75	1 X 75	52.5			6 X 25				
WRGT 3205	130			205		75	2 X 75	27.5			7 X 25				

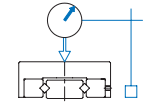
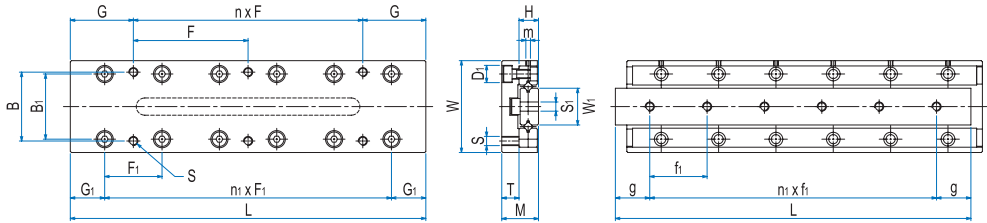

Precision :  $\Delta/C$

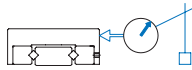

Precision :  $\Delta/D$

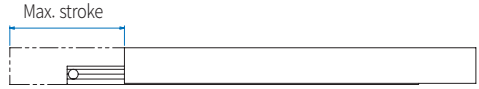

Unit : mm

Dimensions of the side				Dimensions of the base side position of attachment hole				Basic load rating		Precision		Model No.
T	H	W <sub>1</sub>	m	S <sub>1</sub>	f <sub>1</sub>	m <sub>2</sub> x f <sub>1</sub>	g	Dynamic C (kN)	Static C <sub>0</sub> (kN)	$\Delta$ C	$\Delta$ D	
7.5	4	6.6	M2	M2.6	7.5	2 x 7.5	5	0.46	0.61	2	4	WRGT 1025
					10.0	2 x 10	7.5	0.63	0.92	2	4	WRGT 1035
					10.0	3 x 10	7.5	0.95	1.53	2	5	WRGT 1045
					10.0	4 x 10	7.5	1.09	1.84	2	5	WRGT 1055
					10.0	5 x 10	7.5	1.23	2.14	2	5	WRGT 1065
					10.0	6 x 10	7.5	1.50	2.75	2	5	WRGT 1075
					10.0	7 x 10	7.5	1.63	3.06	2	5	WRGT 1085
11.5	6	12.0	M2	M3	20.0	1 x 20	7.5	0.84	1.08	2	4	WRGT 2035
					15.0	2 x 15	10	1.17	1.63	2	4	WRGT 2050
					15.0	3 x 15	10	1.46	2.17	2	5	WRGT 2065
					15.0	4 x 15	10	2.01	3.25	2	5	WRGT 2080
					15.0	5 x 15	10	2.27	3.79	2	5	WRGT 2095
					15.0	6 x 15	10	2.52	4.34	2	5	WRGT 2110
15.5	8	16.0	M2	M4	35.0	1 x 35	10	2.71	3.67	2	5	WRGT 3055
					25.0	2 x 25	15	4.06	6.11	2	5	WRGT 3080
					25.0	3 x 25	15	4.68	7.33	3	6	WRGT 3105
					25.0	4 x 25	15	5.86	9.78	3	6	WRGT 3130
					25.0	5 x 25	15	6.98	12.2	3	6	WRGT 3155
					25.0	6 x 25	15	8.05	14.7	3	6	WRGT 3180
					25.0	7 x 25	15	8.57	15.9	3	6	WRGT 3205

1N  $\approx$  0.102kgf

## WRGT-B Series

An example of the composition of model number

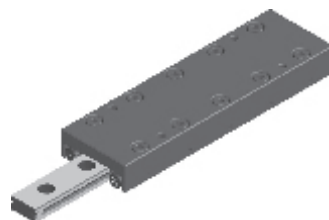
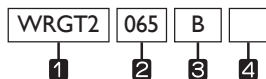

- 1 Model No.
- 2 Length of table
- 3 B-Base hole type
- 4 No symbol-Standard specification / E-Special processing specification

※ For other sizes and specifications than those in the table of dimensions, please contact us.

Model No.	Main dimensions				Dimensions of the table surface										
	Max. stroke	Width W ±0.1	Height M ±0.1	Length L	Position of table attachment tap					Fi	niXF <sub>i</sub>	Di	Bi	Gi	
					B	F	n X F	G	S						
WRGT 1025B	12			25		18	1 X 18	3.5			1 X 10				
WRGT 1035B	18			35		28	1 X 28	3.5			2 X 10				
WRGT 1045B	25			45		20	1 X 20	12.5			3 X 10				
WRGT 1055B	32	20	8	55	14	30	1 X 30	12.5	M2.6	10	4 X 10	4.1	12.4	7.5	
WRGT 1065B	40			65		20	2 X 20	12.5			5 X 10				
WRGT 1075B	45			75		30	1 X 30	22.5			6 X 10				
WRGT 1085B	50			85		30	2 X 30	12.5			7 X 10				
WRGT 2035B	18			35		28	1 X 28	3.5			1 X 15				
WRGT 2050B	30			50		43	1 X 43	3.5			2 X 15				
WRGT 2065B	40			65		30	1 X 30	17.5			3 X 15				
WRGT 2080B	50	30	12	80	22	45	1 X 45	17.5	M3	15	4 X 15	6	20	10	
WRGT 2095B	60			95		30	2 X 30	17.5			5 X 15				
WRGT 2110B	70			110		45	1 X 45	32.5			6 X 15				
WRGT 2125B	80			125		45	2 X 45	17.5			7 X 15				
WRGT 3055B	30			55		40	1 X 40	7.5			1 X 25				
WRGT 3080B	45			80		65	1 X 65	7.5			2 X 25				
WRGT 3105B	60			105		50	1 X 50	27.5			3 X 25				
WRGT 3130B	75	40	16	130	30	75	1 X 75	27.5	M4	25	4 X 25	7.5	28.4	15	
WRGT 3155B	90			155		50	2 X 50	27.5			5 X 25				
WRGT 3180B	105			180		75	1 X 75	52.5			6 X 25				
WRGT 3205B	130			205		75	2 X 75	27.5			7 X 25				

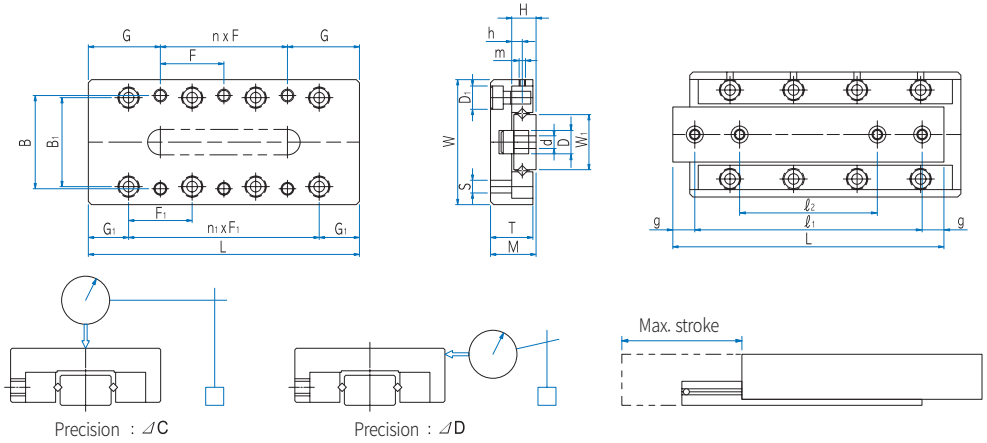

Unit: □

Dimensions of the side				Dimensions of the base side position of attachment hole				Basic load rating			Precision		Model No.
T	H	W <sub>1</sub>	m	d x D x h	l <sub>1</sub>	l <sub>2</sub>	g	Dynamic C (kN)	Static Co (kN)	$\Delta C$	$\Delta D$		
7.5	4	6.6	M2	25 X 41 X 22	18	-	3.5	0.46	0.61	2	4	WRGT 1025B	
					25	-	5.0	0.63	0.92	2	4	WRGT 1035B	
					38	25	3.5	0.95	1.53	2	5	WRGT 1045B	
					48	29	3.5	1.09	1.84	2	5	WRGT 1055B	
					55	31	5.0	1.23	2.14	2	5	WRGT 1065B	
					65	35	5.0	1.50	2.75	2	5	WRGT 1075B	
					75	40	5.0	1.63	3.06	2	5	WRGT 1085B	
11.5	6	12.0	M2	35 X 6 X 32	25	-	5.0	0.84	1.08	2	4	WRGT 2035B	
					35	-	7.5	1.17	1.63	2	4	WRGT 2050B	
					55	33	5.0	1.46	2.17	2	5	WRGT 2065B	
					70	40	5.0	2.01	3.25	2	5	WRGT 2080B	
					85	45	5.0	2.27	3.79	2	5	WRGT 2095B	
					95	50	7.5	2.52	4.34	2	5	WRGT 2110B	
					110	55	7.5	2.76	4.88	2	5	WRGT 2125B	
15.5	8	16.0	M2	45 X 75 X 42	40	-	7.5	2.71	3.67	2	5	WRGT 3055B	
					68	43	6.0	4.06	6.11	2	5	WRGT 3080B	
					90	55	7.5	4.68	7.33	3	6	WRGT 3105B	
					115	65	7.5	5.86	9.78	3	6	WRGT 3130B	
					140	95	7.5	6.98	12.2	3	6	WRGT 3155B	
					165	85	7.5	8.05	14.7	3	6	WRGT 3180B	
					190	90	7.5	8.57	15.9	3	6	WRGT 3205B	

1N  $\approx$  0.102kgf

## WRGU Series

An example of the composition of model name & number

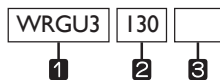

- 1** Model No.
- 2** Length of table
- 3** No symbol – Standard specification / E-Special processing specification

For other sizes and specifications than those in the table of dimensions, please contact us.



Model No.	Main dimensions						Dimensions of the table surface														
	Max. stroke	Width W	Width tolerance	Height M ±0.1	Length L	Mass (kg)	Position of table attachment tap				Side attachment tap position										
							B	n X F	G	S	B <sub>i</sub>	n <sub>i</sub> X F <sub>i</sub>	G <sub>i</sub>	K	b <sub>i</sub>	t <sub>i</sub>	S <sub>i</sub> X I <sub>i</sub>				
WRGU 1025	12				25	0.08		-					1 X 10								
WRGU 1035	18				35	0.11		1 X 10					2 X 10								
WRGU 1045	25				45	0.15		2 X 10					3 X 10								
WRGU 1055	32	30	-0.2	17	55	0.18	184	3 X 10	12.5	M2	10	4 X 10	7.5	6.5	12	2.5				M2 X 4	
WRGU 1065	40		-0.4		65	0.21		4 X 10				5 X 10									
WRGU 1075	45				75	0.24		5 X 10				6 X 10									
WRGU 1085	50				85	0.27		6 X 10				7 X 10									
WRGU 2035	18				35	0.2		-				1 X 15									
WRGU 2050	30				50	0.26		1 X 15				2 X 15									
WRGU 2065	40				65	0.34		2 X 15				3 X 15									
WRGU 2080	50	40	-0.2	21	80	0.42	25	3 X 15	17.5	M3	15	4 X 15	10	7.5	16	3.4				M2 X 4	
WRGU 2095	60		-0.4		95	0.5		4 X 15				5 X 15									
WRGU 2110	70				110	0.58		5 X 15				6 X 15									
WRGU 2125	80				125	0.66		6 X 15				7 X 15									
WRGU 3055	30				55	0.57		-				1 X 25									
WRGU 3080	45				80	0.8		1 X 25				2 X 25									
WRGU 3105	60				105	1.03		2 X 25				3 X 25									
WRGU 3130	75	60	±0.1	28	130	1.26	39	3 X 25	27.5	M4	25	4 X 25	15	10	40	5.5				M3 X 6	
WRGU 3155	90				155	1.49		4 X 25				5 X 25									
WRGU 3180	105				180	1.72		5 X 25				6 X 25									
WRGU 3205	130				205	1.95		6 X 25				7 X 25									

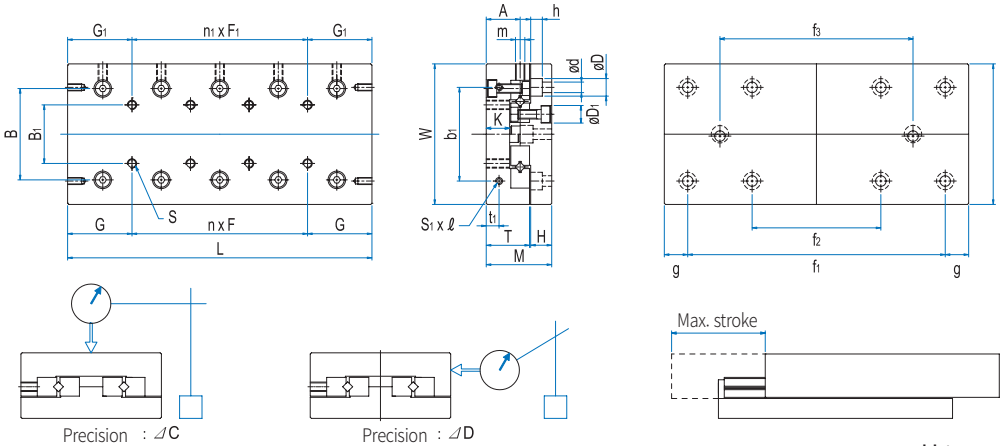

Unit: mm

Dimensions of the side				Dimensions of the base side & position of attachment hole				Basic load rating		Precision mm		Model No.			
T	H	d X D X h	Di	A	m	Bz	fi	fz	fs	g	Dynamic C (kN)		Static Co (kN)	ΔC	ΔD
11	5.5	255 X 4.1 X 25	4.1	9	M2	22	18	-	-	3.5	0.46	0.61	2	4	WRGU 1025
							28	-	-		0.63	0.92	2	4	WRGU 1035
							38	-	-		0.95	1.53	2	4	WRGU 1045
							48	28	-		1.09	1.84	2	5	WRGU 1055
							58	38	-		1.23	2.14	2	5	WRGU 1065
							68	48	-		1.50	2.75	2	5	WRGU 1075
							78	58	-		1.63	3.06	2	5	WRGU 1085
14	6.5	35 X 6 X 35	6.0	11	M3	30	25	-	-	5	0.84	1.08	2	4	WRGU 2035
							40	-	-		1.17	1.63	2	4	WRGU 2050
							55	-	-		1.46	2.17	2	5	WRGU 2065
							70	40	-		2.01	3.25	2	5	WRGU 2080
							85	55	-		2.27	3.79	2	5	WRGU 2095
							100	70	-		2.52	4.34	3	6	WRGU 2110
18.5	9	45 X 7.5 X 5	7.5	14.5	M4	40	35	-	-	10	2.71	3.67	2	5	WRGU 3055
							60	-	-		4.06	6.11	2	5	WRGU 3080
							85	-	-		4.68	7.33	3	6	WRGU 3105
							110	-	-		5.86	9.78	3	6	WRGU 3130
							135	-	85		6.98	12.2	3	6	WRGU 3155
							160	-	110		8.05	14.7	3	7	WRGU 3180
185	85	135	8.57	15.9	3	7	WRGU 3205								

1N ≅ 0.102kgf

## WRGU Series

An example of the composition of model name & number

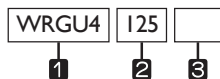

- 1** Model No.
- 2** Length of table
- 3** No symbol – Standard specification / E-Special processing specification

For other sizes and specifications than those in the table of dimensions, please contact us.



Model No.	Main dimensions					Dimensions of the table surface																		
	Max. stroke	Width W	Height M ±0.1	Length L	Mass (kg)	Position of table attachment tap				Side attachment tap position														
						B	nXF	G	S	B1	nXF1	G1	G2	b1	b2	t1	t2	S1X1						
WRGU 4085	50			85	1.5		-						1X40		10.5									
WRGU 4125	75			125	2.3		1X40						2X40		18.0									
WRGU 4165	105	80	35	165	3.1		2X40						3X40		23.0									
WRGU 4205	135			205	3.8	53	3X40	42.5	M5	40			4X40	22.5	30.5	55	-	6.5	-				MX6	
WRGU 4245	155			245	4.6		4X40						5X40		38									
WRGU 4285	185			285	5.3		5X40						6X40		43.0									
WRGU 6110	60			110	3.2		-						1X50		16.0									
WRGU 6160	95			160	4.6		1X50						2X50		23.5									
WRGU 6210	130			210	6.0		2X50						3X50		31.0									
WRGU 6260	165	100	45	260	7.4	63	3X50	55	M6	50			4X50	30.0	38.5	60	92	8	15				M4X8	
WRGU 6310	200			310	8.7		4X50						5X50		46.0									
WRGU 6360	235			360	10.1		5X50						6X50		53.5									
WRGU 6410	265			410	11.5		6X50						7X50		63.5									
WRGU 9210	130			210	12.0		-						1X100		27.0									
WRGU 9310	180			310	17.6		1X100						2X100		52.0									
WRGU 9410	350			410	23.2		2X100						3X100		17.0									
WRGU 9510	450			510	28.8		3X100						4X100		17.0									
WRGU 9610	550	145	60	610	34.4	96	4X100	105	M8	85			5X100	55.0	17.0	90	135	11	20				M4X8	
WRGU 9710	650			710	40.0		5X100						6X100		17.0									
WRGU 9810	750			810	45.6		6X100						X100		17.0									
WRGU 9910	850			910	51.2		7X100						8X100		17.0									
WRGU 91010	950			1010	56.8		8X100						9X100		17.0									

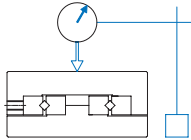
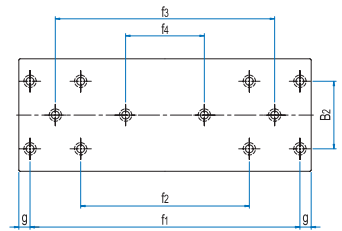
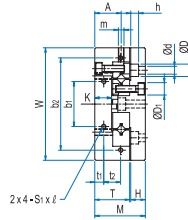
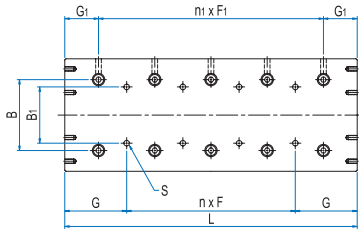

Precision :  $\Delta C$

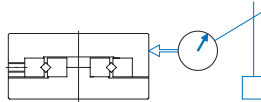

Precision :  $\Delta D$

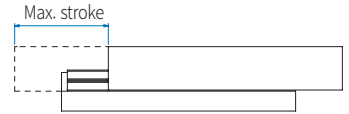

Unit : mm

Dimensions of the side							Dimensions of the base side & position of attachment hole					Basic load rating		Precision mm		Model No.
T	H	d X D X h	D1	m1	m2	B2	f1	f2	f3	f4	g	Dynamic C (kN)	Static Co (kN)	$\Delta C$	$\Delta D$	
24	10.5	55 X 95 X 6	9.5	M4	M4	60	65	-	-	-	10	5.92	8.10	2	5	WRGU 4085
							80	-	-	-	22.5	8.85	13.5	2	6	WRGU 4125
							120	-	-	-	22.5	11.5	18.9	2	7	WRGU 4165
							160	80	-	-	22.5	14.0	24.3	2	7	WRGU 4205
							200	120	-	-	22.5	16.4	29.7	2	7	WRGU 4245
							240	160	-	-	22.5	18.7	35.1	2	7	WRGU 4285
31	13	7 X 11 X 7	11	M5	M5	60	90	-	-	-	10	16.4	22.7	2	6	WRGU 6110
							140	-	-	-	10	20.5	30.2	2	6	WRGU 6160
							190	-	90	-	10	28.2	45.4	2	7	WRGU 6210
							240	-	140	-	10	35.4	60.5	2	7	WRGU 6260
							290	-	190	-	10	38.8	68.0	2	8	WRGU 6310
							340	140	240	-	10	45.4	83.2	3	8	WRGU 6360
43	16	9 X 14 X 9	14	M8	M6	90	100	-	-	-	55	52.3	75.8	3	7	WRGU 9210
							200	-	-	-	55	81.1	133	3	7	WRGU 9310
							300	-	100	-	55	81.1	133	4	8	WRGU 9410
							400	-	200	-	55	98.7	171	4	8	WRGU 9510
							500	100	300	-	55	115	209	4	9	WRGU 9610
							600	200	400	-	55	131	246	4	9	WRGU 9710
							700	300	500	100	55	139	265	5	10	WRGU 9810
							800	400	600	200	55	155	303	5	10	WRGU 9910
							900	500	700	300	55	169	341	5	10	WRGU 91010

1N  $\cong$  0.102kgf





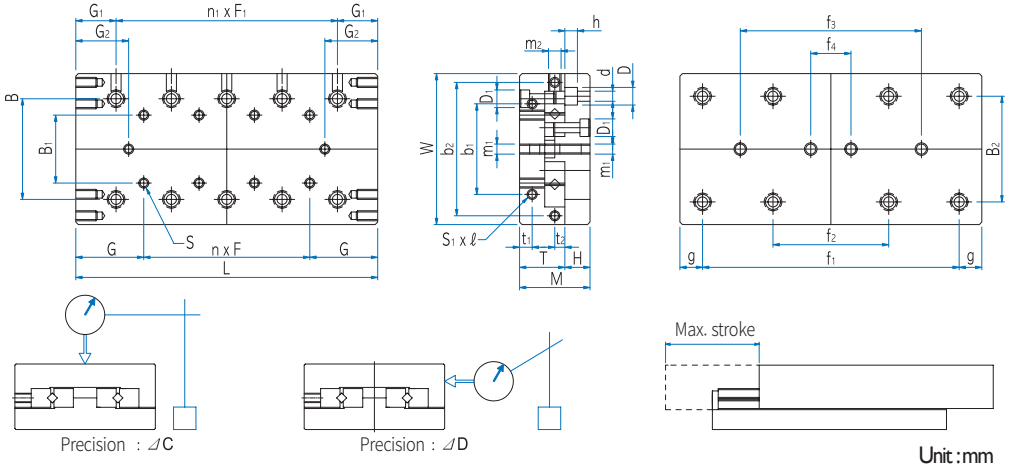

Dimensions of the side				Dimensions of the base side & position of attachment hole				Basic load rating		Precision mm		Model No.			
T	H	d X D X h	D1	m1	m2	B2	f1	f2	f3	g	Dynamic C (kN)		Static Co (kN)	ΔC	ΔD
14	6.4	35 X 6 X 3.5	6.0	M3	M3	30	25	-	-	-	0.62	0.73	2	4	WRGU 2035 AC
							40	-	-	-	0.86	1.10	2	4	WRGU 2050 AC
							55	-	-	-	1.07	1.46	2	5	WRGU 2065 AC
							70	40	-	5	1.28	1.83	2	5	WRGU 2080 AC
							85	55	-	1.48	2.20	2	5	WRGU 2095 AC	
							100	70	-	1.85	2.93	3	6	WRGU 2110 AC	
18.5	9	45 X 7.5 X 5	7.5	M4	M4	40	35	-	-	-	2.71	3.67	2	5	WRGU 3055 AC
							60	-	-	-	4.06	6.11	2	5	WRGU 3080 AC
							85	-	90	-	4.68	7.33	3	6	WRGU 3105 AC
							110	-	140	10	5.86	9.78	3	6	WRGU 3130 AC
							135	-	190	6.98	12.2	3	6	WRGU 3155 AC	
							160	-	240	8.05	14.7	3	7	WRGU 3180 AC	
24	10.5	55 X 9.5 X 6	9.5	M4	M4	60	185	85	290	-	8.57	15.9	3	7	WRGU 3205 AC
							65	-	-	10	5.92	8.10	2	5	WRGU 4085 AC
							80	-	-	22.5	8.85	13.5	3	6	WRGU 4125 AC
							120	-	-	22.5	11.5	18.9	3	7	WRGU 4165 AC
							160	80	-	22.5	14.0	24.3	3	7	WRGU 4205 AC
							200	120	-	22.5	16.4	29.7	3	7	WRGU 4245 AC
240	160	-	22.5	18.7	35.1	3	7	WRGU 4285 AC							

1N ≅ 0.102kgf

