

E/149000/* Electromechanical rodless ball screw actuator with or without servo motor



- > □48 ... 100 mm
- > Robust construction
- > High performance internal guiding
- > Reliable performance
- > Long life
- > Servo motors
- > Different feedback systems available
- > Holding brake available
- > Drives available with EtherCAT, PROFINET, PROFIBUS, EtherNet/IP, DeviceNet & CANopen communications



Technical features

Function:

Actuator with ball screw; with or without servo motor

Actuator size □:

48, 60, 80, 100 mm

Strokes:

Available 100 ... 4100 mm (short strokes < 100 mm and > 2500 mm on request)

Speed:

max. 1,6 m/s (see graph page 9)

Forces F_{max} :

10150 N (thrust force)

Motor data

Voltage:

400 VAC

Rated current:

0,7 ... 9 A

Power:

0,16 ... 2,2 kW

Drive data

Voltage:

400 VAC

Rated current:

3,0 ... 10,5 A

Output power:

0,75 ... 4,0 kW

Duty cycle:

100 %

Temperature:

Operating temperature actuator only:

-20 ... 80 °C (-4 ... 176 °F)

Ambient temperature:

Actuator: -20 ... 80 °C (-4 ... 176 °F)

Motor: 0 ... 40 °C (32 ... 104 °F)

IP Protection rate motor only:

IP65

Standard Materials:

End covers: Anodized aluminum

Yoke, carriage, cover and barrel: Anodized aluminum

Cover strip: PU

Technical data

Actuator size □ (mm)	48		60			80			100		
Spindle diameter (mm)	12		16			20			25		
Spindle pitch (mm)	5	10	5	10	16	5	10	20	5	10	25
Axial clearance Actuator (mm)	+ 0,02		+ 0,04			+ 0,04			+ 0,04		
Dynamic force C (N)	5500	5100	10100	7900		13100	9700	6800	14600	14500	7400
F max axial (N)	3000	2520	5200	4100	4200	8000	5500	3800	10150	10100	4750
Momentum torque max (Drive shaft) (Nm)	2,4	4,0	4,2	6,5	10,8	6,4	8,8	12,2	8,1	16,1	19,0
Order stroke (mm)*	100 ... 1280		100 ... 2500			100 ... 2500			100 ... 2500**		
Available velocity with standard Norgren servo motor (m/s)	0,25	0,5	0,25	0,5	0,8	0,25	0,5	1,0	0,25	0,5	1,25
Max permissible velocity (m/s)	0,6	1,3	0,5	1,0	1,6	0,4	0,8	1,5	0,3	0,6	1,5
Max permissible rpm (1/min)	7690	7630	6470	6120	6000	4590	4660	4570	3610	3670	3640
Acceleration max (m/s ²)	10										

* Short strokes < 100 mm on request

** Long strokes > 2500 mm on request

The function

The new Norgren ELION provides a high performance ball screw actuator with servo motor. The actuator can easily be configured and ordered with the Norgren online tool:

<https://www.norgren.com/uk/en/technical-support/configurators>

or visit our landing page for more information:



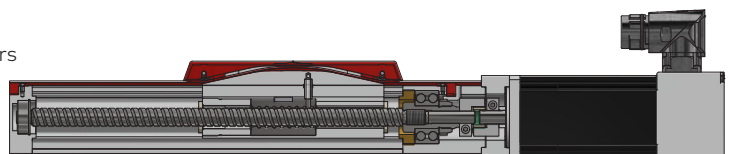

<https://www.norgren.com/uk/en/list/electric-actuators>



List of Content:

General rules	3
Actuator Variants	4
Communications of motors, drives and bus protocols	5
Option Selector	5
Sizing rules and formulas	6
Permissible axial forces Fmax	8
Permissible speeds	9
Life time information	10
Basic dimensions cylinders	13
Mountings and accessories	16
Servo Motors	18
Drives	22
Switches	23
Bus card	27
Cable	27
Accessories for Drives	27

Norgren Family (Actuator ranges in the red frame are shown in this data sheet)

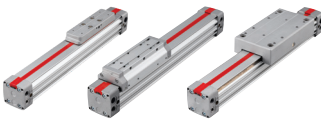
Picture	Function	Data sheet title	Data sheet number
	Electromechanical	E/809000/* Electromechanical actuator with or with or without servo motor	en 1.6.300
	Pneumatic	PRA/802000/M, RA/802000/M, RA/8000, RA/8000/M ISOLine™ 15552 cylinder, double acting	en 1.5.220
	Electromechanical	E/149000/* Electromechanical rodless ball screw actuator with or without servo motor	en 1.6.400
	Electromechanical	E/148000/* Electromechanical tooth belt actuator with or without servo motor	en 1.6.500
	Pneumatic	M/146000, M/146100, M/146200, LIN-TRA®PLUS rodless cylinder Magnetic & Non-magnetic piston, double acting	en 1.6.009



Golden Rules

The Norgren ELION series E/149000 rodless electric actuator is a combination of a ball screw drive actuator and an electric servo motor. Therefore, it must be ensured that the system design, installation, commissioning/start-up and maintenance are carried out by personnel who have the necessary training and competence. They must read the safety information and I&M guide carefully. The actuator must not be used as a mechanical stop. A safety stroke should be considered. For further information, please refer to the comments and drawing on page 7.

Operating conditions

The actuator can perform multiple linear positioning tasks. To prevent damage of the ball screw drive, lateral forces and torque values must be kept within the specifications given in this document. Impact load on the carriage and housing must also be avoided to prevent damage on the ball screw nut and bearings. Mechanical impact on the cover band must be avoided.

Actuator sizing

Ball screw drive actuators like the Norgren ELION are complex mechanical systems transferring the rotational movement of an electric motor into a linear motion. Please be advised that the technical data presented on page 1 may vary for different applications. For exact sizing, please refer to page pages 6 ... 7, use the Norgren online configurator or contact our technical service.

Motor

The sizing of the motor depends on the load cycle applied to the actuator. At all times, the maximum torque requirements must stay below the intermittent torque the motor can apply. To prevent overheating of the motor, the mean torque demand must be below the continuous torque of the motor. For exact sizing, please refer to page pages 6 ... 7, use the Norgren online configurator or contact our technical service.

Mechanical brake

The motors supplied by IMI Precision Engineering can be equipped with a mechanical holding brake. While both hardware and software are designed to high standards of quality and robustness, they are not intended for use as safety functions, i.e. where a fault or failure would result in a risk of injury. Do not apply the brake while the motor shaft is rotating.

The brake can only take a limited number of emergency braking operations and must not be used for repeated dynamic braking.

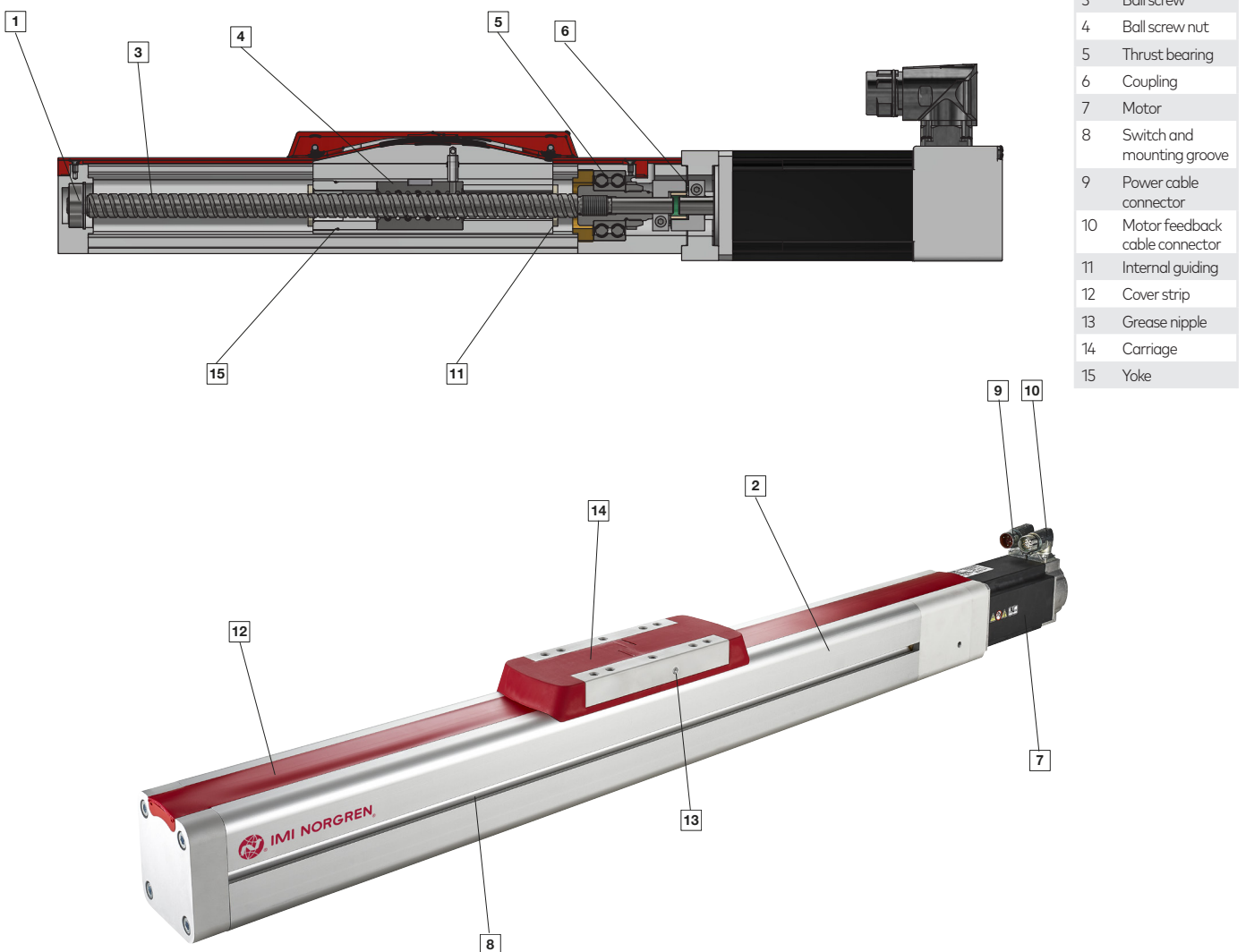

1	Loose bearing
2	Profile barrel
3	Ball screw
4	Ball screw nut
5	Thrust bearing
6	Coupling
7	Motor
8	Switch and mounting groove
9	Power cable connector
10	Motor feedback cable connector
11	Internal guiding
12	Cover strip
13	Grease nipple
14	Carriage
15	Yoke

Actuator variants
E/149★★★★/★★★★/★★★★/★★★★

Size Sub. 1	Ball Screw Sub. 2		Spindle support Sub. 3				Motor Kit Sub. 4	Flange/Motor Sub. 5					Stroke (mm) Sub. 7		
			0	2	4	6			Resolver Absolute (multi turn) Holding brake, resolver Holding brake, absolute (multi turn)	Sub. 6					
□ 48 048	12x5	05	0	2	4		B	No Motor	X	X					100 ... 1280
							C	No motor			08, 09, *				
	D	No motor, flange □40; ØN=30; ØM=46					X	1							
		No motor, flange □55; ØN=40; ØM=63						2							
12x10	10							E	A	B	M	N			
□ 60 060	16x5	05	0	2	4	6	B	No Motor	X	X					100 ... 2500
							C	No motor			09, 14, *				
	D	No motor, flange □55; ØN=40; ØM=63					X	1							
		No motor, flange □67; ØN=60; ØM=75						2							
16x10	10							E	A	B	M	N			
16x16	16							J							
□ 80 080	20x5	05	0	2	4	6	B	No Motor	X	X					100 ... 2500
							C	No motor			14, *				
	D	No motor, flange □67; ØN=60; ØM=75					X	1							
		No motor, flange □67 (2,45 Nm)					J								
20x10	10							N	A	B	M	N			
20x20	20														
□ 100 100	25x5	05	0	2	4	6	B	No Motor	X	X					100 ... 2500
							C	No motor			14, 19, *				
	D	No motor, flange □67; ØN=60; ØM=75					X	1							
		No motor, flange □89; ØN=80; ØM=100						2							
25x10	10							N	A	B	M	N			
25x25	25							R							

* = individual Actuator shaft Ø mm on request

Communications of motors, drives and bus protocols

Symbol	Bus Protocol - Option Module Card										Standard model drive	Description	Page
	□55	□67	□89	SI-PROFINET RTV2	SI-PROFIBUS	SI-EtherNet	SI-EtherCAT	SI-CANopen	SI-DeviceNet	SI-I/O			
	X	X									QE/D01400030	Standard drive with internal Bus- system (for motor size □55 - 67)	22
			X	X	X	X	X	X	X	X	QE/D02400105	Standard drive with internal Bus- system (for motor size □89)	

Option selector

E/149**/****/****/******

<table border="1"> <thead> <tr> <th>Actuator size □</th> <th>Substitute 1</th> </tr> </thead> <tbody> <tr><td>48</td><td>048</td></tr> <tr><td>60</td><td>060</td></tr> <tr><td>80</td><td>080</td></tr> <tr><td>100</td><td>100</td></tr> </tbody> </table> <table border="1"> <thead> <tr> <th>Spindle pitch</th> <th>Substitute 2</th> </tr> </thead> <tbody> <tr><td>5</td><td>05</td></tr> <tr><td>10</td><td>10</td></tr> <tr><td>16</td><td>16</td></tr> <tr><td>20</td><td>20</td></tr> <tr><td>25</td><td>25</td></tr> </tbody> </table> <table border="1"> <thead> <tr> <th>Spindle support</th> <th>Substitute 3</th> </tr> </thead> <tbody> <tr><td>0</td><td>0</td></tr> <tr><td>2</td><td>2</td></tr> <tr><td>4</td><td>4</td></tr> <tr><td>6</td><td>6</td></tr> </tbody> </table>	Actuator size □	Substitute 1	48	048	60	060	80	080	100	100	Spindle pitch	Substitute 2	5	05	10	10	16	16	20	20	25	25	Spindle support	Substitute 3	0	0	2	2	4	4	6	6	<table border="1"> <thead> <tr> <th>Order stroke ** (mm)</th> <th>Substitute 7</th> </tr> </thead> <tbody> <tr><td>100 ... 4100</td><td></td></tr> </tbody> </table> <table border="1"> <thead> <tr> <th>Motor / Feedback / Brake</th> <th>Substitute 6</th> </tr> </thead> <tbody> <tr><td>Motor with resolver, without brake</td><td>A</td></tr> <tr><td>Motor with Absolute (Multi turn), without brake</td><td>B</td></tr> <tr><td>Motor with resolver, with brake</td><td>M</td></tr> <tr><td>Motor with Absolute (Multi turn), with brake</td><td>N</td></tr> <tr><td>No motor, no coupling, with housing</td><td>X</td></tr> <tr><td>No motor, small flange</td><td>1</td></tr> <tr><td>No motor, big flange</td><td>2</td></tr> </tbody> </table> <table border="1"> <thead> <tr> <th>Flange</th> <th>Substitute 5</th> </tr> </thead> <tbody> <tr><td>Flange for motor □55; 1,05 Nm</td><td>E</td></tr> <tr><td>Flange for motor □67, 2,45 Nm</td><td>J</td></tr> <tr><td>Flange for motor □67; 3,50 Nm</td><td>N</td></tr> <tr><td>Flange for motor □89; 6,90 Nm</td><td>R</td></tr> <tr><td>No motor</td><td>X</td></tr> </tbody> </table> <table border="1"> <thead> <tr> <th>Motor kit</th> <th>Substitute 4</th> </tr> </thead> <tbody> <tr><td>Actuator only, no coupling, with coupling housing</td><td>B</td></tr> <tr><td>Actuator only, with coupling, with coupling housing</td><td>C</td></tr> <tr><td>Use Sub. 5 & 6 for motor shaft diameter E/149****/****/C**/****</td><td></td></tr> <tr><td style="text-align: right;">08 ... 20 e.g. 08 = 8 mm motor shaft 09 = 9 mm motor shaft ... 14 = 14 mm motor shaft</td><td></td></tr> <tr><td>Actuator only, with coupling, with coupling housing, with motor flange</td><td>D</td></tr> </tbody> </table>	Order stroke ** (mm)	Substitute 7	100 ... 4100		Motor / Feedback / Brake	Substitute 6	Motor with resolver, without brake	A	Motor with Absolute (Multi turn), without brake	B	Motor with resolver, with brake	M	Motor with Absolute (Multi turn), with brake	N	No motor, no coupling, with housing	X	No motor, small flange	1	No motor, big flange	2	Flange	Substitute 5	Flange for motor □55; 1,05 Nm	E	Flange for motor □67, 2,45 Nm	J	Flange for motor □67; 3,50 Nm	N	Flange for motor □89; 6,90 Nm	R	No motor	X	Motor kit	Substitute 4	Actuator only, no coupling, with coupling housing	B	Actuator only, with coupling, with coupling housing	C	Use Sub. 5 & 6 for motor shaft diameter E/149****/****/C**/****		08 ... 20 e.g. 08 = 8 mm motor shaft 09 = 9 mm motor shaft ... 14 = 14 mm motor shaft		Actuator only, with coupling, with coupling housing, with motor flange	D
Actuator size □	Substitute 1																																																																												
48	048																																																																												
60	060																																																																												
80	080																																																																												
100	100																																																																												
Spindle pitch	Substitute 2																																																																												
5	05																																																																												
10	10																																																																												
16	16																																																																												
20	20																																																																												
25	25																																																																												
Spindle support	Substitute 3																																																																												
0	0																																																																												
2	2																																																																												
4	4																																																																												
6	6																																																																												
Order stroke ** (mm)	Substitute 7																																																																												
100 ... 4100																																																																													
Motor / Feedback / Brake	Substitute 6																																																																												
Motor with resolver, without brake	A																																																																												
Motor with Absolute (Multi turn), without brake	B																																																																												
Motor with resolver, with brake	M																																																																												
Motor with Absolute (Multi turn), with brake	N																																																																												
No motor, no coupling, with housing	X																																																																												
No motor, small flange	1																																																																												
No motor, big flange	2																																																																												
Flange	Substitute 5																																																																												
Flange for motor □55; 1,05 Nm	E																																																																												
Flange for motor □67, 2,45 Nm	J																																																																												
Flange for motor □67; 3,50 Nm	N																																																																												
Flange for motor □89; 6,90 Nm	R																																																																												
No motor	X																																																																												
Motor kit	Substitute 4																																																																												
Actuator only, no coupling, with coupling housing	B																																																																												
Actuator only, with coupling, with coupling housing	C																																																																												
Use Sub. 5 & 6 for motor shaft diameter E/149****/****/C**/****																																																																													
08 ... 20 e.g. 08 = 8 mm motor shaft 09 = 9 mm motor shaft ... 14 = 14 mm motor shaft																																																																													
Actuator only, with coupling, with coupling housing, with motor flange	D																																																																												

For combinations of actuator variants consult our technical service.

This option selector explains only the actuator-variants.

Additional variants/options are not possible.

Detail's see table on page 4.

**Available 100 ... 4100 mm (short strokes < 100 mm and > 2500 mm on request)

Sizing Rules and Formulas for loading values

1. Definition of the load cycle

The load cycle includes all movements of the actuator. For every step, the following values must be defined:

- Direction of the movement
- Rotational position (alignment) of the carriage (top, side, down)
- End position of the movement
- External load mass
- Offset position of the center of gravity of the load mass in relation to the carriage
- Acceleration and deceleration
- Maximum velocity
- Constant external forces
- Offset position of the force application in relation to the carriage
- Possible pause times at the end of the movement

Alignment (Roll)

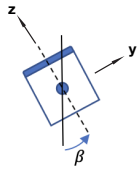

Direction (Pitch)

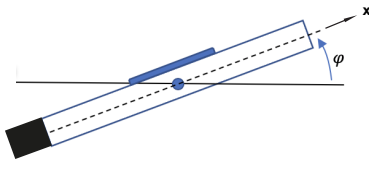

Due to the high positioning accuracy of the Norgren ELION actuators, the number of steps in one cycle is not limited.

2. Calculation of the forces and torques acting on the actuator

For a basic selection of the actuator, the knowledge of the acting forces during the load cycle is essential. For each movement of the load, all forces and torques acting on the actuator must be defined. This includes both external forces applied on the carriage and gravitational forces caused by the load mass applied.

2.1 Calculation of gravitational forces depending on alignment and direction

The Norgren ELION rodless actuator is equipped with an elaborated internal guiding system. To select the size of actuator fitting the application, all torques and forces acting on the bearings must be calculated.

As a first step, the gravitational forces caused by the load mass and the moving mass of the actuator are transformed into the actuator coordinate system:

$$F_{x,g,load} = -m_{load} \cdot g \cdot \sin(\varphi)$$

$$F_{x,g,act} = -m_{mov,act} \cdot g \cdot \sin(\varphi)$$

$$F_{y,g,load} = -m_{load} \cdot g \cdot \sin(\beta) \cdot \cos(\varphi)$$

$$F_{y,g,act} = -m_{mov,act} \cdot g \cdot \sin(\beta) \cdot \cos(\varphi)$$

$$F_{z,g,load} = -m_{load} \cdot g \cdot \cos(\beta) \cdot \cos(\varphi)$$

$$F_{z,g,act} = -m_{mov,act} \cdot g \cdot \cos(\beta) \cdot \cos(\varphi)$$

2.2 Calculation of torque and force values applied on the carriage

The total forces applied on the carriage are calculated as follows:

$$F_{x,a,load} = m_{load} \cdot a$$

$$F_{x,a,act} = m_{mov,act} \cdot a$$

$$F_{x,tot} = F_{x,g,load} + F_{x,a,act} + F_{x,a,load} + F_{x,a,act} + F_{x,ext}$$

$$F_{y,tot} = F_{y,g,load} + F_{y,a,act} + F_{y,ext}$$

$$F_{z,tot} = F_{z,g,load} + F_{z,a,act} + F_{z,ext}$$

The torque values applied are calculated using these forces together with the lever arms through the offset of both the Center of Gravity of the external load and the application point of the external forces:

$$M_{spindle} = 1.2 \cdot F_{x,tot} \cdot \frac{P_{spindle}}{2\pi}$$

$$M_x = F_{z,g,load} \cdot \Delta y_{COG} + F_{z,ext} \cdot \Delta y_{ext} - F_{y,g,load} \cdot \Delta z_{COG} - F_{y,ext} \cdot \Delta z_{ext} - M_{spindle}$$

$$M_y = (F_{x,g,load} + F_{x,a,load}) \cdot \Delta z_{COG} + F_{x,ext} \cdot \Delta z_{ext} - F_{z,g,load} \cdot \Delta x_{COG} - F_{z,ext} \cdot \Delta x_{ext}$$

$$M_z = F_{y,g,load} \cdot \Delta x_{COG} + F_{y,ext} \cdot \Delta x_{ext} - (F_{x,g,load} + F_{x,a,load}) \cdot \Delta y_{COG} - F_{x,ext} \cdot \Delta y_{ext}$$

The offset in z-direction must be corrected by the distance between the COG of the moving parts of the actuator and the top of the carriage

-> $z_{COG} = z_i + z_o$ using the following values for Δz_o :

Size	48	60	80	100
Δz_o	37 mm	47 mm	61,5 mm	75,5 mm

To evaluate whether the forces and torques can be tolerated by the internal bearing system, they are normalised using the maximum tolerable values in every direction and then summarised. If the sum is ≤ 1 the bearing is sufficiently sized for the load:

$$\frac{|M_x|}{M_{x,max}} + \frac{|M_y|}{M_{y,max}} + \frac{|M_z|}{M_{z,max}} + \frac{|\sum_j F_{y,tot,j}|}{F_{y,max}} + \frac{|\sum_i F_{z,tot,i}|}{F_{z,max}} \leq 1$$

The maximum values $M_{x,max}$, $M_{y,max}$, $M_{z,max}$, $F_{y,max}$ and $F_{z,max}$ depend on the velocity of the movement and can be estimated using the diagrams on page 11.

$P_{spindle}$	Pitch of ball screw	m
a	Acceleration/deceleration	m/s ²
$m_{mov,act}$	Moving mass of the actuator	kg
m_{load}	Load mass applied on actuator	kg
$\Delta x, \Delta y, \Delta z$	Distance of forces/loads to actuator centre	m
β	Position of carriage	°
φ	Direction of movement	°
g	Gravitational acceleration	m/s ²

3. Selection of the actuator and motor

3.1 Spindle pitch and number of supports

The pitch of the driving spindle can be defined by the maximum velocity of the load cycle.

$$v_{cycle} \leq v_{max,actuator}$$

The correlation between the maximum stroke length and the maximum velocity of the actuator must be considered as well as the different spindle pitch values defining the maximum velocity.

To avoid oscillations of the spindle, the implementation of additional spindle supports can be necessary. Allowable values for the maximum velocity with and without spindle supports can be found in the diagrams on page 9. Please note, that the zero stroke length of the actuators increases when spindle supports are installed.

Using the values for stroke length and velocity, the maximum force necessary during the load cycle can be compared to the maximum force applicable to the actuator. Here, the direction of movement has to be considered to prevent buckling of the spindle.

$$F_{tot,max} < F_{max,actuator}$$

3.2 Selection of a motor

For each actuator, two motor sizes are available. The selection of the motor is based on the driving torque T and rotational speed rpm which have to be calculated for each step of the load cycle. All values calculated must be below the intermittent torque the motor can deliver (diagr. pages 18 ... 21).

$$T_{mot,step} = 1,2 \cdot F_{x,tot,step} \cdot \frac{P_{spindle}}{2 \cdot \pi}$$

$$n_{mot,step} = \frac{v_{max,step}}{P_{spindle}}$$

T'	Torque	Nm
n	Rotational speed	min ⁻¹
$v_{max,step}$	Maximum velocity of each step	m/s

To avoid overheating of the motor, the mean torque T_{rms} of the load cycle must be lower than the continuous torque (diagr. pages 18 ... 21).

$$T_{mot,rms} = \sqrt{\sum \left[(T_{mot,step})^2 \cdot \frac{t_{step}}{t_{tot}} \right]}$$

$$n_{mot,rm} = \sqrt{\sum \left[(n_{mot,step})^2 \cdot \frac{t_{step}}{t_{tot}} \right]}$$

4. Estimation of expected life time

The estimated life time of the ball screw drive can be calculated according to DIN ISO 3408-5. Therefore, the mean velocity v_m and the mean force F_m must be calculated.

$$F_m = \sqrt[3]{\sum_{j=1}^n \left(|F_{tot,step,j}| \cdot \frac{|v_{step,j}|}{v_m} \cdot \frac{t_{step,j}}{t_{tot}} \right)}$$

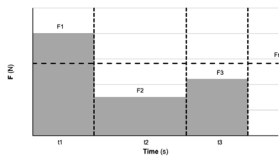

Then, the life time in revolutions is calculated from the dynamic force C of the ball screw nut and the mean force.

$$L = \left(\frac{C}{F_m} \right)^3 \cdot 10^6$$

The life time L_{km} in km is then calculated with the spindle pitch P .

$$L_{km} = L \cdot P_{spindle} \cdot \left(10^{-6} \frac{km}{mm} \right)$$

5. Additional mountings

To avoid bending of the actuator, the installation of additional mountings may be necessary. For each actuator size, the maximum unsupported length can be estimated with the forces in y- and z-direction using the diagrams on page 12.

5. Safety stroke

Disregarding the initial set up, the actuator must not touch its mechanical end stops. A safety stroke should be considered, respecting the application boundaries and environments.

We generally recommend a safety stroke of 20 mm per side for electric rodless actuators. The order stroke = working stroke + safety stroke of 2 x 20 mm.

Please note, that during the initial set up, the actuator might exceed its nominal end position as given (over run "Dimension X") in the drawing below.

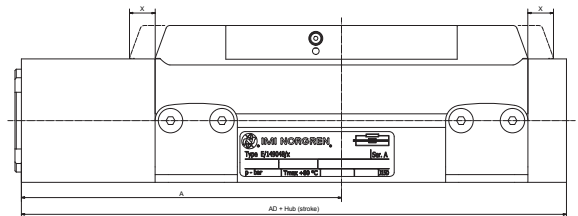

Dimension "X"

10 mm for size 48/60

12 mm for size 80/100

For more information please visit:

<https://www.norgren.com/uk/en/list/electric-actuators>

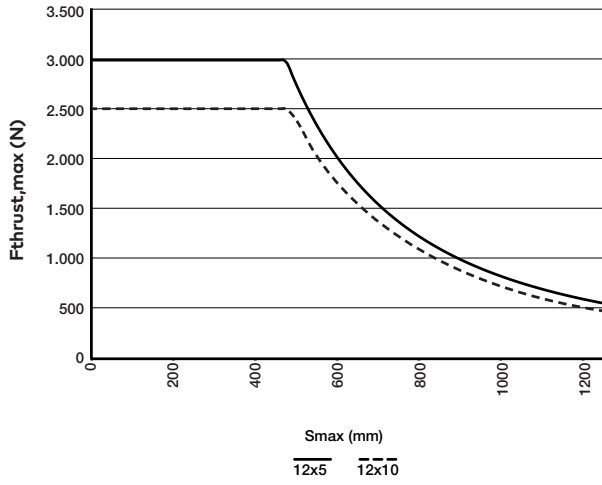
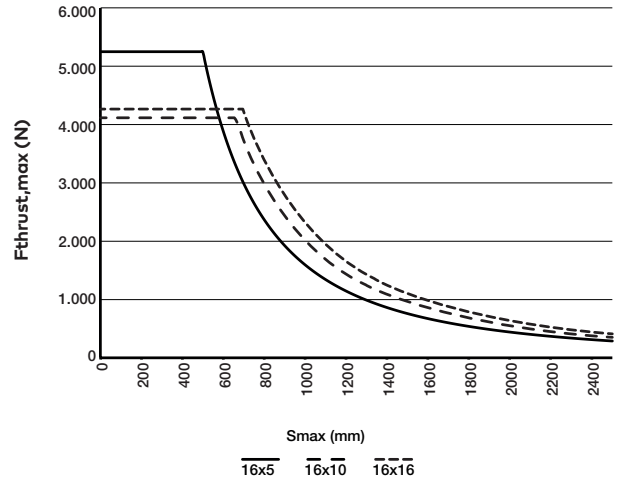
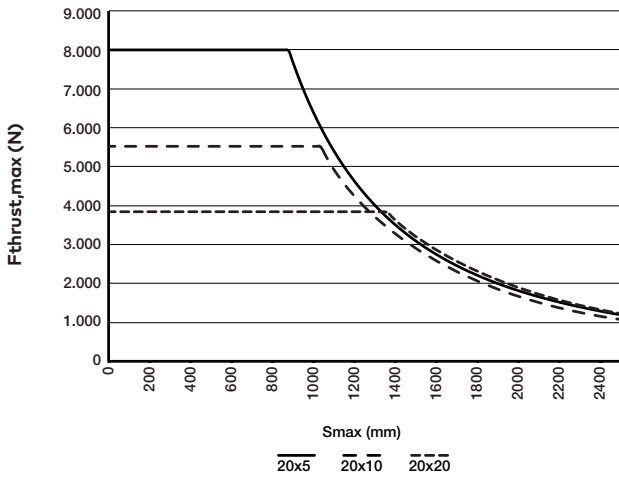
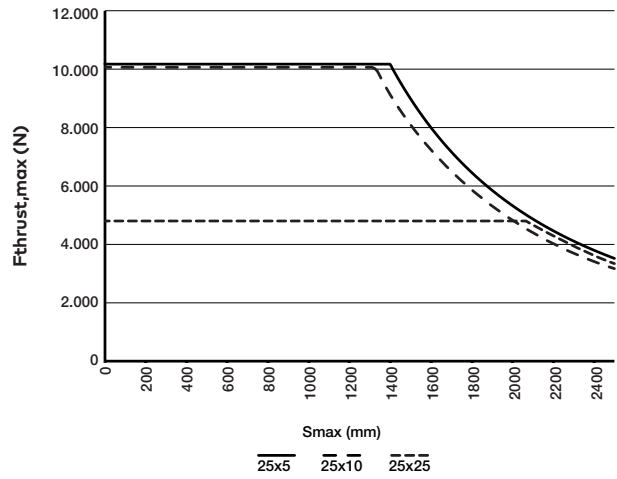
Permissible axial forces
E/149048

E/149060

E/149080

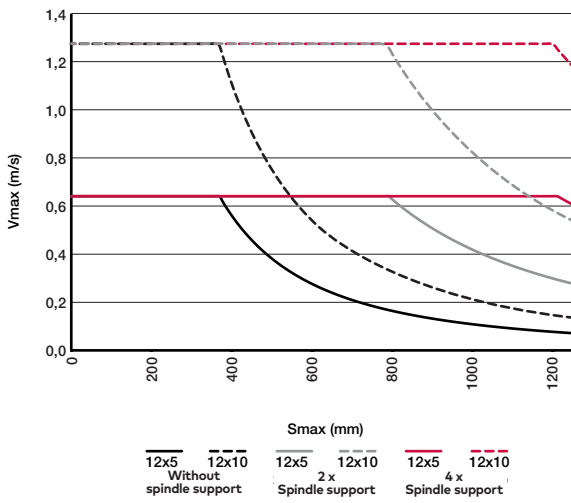
E/149100

Permissible speeds

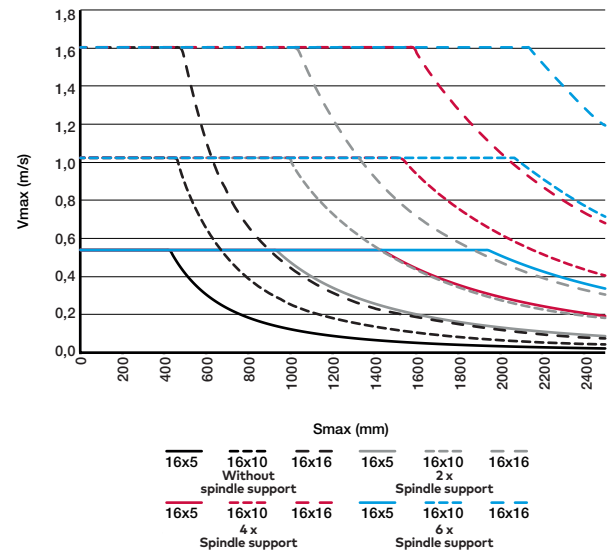
E/149048



E/149060



E/149080

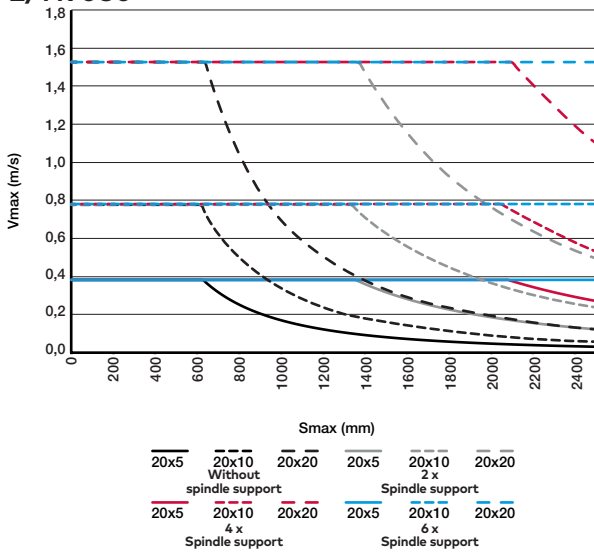

E/149100

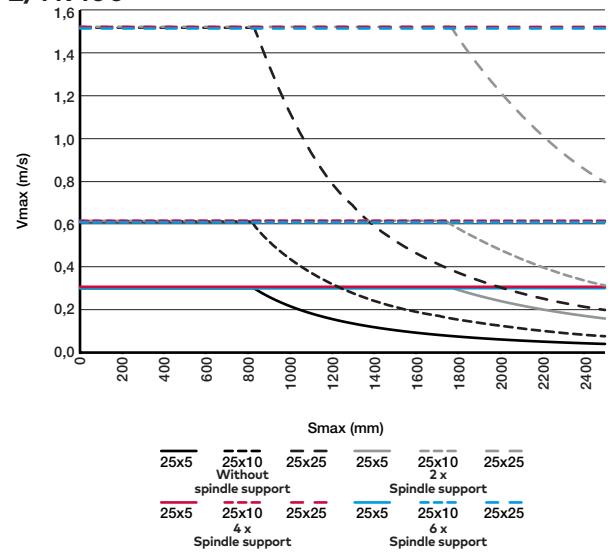

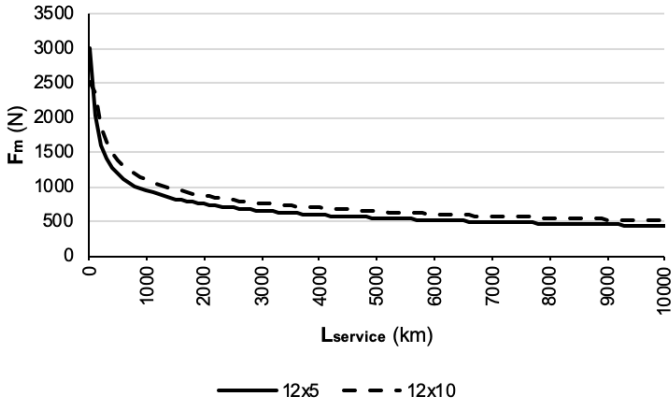
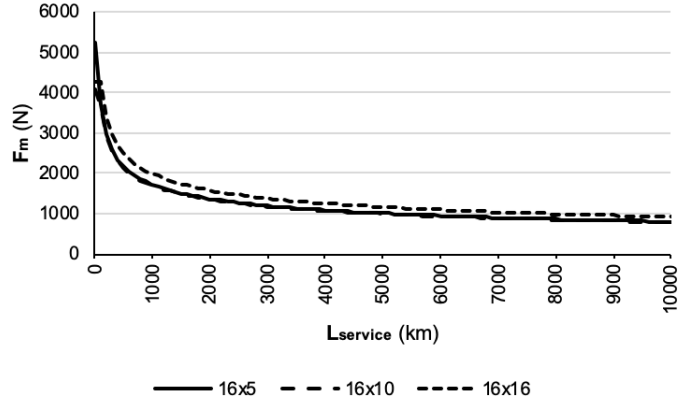
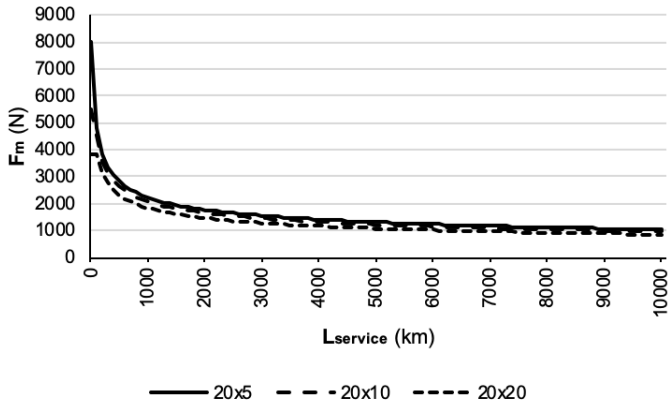
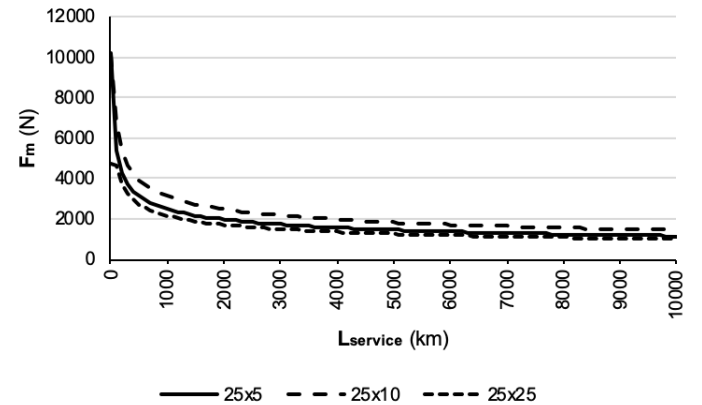
Force Life Time
E/149048

E/149060

E/149080

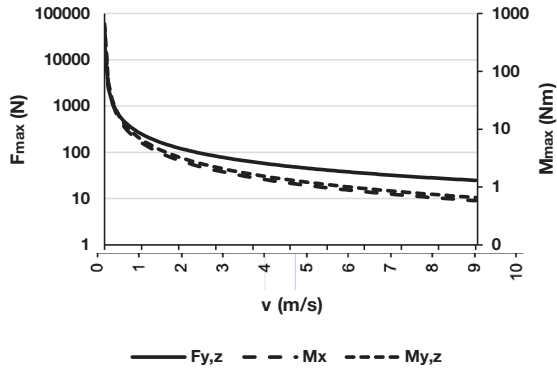
E/149100

Max. forces and moments

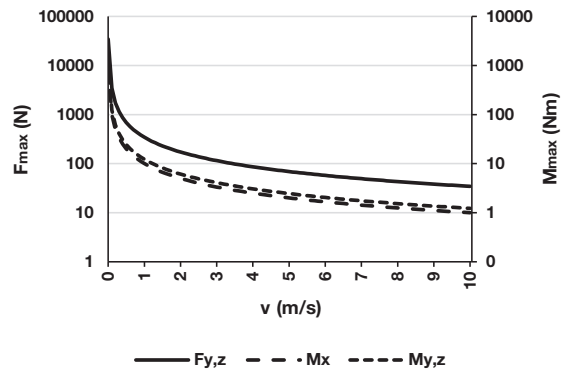
E/149048



E/149060



E/149080

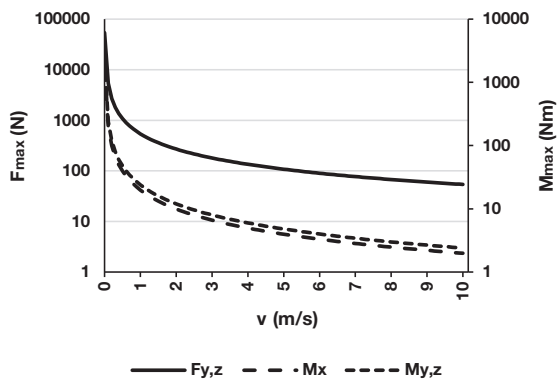

E/149100

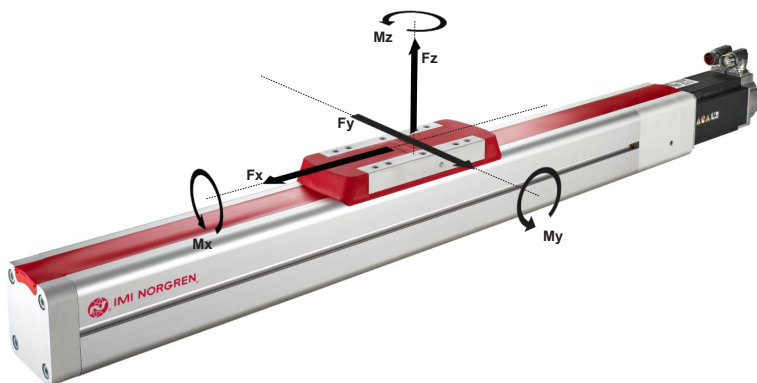
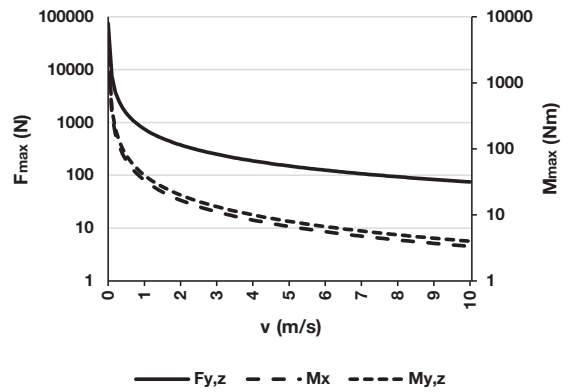

$$\frac{|M_x|}{M_{x,max}} + \frac{|M_y|}{M_{y,max}} + \frac{|M_z|}{M_{z,max}} + \frac{|\sum_j F_{y,tot,j}|}{F_{y,max}} + \frac{|\sum_i F_{z,tot,i}|}{F_{z,max}} \leq 1$$

Unsupported length

E/149048

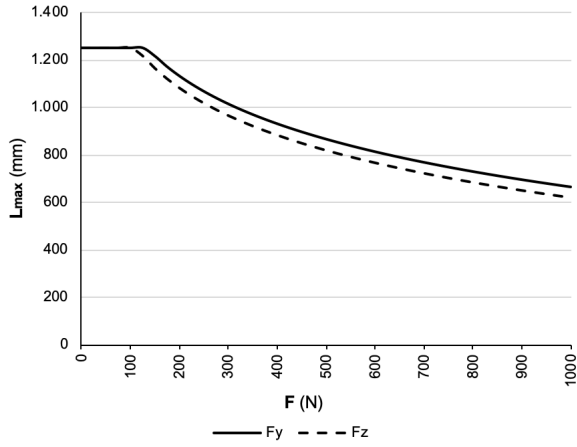

E/149060

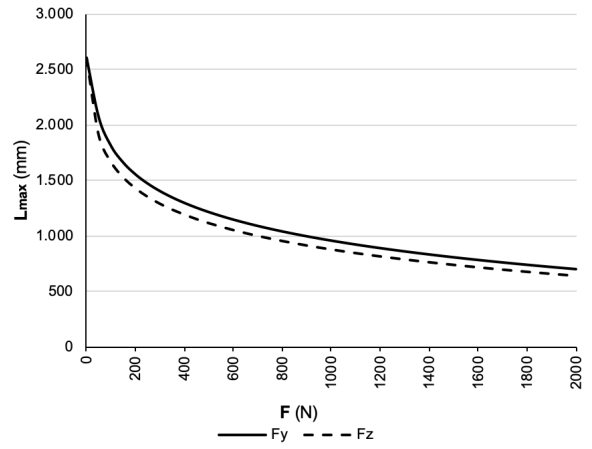

E/149080

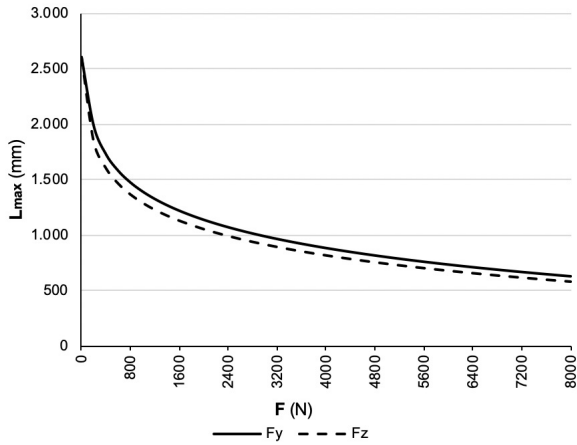

E/149100

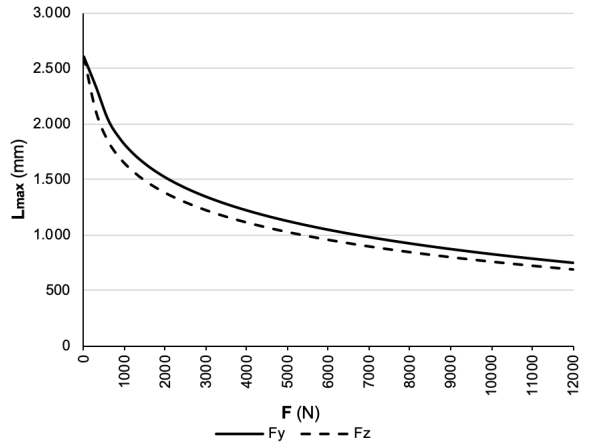

**Basic dimensions
E/149000/***/BXX**
Actuator without motor, without coupling, with housing for customer individual motor

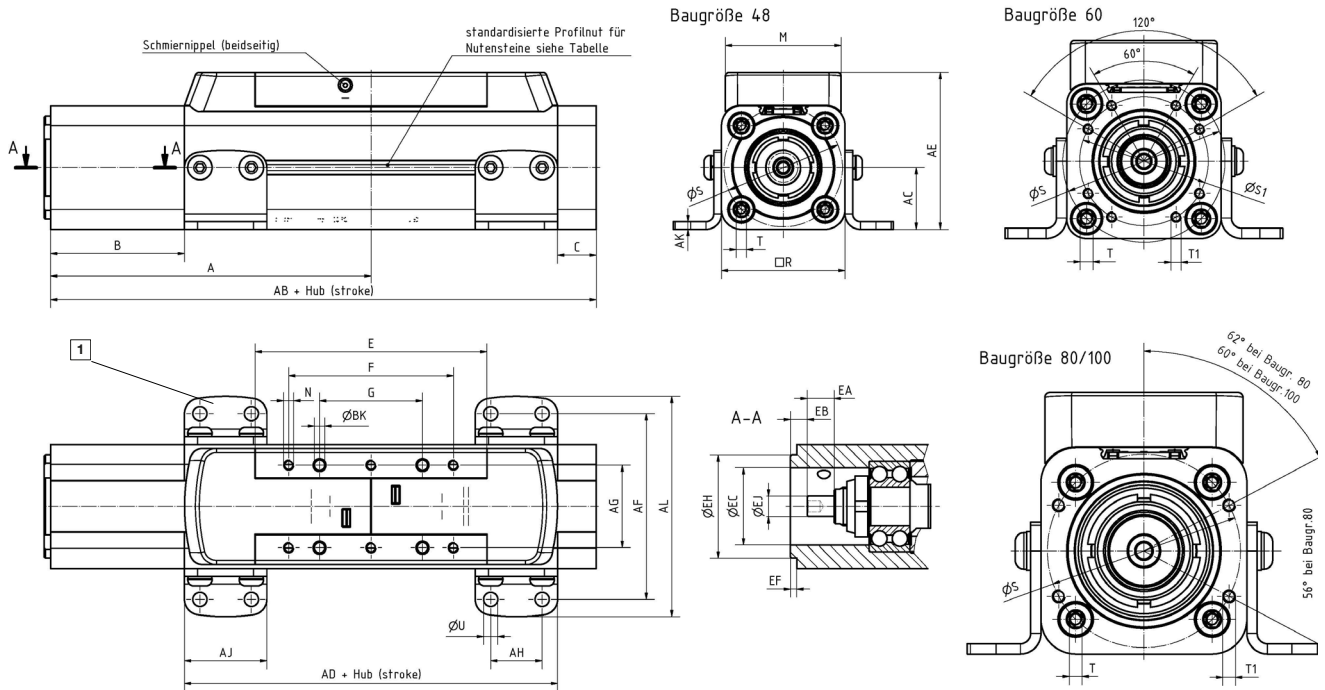
 Dimensions in mm
Projection/First angle

1 Two site supports include with delivery

Size	A	AB	AC	AD	AE	AF	AG	AH	AJ	AK	AL	B	BK	C	E	EA	EB	Typ
48	124,5	212	24	max 145	61	72	32	20	32	3	85,5	52	4 H7-8 deep	15	90	10,5	6,5	E/149048/BXX
60	158	270,5	30	max 185	77	90	44	28	44	4	108	65,5	5 H7-10 deep	20	120	17,5	5	E/149060/BXX
80	195,5	335,5	40	max 230	101,5	115	56	36	56	4	137,5	80,5	6 H7-10 deep	25	150	20,5	7	E/149080/BXX
100	237,5	402,5	50	max 270	125,5	140	74	42	66	5	166,5	102,5	8 H7-13 deep	30	190	20,5	13	E/149100/BXX

Size	EC	EF	EH	EJ	F	G	R	S	S1	T	T1	N	M	U	Weight at 0 mm (kg)	Weight per 100mm (kg)	Typ
48	30	2,5	40 H7	8 h7	64	40	48	46	-	M4-33/12 deep	-	M4-9 deep	45	5,5	1,5	0,3	E/149048/BXX
60	35	2,5	40 H7	10 h7	90	60	60	63	50	M5-39/13 deep	M4-12 deep	M5-13 deep	57	6,6	3,1	0,5	E/149060/BXX
80	54	2,5	60 H7	13 h7	110	80	80	75	-	M5-47/16 deep	M5-13 deep	M5-16 deep	77	9	6,5	0,9	E/149080/BXX
100	72	2,5	80 H7	17 h7	150	110	100	100	-	M6-52/16 deep	M6-18 deep	M6-16 deep	97	11	12,5	1,3	E/149100/BXX

Attention:

Using spindle supports will increase the dimension AB as follows:

- for size 48 and 60: 40 mm per 2 spindle supports
- for size 80 and 100: 50 mm per 2 spindle supports

Basic dimensions
E/149000/*/CXX**
**Actuator without motor, with coupling, with housing
for customer individual motor**

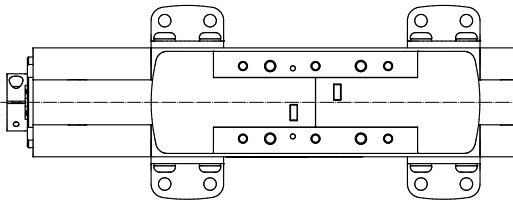
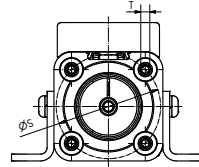
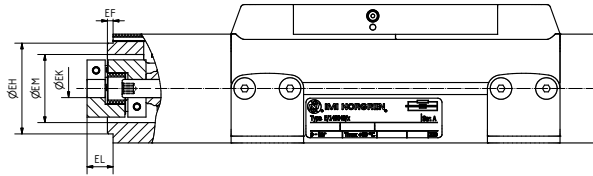
 Dimensions in mm
Projection/First angle

Size	EF	EH	EK	EL	S	T	Weight at 0 mm (kg)	Weight per 100 mm (kg/mm)	Model
48	2.5	40 h7	8	11.5	46	M4-33/12 deep	1,55	0,3	E/149048/C08
48	2,5	40 h7	9	11,5	46	M4-33/12 deep	1,55	0,3	E/149048/C09
60	2.5	40 h7	9	12	63	M5-39/13 deep	3,2	0,5	E/149060/C09
60	2.5	40 h7	14	12	63	M5-39/13 deep	3,2	0,5	E/149060/C14
80	2.5	60 h7	14	25	75	M5-47/16 deep	6,65	0,9	E/149080/C14
100	2.5	80 h7	14	19	100	M6-52/16 deep	12,8	1,3	E/149100/C14
100	2,5	80 h7	19	27	100	M6-52/16 deep	12,8	1,3	E/149100/C19

Basic dimensions
E/149000/*/D****
Actuator with axial motor mounting kit

Dimensions in mm
 Projection/First angle

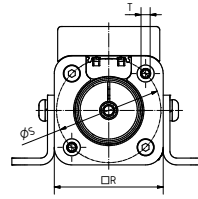
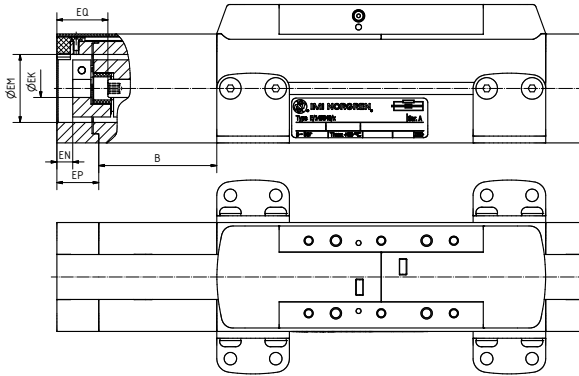

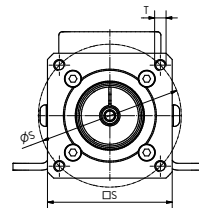
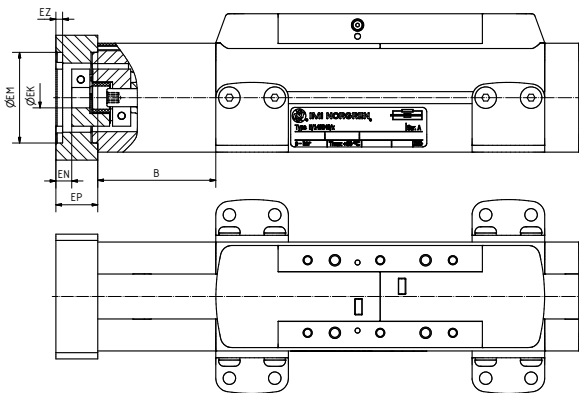

Size	EK	EM	EN	EP	EQ	EZ	R	S	T	Weight without motor at 0 mm (kg)	Weight per 100 mm (kg/mm)	Model
48	8	30 G7	12	23,5	27	-	48	46	M4-51/12 deep	2,1	0,3	E/149048/***/DX1
60	9	40 G7	7	19	21	-	60	63	M5-58/13 deep	4,1	0,5	E/149060/***/DX1
60	9	40 G7	7	19	21	-	60	63	M5-58/13 deep	4,1	0,5	E/149060/***/DE*
80	14	60 G7	7	32	36	3	80	75	M5-79/ 16 deep	7,8	0,9	E/149080/***/DX1
80	14	60 G7	7	32	36	3	80	75	M5-79/ 16 deep	7,8	0,9	E/149080/***/DJ*
80	14	60 G7	7	32	36	3	80	75	M5-79/ 16 deep	7,8	0,9	E/149080/***/DN*
100	14	80 G7	7	26	36	3	100	75	M5-15 deep	14,3	1,3	E/149100/***/DX1
100	14	80 G7	7	26	36	3	100	75	M5-15 deep	14,3	1,3	E/149100/***/DN*





Size	EK	EM	EN	EP	EQ	EZ	R	S	T	Weight without motor at 0 mm (kg)	Weight per 100 mm (kg/mm)	Model
48	9	40 G7	7	18,5	22	3	55	63	M4-33/12 deep	3,25	0,3	E/149048/***/DX2
48	9	40 G7	7	18,5	22	3	55	63	M4-33/12 deep	3,25	0,3	E/149048/***/DE*
60	14	60 G7	18,5	30,5	33	3	70	75	M5-15 deep	5,2	0,5	E/149060/***/DX2
60	14	60 G7	18,5	30,5	33	3	70	75	M5-15 deep	5,2	0,5	E/149060/***/DJ*
100	19	80 G7	7	34	44	3	100	100	M6-86/16 deep	16,1	1,3	E/149100/***/DX2
100	19	80 G7	7	34	44	3	100	100	M6-86/16 deep	16,1	1,3	E/149100/***/DR*

Mountings

	Mountings V	Groove key
		
□	Page 17	Page 17
48	QE/148048/18	M/P74065
60	QE/148060/18	M/P74066
80	QE/148080/18	M/P41858
100	QE/148100/18	M/P76219

Magnetically operated switches

	M/50/**	Switch mounting bracket
		
∅	Page 23	
48		-
60		M/P76273
80		M/P76274
100		M/P76275

	QE/M*
	
□	Page 18 ... 21
55 (1,05 Nm)	QE/M05530/**
67 (2,45 Nm)	QE/M06730/**
67 (3,50 Nm)	QE/M06730/**
89 (6,90 Nm)	QE/M08930/**

Mountings Centre support V

Dimensions in mm
Projection/First angle

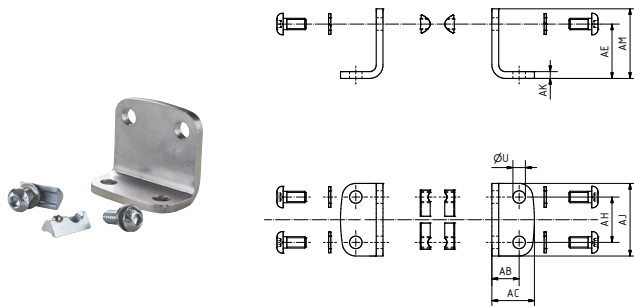

Size	AB	AC	AE	AH	AK	AJ	AM	U	Model
48	12	18.7	24	20	3	32	30.7	5.5	QE/148048/18
60	15	24	30	28	4	44	39	6.6	QE/148060/18
80	17.5	28.7	40	36	4	56	51.2	9	QE/148080/18
100	20	33.2	50	42	5	66	63.2	11	QE/148100/18

Groove key for guide profile

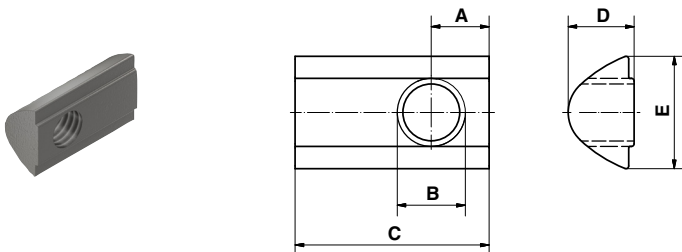

Size	A	B	C	D	E	Weight (kg)	Model
48	4	M5	12	4,25	8	0,01	M/P74065
60	4,5	M6	17	6,25	10,5	0,02	M/P74066
80	7,5	M8	23	7,3	13,5	0,03	M/P41858
100	8,5	M10	28,5	9,7	16,5	0,04	M/P76219

- > Compact servo motor with high dynamics
- > Patented rotor technology
- > Holding brake available
- > Very high torque is required during rapid acceleration and deceleration profiles
- > IP65
- > Rated torques from 1,05 Nm up to 6,9 Nm
- > Optimised for pulse-duty application (300% overload)
- > 400 V three-phase
- > Two different feedback systems (Resolver or Absolute (Multi turn))



Technical features

Voltage:

400 VAC

Rated current:

0,7 ... 9 A

Power:

0,16 ... 3,3 kW

Rated speed (rpm):

3000

Ambient temperature:

0 ... 40 °C (32 ... 104 °F)

Humidity:

0 ... 95%

IP Protection rate:

IP65

Plug in for motor cable

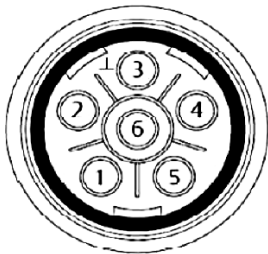

Plug in for feedback cable

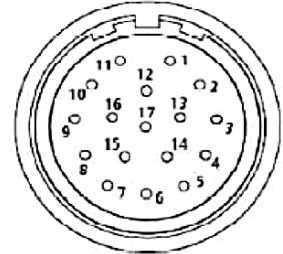
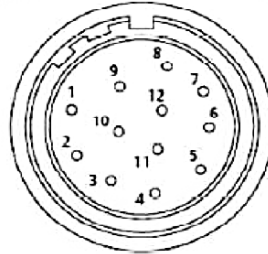

Pin	Function with holding brake	Function without holding brake
1	Phase U (R)	Phase U (R)
2	Phase V (S)	Phase V (S)
3	Ground	Ground
4	Phase W (T)	Phase W (T)
5	Brake +24 V	
6	Brake 0 V	
Shell	Screen	Screen

Pin	Function Resolver	Function Absolute (Multi turn)
1	Excitation High	Thermistor
2	Excitation Low	Thermistor
3	Cos High	Screen (Optical only)
4	Cos Low	
5	Sin High	
6	Sin Low	
7	Thermistor	
8	Thermistor	+ Clock
9		- Clock
10		
11		+ Data
12		- Data
13		- Cos
14		
15		
16		
17		0 Volts
Body	Screen	Screen

For further information please visit:

<http://acim.nidec.com/drives/control-techniques/downloads/user-guides-and-software/unimotorhd>

Motor QE/M05530/*

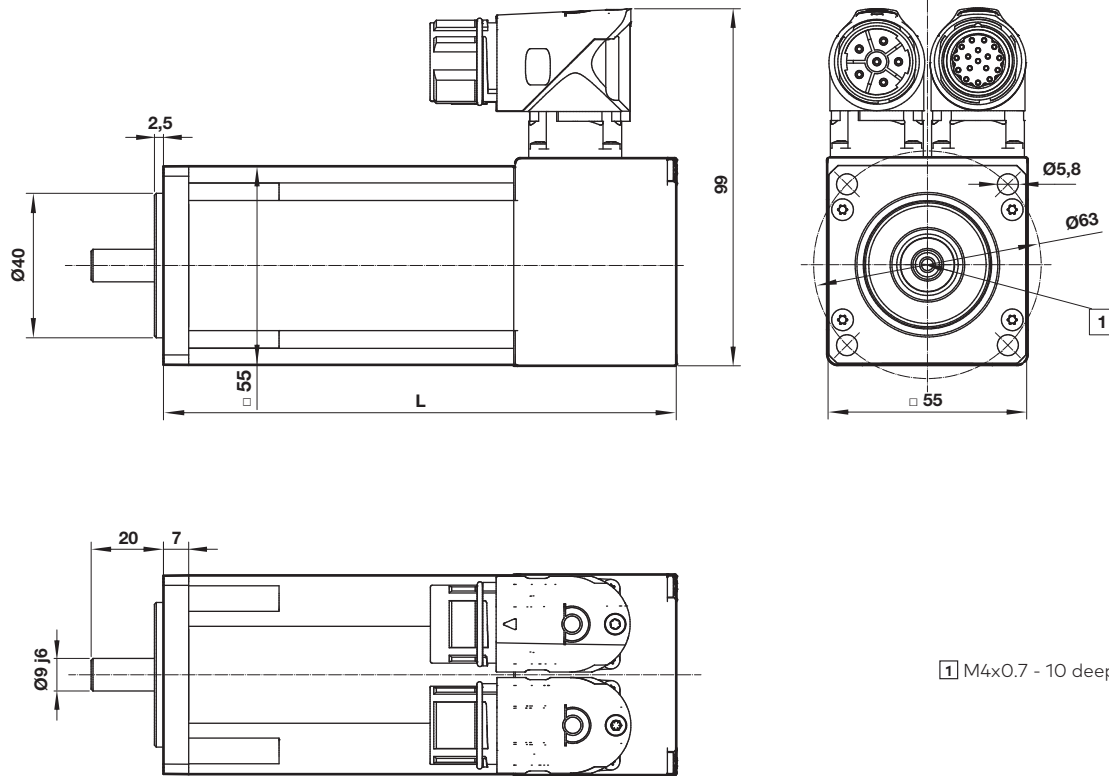
 Dimensions in mm
 Projection/First angle

Motor-code	Feedback system	Rated torque (Nm)	Rated power (kW)	Stall current (A)	Motor stall torque (Nm)	Motor peak torque (Nm)	Braking torque holding brake (Nm)	Inertia (kg m ²)	Brake	L (mm)	Weight (kg)	Nidec reference number	Model
EA	Resolver	1,05	0,33	0,79	1,18	4,72	-	0,000025	-	142	1,5	055UDB300BAARA063090	QE/M05530/EA/09
EB	Absolute (Multi turn)	1,05	0,33	0,79	1,18	4,72	-	0,000025	-	142	1,5	055UDB300BAEGA063090	QE/M05530/EB/09
EM	Resolver	1,05	0,33	0,79	1,18	4,72	1,8	0,000025	x	182	1,9	055UDB305BAARA063090	QE/M05530/EM/09
EN	Absolute (Multi turn)	1,05	0,33	0,79	1,18	4,72	1,8	0,000025	x	182	1,9	055UDB305BAEGA063090	QE/M05530/EN/09

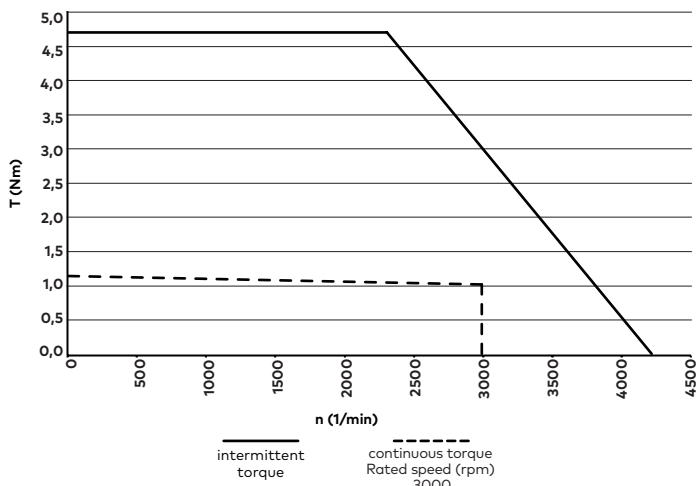
QE/M05530/E*

Motor QE/M06730/*

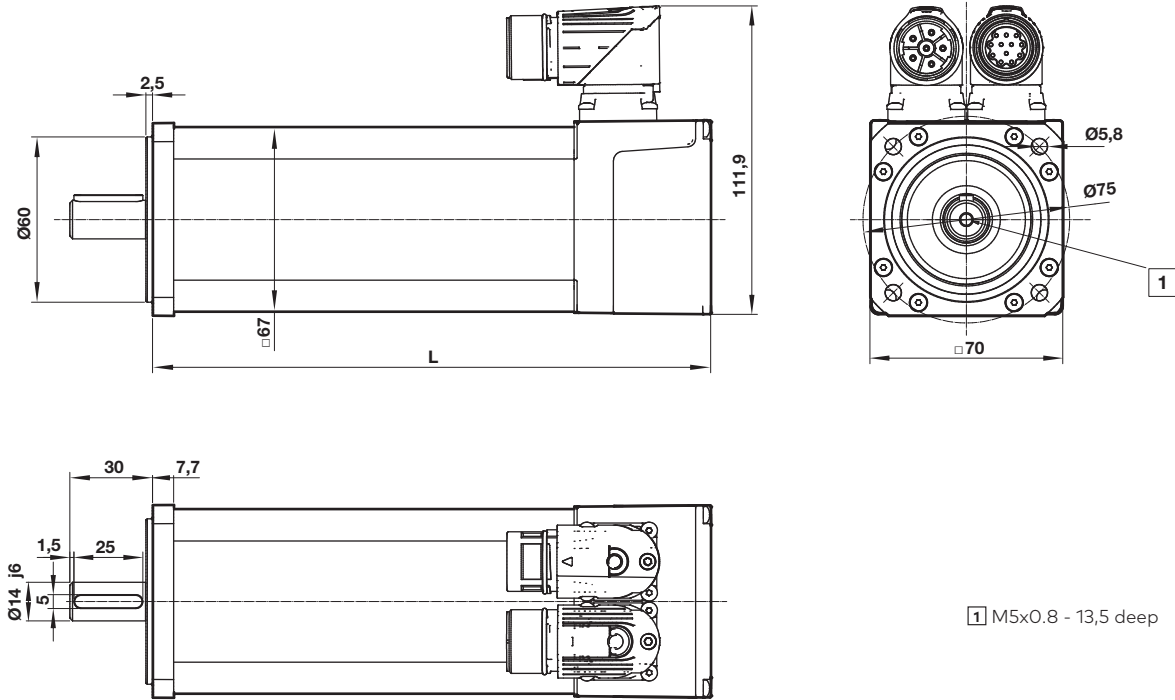
 Dimensions in mm
 Projection/First angle

Motor-code	Feedback system	Rated torque (Nm)	Rated power (kW)	Stall current (A)	Motor stall torque (Nm)	Motor peak torque (Nm)	Braking torque holding brake (Nm)	Inertia (kg m ²)	Brake	L (mm)	Weight (kg)	Nidec reference number	Model
JA	Resolver	2,45	0,77	1,59	2,55	7,65	-	0,000053	-	172,7	2,6	067UDB300BAARA	QE/M06730/JA/14
JB	Absolute (Multi turn)	2,45	0,77	1,59	2,55	7,65	-	0,000053	-	172,7	2,6	067UDB300BAEGA	QE/M06730/JB/14
JM	Resolver	2,45	0,77	1,59	2,55	7,65	2,0	0,000053	x	207,7	3,3	067UDB306BAARA	QE/M06730/JM/14
JN	Absolute (Multi turn)	2,45	0,77	1,59	2,55	7,65	2,0	0,000053	x	207,7	3,3	067UDB306BAEGA	QE/M06730/JN/14
NA	Resolver	3,50	1,10	2,31	3,70	11,10	-	0,000075	-	202,7	3,2	067UDC300BAARA	QE/M06730/NA/14
NB	Absolute (Multi turn)	3,50	1,10	2,31	3,70	11,10	-	0,000075	-	202,7	3,2	067UDC300BAEGA	QE/M06730/NB/14
NM	Resolver	3,50	1,10	2,31	3,70	11,10	2,0	0,000075	x	237,7	3,8	067UDC306BAARA	QE/M06730/NM/14
NN	Absolute (Multi turn)	3,50	1,10	2,31	3,70	11,10	2,0	0,000075	x	237,7	3,8	067UDC306BAEGA	QE/M06730/NN/14

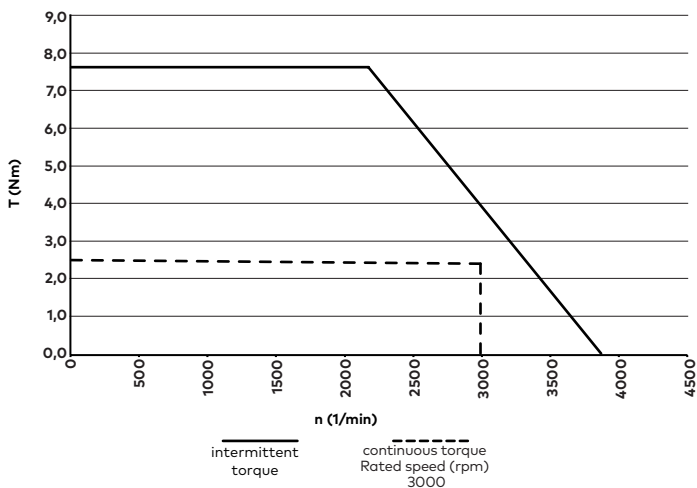
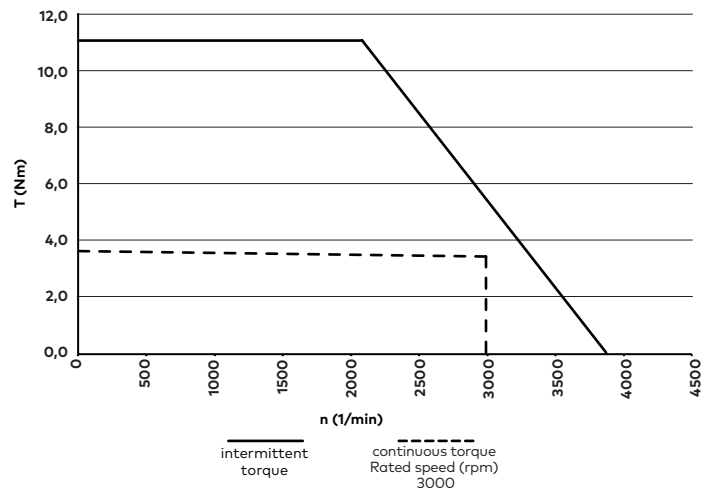
QE/M06730/J*

QE/M06730/N*

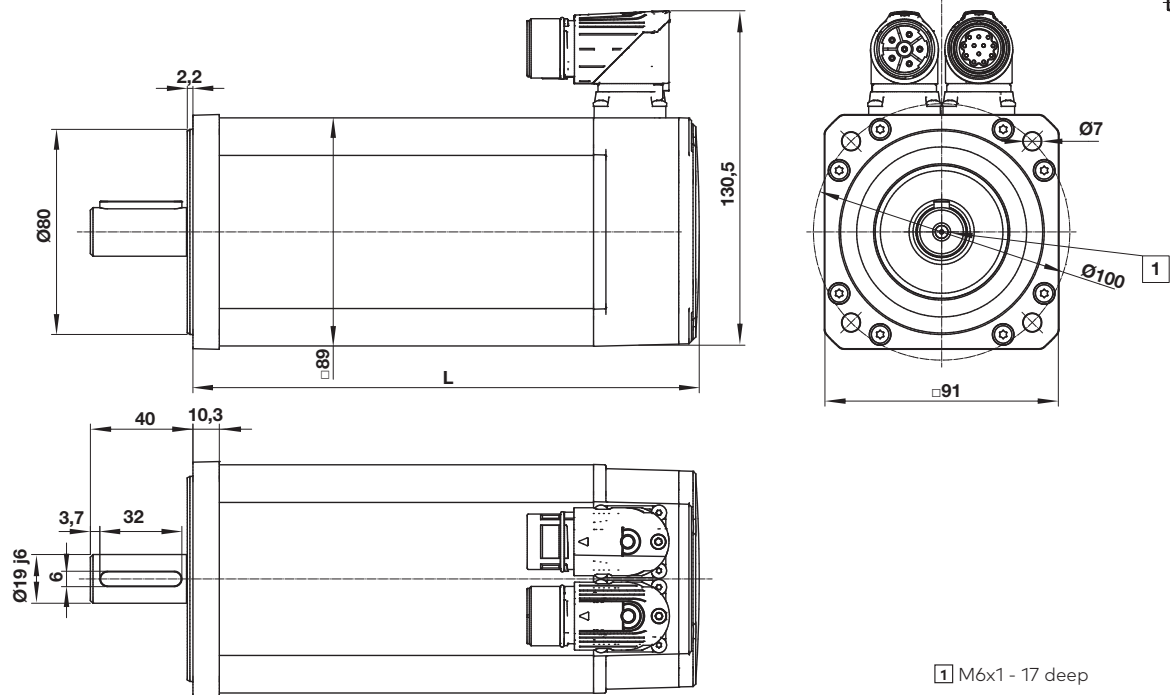
Motor QE/M08930/*

 Dimensions in mm
 Projection/First angle

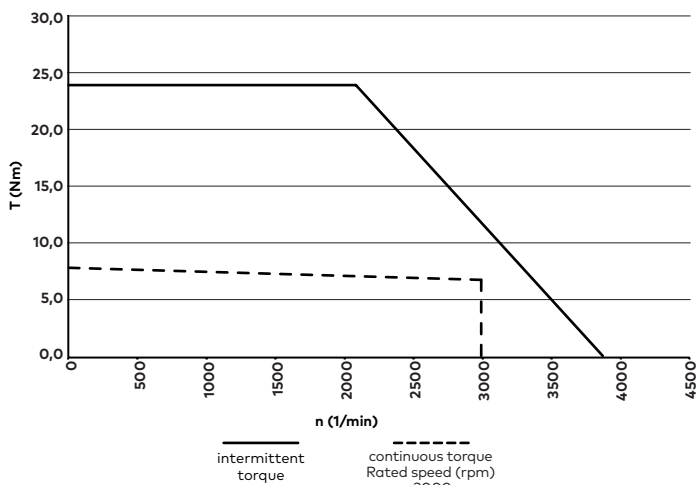
Motor-code	Feedback system	Rated torque (Nm)	Rated power (kW)	Stall current (A)	Motor stall torque (Nm)	Motor peak torque (Nm)	Braking torque holding brake (Nm)	Inertia (kg m ²)	Brake	L (mm)	Weight (kg)	Nidec reference number	Model
RA	Resolver	6,90	2,17	5,0	8,0	24,0	-	0,000234	-	197,8	5,5	089UDC300BAAEA	QE/M08930/RA/19
RB	Absolute (Multi turn)	6,90	2,17	5,0	8,0	24,0	-	0,000234	-	207,8	4,9	089UDC300BAECA	QE/M08930/RB/19
RM	Resolver	6,90	2,17	5,0	8,0	24,0	10,0	0,000234	x	237,9	6,8	089UDC306BAAEA	QE/M08930/RM/19
RN	Absolute (Multi turn)	6,90	2,17	5,0	8,0	24,0	10,0	0,000234	x	247,9	6,2	089UDC306BAECA	QE/M08930/RN/19

QE/M08930/R*

- > 2 Compact drive frame sizes with maximum performance
- > Onboard Advanced Motion Controller for distributed 1.5 axis motion control
- > Integrated Dual Safe Torque Off - "SIL3 and PLe"
- > Option module flexibility
- > Drives available with EtherCAT, PROFINET, PROFIBUS, EtherNet/IP, DeviceNet & CANopen communications
- > Built-in RS485 communications
- > SD Card slot

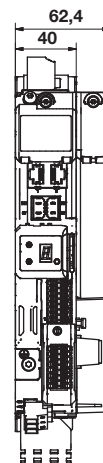
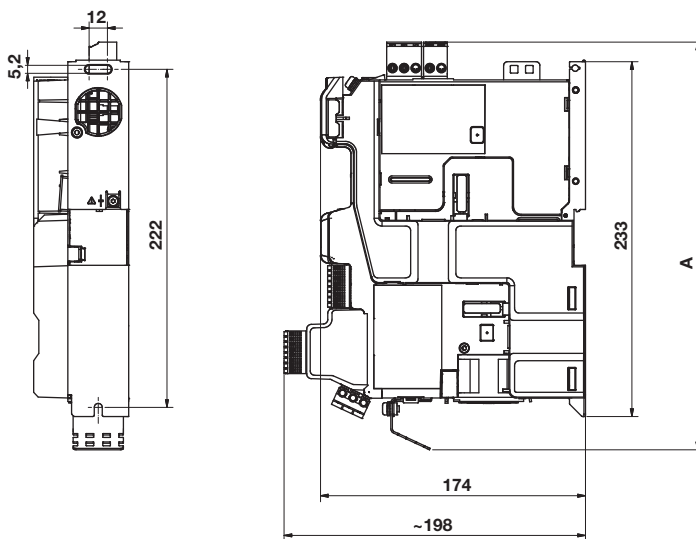

A	B	C	Nidec reference number	Standard model drive
~ 268	233	222	M751-01400030A10100AB110	QE/DO1400030
~ 313	278	267	M751-02400105A10100AB110	QE/DO2400105

Description	Line supply (VAC)	Voltage (V)	Output power (kW):	max. Power (kW)	Rated current (A)	max. Peak current (A)	max. output frequency (Hz)	Overload closed loop	Overload open loop	Nidec reference number	Standard model drive
Standard drive with internal Bus-system (for motor size □55 - 67)	three-phase 380 ... 480 (±10%) at 45 ... 66 Hz	400	0,75	6,5	3	9	599	300% for 0,25 s or 200% for 4 s	150% for 8 s	M751-01400030A10100AB110	QE/DO1400030
Standard drive with internal Bus-system (for motor size □89 - 115)	three-phase 380 ... 480 (±10%) at 45 ... 66 Hz	400	4,0	8,7	10,5	31,5	599	300% for 0,25 s or 200% for 4 s	150% for 8 s	M751-02400105A10100AB110	QE/DO2400105

For further information please visit:

<http://acim.nidec.com/drives/control-techniques/downloads/user-guides-and-software/digitax-hd>

- > Magnetically operated reed switch - Round style
- > Suitable for all cylinder ranges with magnetic piston
- > Switches can be mounted flush with the delivered special adaptor
- > LED indicator on LSU models
- > Alternative variants allow a wide range of application



Technical features

Operation:

M/50/LSU Normally open with LED (yellow)

Switching voltage (Ub):

10 ... 240 VAC/170 VDC

Switching voltage output:

Ub - 2,7 V

Switching current

(see graph overleaf):

0,18 A max.

Switching power:

10 W/10 VA max.

Contact resistance:

150 mΩ

Response time:

1,8 ms

Operating temperature:

-25 ... +80 °C (-13 ... +176 °F)

High temperature version:

+150 °C max.(+302 °F)

Protection rating (EN 60529):

IP66

Shock resistance:

50 g (during 11 ms)

Vibration resistance:

35 g (at 2000 Hz)

Cable type:

2 x 0,25: PVC, PUR or silicone

3 x 0,25 PVC

Cable length:

2, 5 or 10 m

Electromagnetic compatibility

according to:

EN 60947-5-2

Materials:

Body: plastic

Cable: see table below

Technical data - Reed switches - additional information see data sheet en 4.3.005

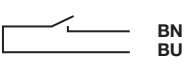
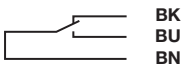
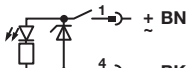
Symbol	Voltage		Current maximum (mA)	Function	Operating temperature (°C)	LED	Protection class	Plug	Cable length (m)	Cable type	Weight (g)	Model
	(VAC)	(VDC)										
	10 ... 240	10 ... 170	180	Normally open	-25 ... +80	•	IP 66	—	2,5 or 10	PVC 2 x 0,25	37	M/50/LSU/*V
	10 ... 240	10 ... 170	180	Normally open	-25 ... +80	•	IP 66	—	5	PUR 2 x 0,25	37	M/50/LSU/SU
	10 ... 240	10 ... 170	180	Normally open	-25 ... +150	—	IP 66	—	2	Silicon 2 x 0,25	37	TM/50/RAU/2S
	10 ... 240	10 ... 170	180	Changeover	-25 ... +80	—	IP 66	—	5	PVC 3 x 0,25	37	M/50/RAC/5V
	10 ... 60	10 ... 60	180	Normally open	-25 ... +80	•	IP 66	M8 x1	0,3	PVC 3 x 0,25	16	M/50/LSU/CP *1)
	10 ... 60	10 ... 60	180	Normally open	-25 ... +80	•	IP 66	M12 x1	0,3	PVC 3 x 0,25	16	M/50/LSU/CC *1)

* Insert cable length; *1) Plug-in connector see page 24

M/50/LSU/*V, M/50/LSU/5U,
TM/50/RAU/2S
Cable length L = 2, 5 or 10 m

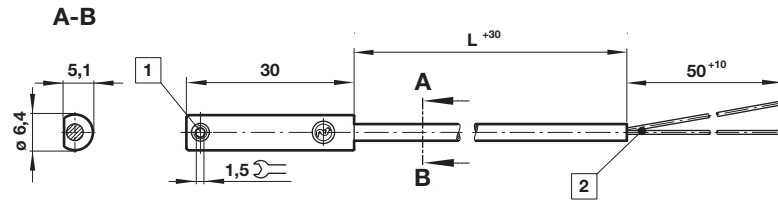

M/50/RAC/5V
Cable length L = 5 m

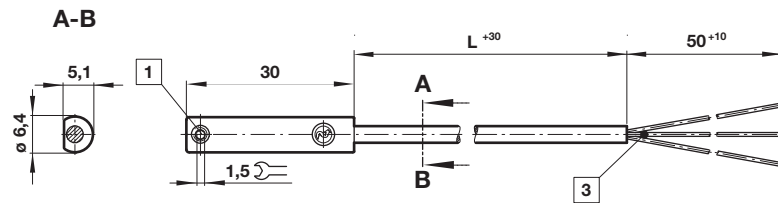

M/50/LSU/CP
M/50/LSU/CC

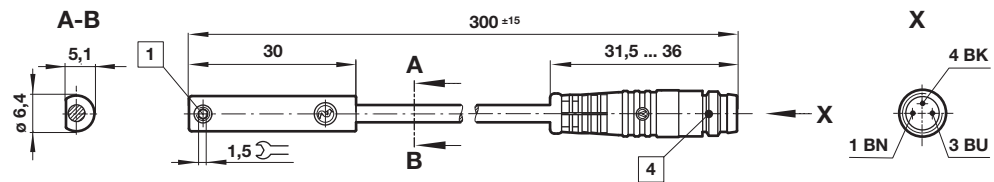

- 1 Fixing screw
- 2 + BN = brown; - BU = blue (output)
- 3 - BK = black; + BN = brown; - BU = blue
- 4 Version CP: Plug M8 x 1, color code: BK = +; BN = -; BU = output
Version CC: Plug M12 x 1, color code: BK = +; BN = -; BU = output

Accessories

Plug-in connector cable with nut



Outer cover	Cable length (m)	Weight (kg)	Connector	Connector
PVC 3 x 0,25	5	0,18	M8 x 1	M/P73001/5
PUR 3 x 0,25	5	0,18	M8 x 1	M/P73002/5
PUR 3 x 0,34	5	0,21	M12 x 1	M/P34594/5

- > Magnetically operated solid state switch - round style
- > IO-Link version available
- > Suitable for all cylinder ranges with magnetic piston
- > Switches can be mounted flush in all profile cylinders
- > Reliable switching with a very fast reponse time
- > Particularly suited for use in high levels of vibration
- > LED indicator as standard
- > CE certified
- > UL listed

 **IO-Link**



Technical features

Operation:

M/50/EAP (PNP) open collector output with LED (yellow)

M/50/EAN (NPN) grounded emitter output with LED (yellow)

M/50/IOP (PNP) Easy IO-Link open collector output with LED (yellow)

Switching voltage (Ub):

10 ... 30 VDC

Switching voltage output:

Ub - 2 V

Inducted voltage:

0,5 V

Switching current (see graph overleaf):

100 mA max.

Switching power:

3,0 W max.

Response time:

< 0,5 ms for EAP switch

< = 1 ms for IOP switch

Operating frequency:

1 kHz

Protection rating (EN 60529):

IP67 (standard)

IP68 for type: M/50/EAP/5U

Operating temperature:

-40 ... +80 °C (-40 ... 176 °F)
(IP67 & IP68)

Cable type:

PVC 3 x 0,12 (standard)

PUR 3 x 0,14 (M/50/EAP/5U)

Cable length:

2, 5 and 10 m

Electromagnetic compatibility according to:

EN 60947-5-2

Materials:

Body: plastic

Cable: see table below

Technical data - Solid state

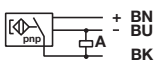
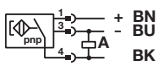
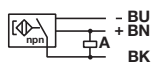
Symbol	Voltage (VDC)	Current maximum (mA)	Function	IO-Link *2)	Operating temperature (°C)	LED	Protection class	Plug	Cable length (m)	Cable type	Weight (g)	Model
	10 ... 30	100	PNP		-40 ... +80	•	IP67	—	2,5 or 10	PVC 3x0,12	37	M/50/EAP/*V
	10 ... 30	100	PNP	•	-40 ... +80	•	IP67	—	5	PVC 3x0,12	37	M/50/IOP/5V
	10 ... 30	100	PNP		-40 ... +80	•	IP68	—	5	PUR 3x0,14	37	M/50/EAP/5U
	10 ... 30	100	PNP		-40 ... +80	•	IP67	M8x1	0,3	PVC 3x0,14	16	M/50/EAP/CP *1)
	10 ... 30	100	PNP	•	-40 ... +80	•	IP67	M8x1	0,3	PVC 3x0,14	16	M/50/IOP/CP *1)
	10 ... 30	100	PNP		-40 ... +80	•	IP67	M12x1	0,3	PVC 3x0,14	16	M/50/EAP/CC *1)
	10 ... 30	100	NPN		-40 ... +80	•	IP67	—	2,5 or 10	PVC 3x0,12	37	M/50/EAN/*V
	10 ... 30	100	NPN		-40 ... +80	•	IP67	M8x1	0,3	PVC 3x0,14	16	M/50/EAN/CP *1)

* Insert cable length; *1) Plug-in connector below; Color code: BK = black, BN = brown, BU = blue

IO-Link function *2)

- Visual installation aid
- Counter
- Temperature diagnostic
- Power LED

Switching current and switching voltage

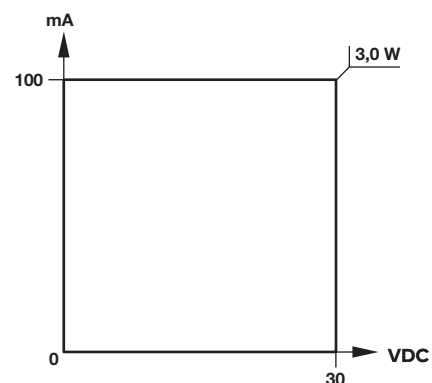

Dimensions

M/50/EAP/*V,
M/50/EAN/*V
M/50/IOP/5V
Cable length L = 2, 5 or 10 m

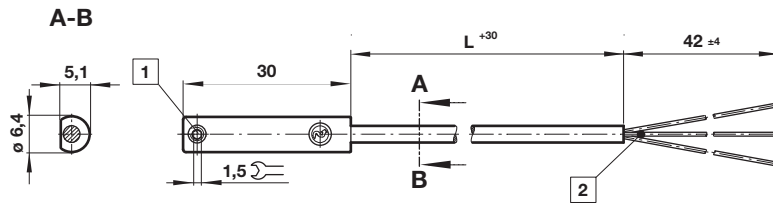

Dimensions in mm
Projection/First angle



M/50/EAP/CP,
M/50/EAN/CP
M/50/IOP/CP

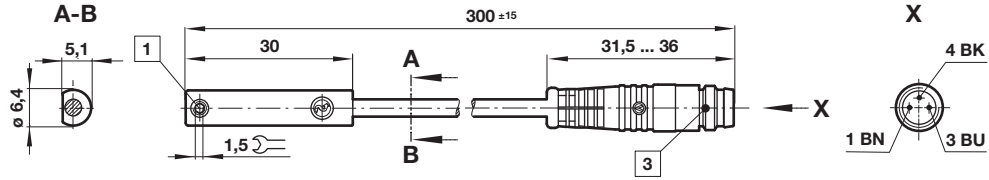

M/50/EAP/CC

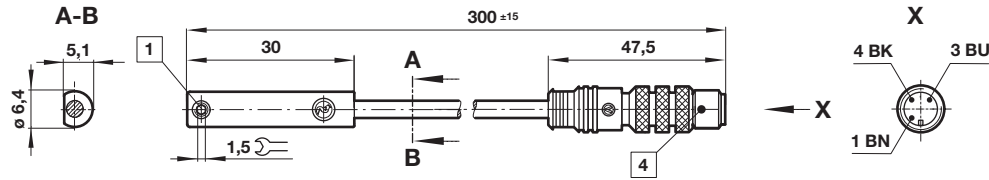

- 1 Fixing screw
- 2 Color code: BK = black; BN = brown; BU = blue
- 3 Plug M8 x 1
- 4 Plug M12 x 1

Accessories

Plug-in connector cable with nut









Outer cover	Cable length (m)	Weight (kg)	Connector	Connector
PVC 3 x 0,25	5	0,18	M8 x 1	M/P73001/5*1)
PUR 3 x 0,25	5	0,18	M8 x 1	M/P73002/5*1)
PVC 3 x 0,25	5	0,18	M8 x 1	M/P34615/5*2)
PUR 3 x 0,25	5	0,18	M8 x 1	M/P34596/5*2)
PUR 3 x 0,34	5	0,21	M12 x 1	M/P34594/5*1)

*1) Straight connector

*2) 90 ° Connector

Bus card



Description	SI-PROFINET RT V2	SI-PROFIBUS	SI-EtherNet/IP	SI-EtherCAT	SI-CANopen	SI-DeviceNet
						
Color code	Green	Purple	Cream	Red	White	Grey
Model	QE/B18200/PN	QE/B17500/PB	QE/B17900/EN	QE/B18000/EC	QE/B17600/CO	QE/B17700/DN

Description SI-I/O
 Extended I/O interface module to increase the number of analog and digital In- and Outputs on the drive.





Color code Orange
Model QE/B17800/IO





Power cable

Description	Motor cable without brake	Motor cable with brake
		
Cable length	5 m 10 m	5 m 10 m
Model	QE/C5402/08/5 QE/C5402/08/10	QE/C5402/18/5 QE/C5402/18/10

Feedback cable

Description	Feedback cable resolver	Feedback cable Multi Turn
		
Cable length	5 m 10 m	5 m 10 m
Model	QE/F5400/61/5 QE/F5400/61/10	QE/F5400/30/5 QE/F5400/30/10

Drive accessories

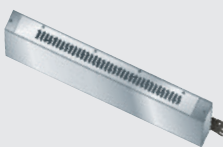
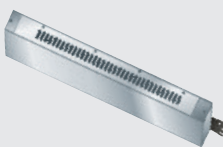
Multiple axis kit short  QE/A9500/1047	long  QE/A9500/1048	USB converter cable  QE/A4500/0096	KI compact display  QE/A20400	EMC filter for	QE/D01400030  QE/A4200/8744	QE/D02400105  QE/A4200/1644
--	---	--	---	-----------------------	---	---

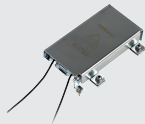
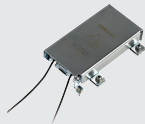
Brake resistor for 50 W  QE/A9500/1049	100 W  QE/A1220/2801
--	--

Warning

These products should only be used where the values listed under **"Technical features/data"** are not exceeded. Please refer to the corresponding catalogue page. Before using the products in non-industrial applications, in life-support or other systems not included in the published instructions, please contact Norgren directly. Misuse, wear, or malfunction can cause components to fail in a variety of ways.

System designers are strongly recommended to consider the failure modes of all component parts used and to take adequate safety precautions to prevent personal injury and damage to equipment in the event of such failure. System designers and end users are cautioned to review specific warnings found in instruction sheets packed and shipped with these products.